

Canon

EOS 70D

EOS 70D (W)

EOS 70D (N)



The EOS 70D (N) does not have the Wi-Fi function explained in this manual.

E

**INSTRUCTION
MANUAL**

Introduction

The EOS 70D (W/N) is a high-performance, digital single-lens reflex camera featuring a fine-detail CMOS sensor with approx. 20.2 effective megapixels, DIGIC 5+, high-precision and high-speed 19-point AF (all cross-type focusing), approx. 7.0 fps continuous shooting, Live View shooting, Full High-Definition (Full HD) movie shooting, and Wi-Fi function*.

The camera is highly responsive to any shooting situation at any time, provides many features for demanding shots, and expands shooting possibilities with various system accessories.

* The EOS 70D (N) does not have the Wi-Fi function.

Refer to This Manual while Using the Camera to Further Familiarize Yourself with the Camera

With a digital camera, you can immediately view the image you have captured. While reading this manual, take a few test shots and see how they come out. You can then better understand the camera.

To avoid botched pictures and accidents, first read the “Safety Warnings” (p.445-447) and “Handling Precautions” (p.18, 19).

Testing the Camera Before Use and Liability

After shooting, play images back and check whether they have been properly recorded. If the camera or memory card is faulty and the images cannot be recorded or downloaded to a computer, Canon cannot be held liable for any loss or inconvenience caused.

Copyrights

Copyright laws in your country may prohibit the use of your recorded images or copyrighted music and images with music in the memory card for anything other than private enjoyment. Also be aware that certain public performances, exhibitions, etc., may prohibit photography even for private enjoyment.

Compatible Cards

The camera can use the following cards regardless of capacity:

- SD memory cards
- SDHC memory cards*
- SDXC memory cards*

* UHS-I cards supported.

Cards that Can Record Movies

When shooting movies, use a large-capacity card with a fast reading/writing speed as shown in the table.

Compression Method (p.265)	Card
IPB	6 MB/sec. or faster
ALL-I (I-only)	20 MB/sec. or faster

- If you use a slow-writing card when shooting movies, the movie may not be recorded properly. Also, if you play back a movie on a card with a slow reading speed, the movie may not play back properly.
- If you want to shoot still photos while shooting a movie, you will need an even faster card.
- To check the card's reading/writing speed, refer to the card manufacturer's Web site.



In this manual, "card" refers to SD memory cards, SDHC memory cards, and SDXC memory cards.

* **The camera does not come with a card for recording images/movies.** Please purchase it separately.

Item Check List

Before starting, check that all the following items have been included with your camera. If anything is missing, contact your dealer.



Camera
(with body cap)



**Battery Pack
LP-E6**
(with protective cover)



**Battery Charger
LC-E6/LC-E6E***

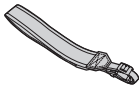

**Wide Strap
EW-EOS70D**



Interface Cable

* Battery Charger LC-E6 or LC-E6E is provided. (The LC-E6E comes with a power cord.)

- The Instruction Manuals and CD-ROMs provided are listed on the next page.
- If you purchased a Lens Kit, check that the lenses are included.
- Depending on the Lens Kit type, a lens instruction manual may also be included.
- Be careful not to lose any of the above items.

Instruction Manual and CD-ROMs

The instruction manual consists of booklets and electronic manuals (PDF files on the CD-ROM). **Basic operations are explained in the booklets. For detailed instructions on all functions and operations, see the detailed version manuals on the CD-ROM.**



**Camera Basic
Instruction Manual**



**Wi-Fi Function
Instruction Manual***
(Basic)



Quick Reference Guide



Wi-Fi Cautions*

* Not provided with the EOS 70D (N).



Camera Instruction Manual CD-ROM

Contains the following manuals in PDF:

- Camera Instruction Manual (Detailed version)
- Wi-Fi Function Instruction Manual (Detailed version)
- Quick Reference Guide

Instructions for viewing the Camera Instruction Manual CD-ROM are on page 452.



Software CD-ROM (EOS DIGITAL Solution Disk)

Contains various software. For outlines and installation procedure of the software, see pages 456-458.



Software Instruction Manual CD-ROM

Contains software manuals in PDF. Instructions for viewing the Software Instruction Manual CD-ROM are on page 459.

Quick Start Guide

1

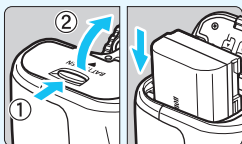

Insert the battery (p.30).

- To charge the battery, see page 28.

2

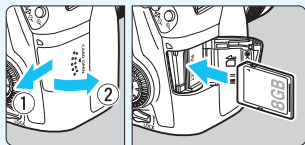

Insert a card (p.31).

- With the card's label facing toward the back of the camera, insert it into the card slot.

3

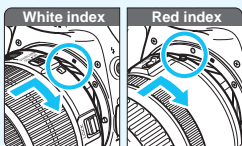

Attach the lens (p.40).

- Align the lens' white or red mount index with the camera's mount index of the same color.

4

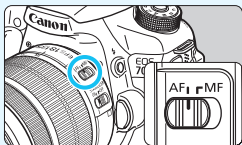

Set the lens focus mode switch to <AF> (p.40).

5

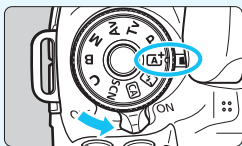

Set the power switch to <ON>, then set the Mode Dial to <A+> (Scene Intelligent Auto) (p.72).

- Turn the Mode Dial while holding down the lock release button at the center.
- All the necessary camera settings will be set automatically.

6

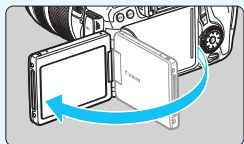
**Flip out the LCD monitor** (p.34).

- When the LCD monitor displays the date/time/zone setting screens, see page 37.

7

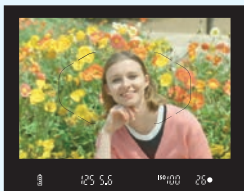
**Focus the subject** (p.45).

- Look through the viewfinder and aim the viewfinder center over the subject.
- Press the shutter button halfway. The camera will focus the subject.
- If necessary, the built-in flash will be raised.

8

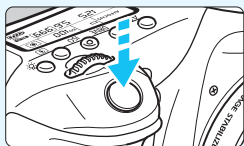
**Take the picture** (p.45).

- Press the shutter button completely to take the picture.

9





**Review the picture** (p.60).

- The captured image will be displayed for 2 sec. on the LCD monitor.
- To display the image again, press the <▶> button (p.290).





- To shoot while looking at the LCD monitor, see “Live View Shooting” (p.215).
- To view the images captured so far, see “Image Playback” (p.290).
- To delete an image, see “Erasing Images” (p.322).

Conventions Used in this Manual

Icons in this Manual

-  : Indicates the Main Dial.
-  : Indicates the Quick Control Dial.
-  : Indicates the Multi-controller and the push direction.
-  : Indicates the Setting button.
-  : Indicates that the corresponding function remains active for 4 sec., 6 sec., 10 sec., or 16 sec. respectively after you let go of the button.

* In this manual, the icons and markings indicating the camera's buttons, dials, and settings correspond to the icons and markings on the camera and on the LCD monitor.

- MENU** : Indicates a function that can be changed by pressing the **<MENU>** button and changing the setting.
- ★ : When shown on the upper right of a page, it indicates that the function is available only in the Creative Zone modes (p.24).
- (p.**)
-  : Warning to prevent shooting problems.
-  : Supplemental information.
-  : Tips or advice for better shooting.
-  : Problem-solving advice.

Basic Assumptions

- All operations explained in this manual assume that the power switch is set to **<ON>** and the **<LOCK>** switch is set down (Multi function lock released) (p.35, 48).
- It is assumed that all the menu settings and Custom Functions are set to their defaults.
- The illustrations in this manual show the camera attached with the EF-S18-135mm f/3.5-5.6 IS STM lens as an example.

Chapters

For first-time DSLR users, Chapters 1 and 2 explain the camera's basic operations and shooting procedures.





	Introduction	2
1	Getting Started	27
2	Basic Shooting	71
3	Setting the AF and Drive Modes	99
4	Image Settings	115
5	Advanced Operations	157
6	Flash Photography	187
7	Shooting with the LCD Monitor (Live View Shooting)	215
8	Shooting Movies	251
9	Image Playback	289
10	Post-Processing Images	327
11	Sensor Cleaning	339
12	Printing Images	345
13	Customizing the Camera	361
14	Reference	393
15	Viewing the CD-ROM Instruction Manuals / Downloading Images to Your Computer	451

Contents













Introduction 2

Compatible Cards.....	3
Item Check List.....	4
Instruction Manual and CD-ROMs	5
Quick Start Guide	6
Conventions Used in this Manual.....	8
Chapters.....	9
Index to Features	16
Handling Precautions	18
Nomenclature	20



1 Getting Started 27

Charging the Battery	28
Installing and Removing the Battery.....	30
Installing and Removing the Card	31
Using the LCD Monitor	34
Turning on the Power	35
Setting the Date, Time, and Zone	37
Selecting the Interface Language.....	39
Attaching and Detaching a Lens	40
Lens Image Stabilizer.....	43
Basic Operation.....	44
 Quick Control for Shooting Functions.....	50
 Menu Operations.....	52
 Using the Touch Screen.....	54
Before You Start.....	57
Formatting the Card.....	57
Disabling the Beeper	59
Setting the Power-off Time/Auto Power Off	59
Setting the Image Review Time	60
Turning the LCD Monitor Off/On.....	60
Reverting the Camera to the Default Settings	61
Displaying the Grid	64
 Displaying the Electronic Level.....	65
Feature Guide and Help	69

2 Basic Shooting 71



 Fully Automatic Shooting (Scene Intelligent Auto)	72
 Full Auto Techniques (Scene Intelligent Auto)	75
 Disabling Flash	77
 Creative Auto Shooting	78
SCN : Special Scene Mode	81
 Shooting Portraits	82
 Shooting Landscapes	83
 Shooting Close-ups	84
 Shooting Moving Subjects	85
 Shooting Night Portraits (With a Tripod)	86
 Shooting Night Scenes (Handheld)	87
 Shooting Backlit Scenes	88
 Quick Control	90
Shoot by Ambience Selection	92
Shoot by Lighting or Scene Type	96

3 Setting the AF and Drive Modes 99







AF: Selecting the AF Operation	100
 Selecting the AF Area	103
AF Area Selection Modes	106
When Autofocus Fails	109
MF: Manual Focus	110
 Selecting the Drive Mode	111
 Using the Self-timer	113

4 Image Settings 115







Setting the Image-Recording Quality	116
ISO: Setting the ISO Speed	120
 Selecting a Picture Style	126
 Customizing a Picture Style	129
 Registering a Picture Style	132

Setting the White Balance	134
 Custom White Balance.....	135
 Setting the Color Temperature	137
White Balance Correction.....	138
Auto Correction of Brightness and Contrast.....	140
Setting Noise Reduction.....	141
Highlight Tone Priority	145
Lens Peripheral Illumination / Chromatic Aberration Correction ..	146
Creating and Selecting a Folder	149
File Numbering Methods	151
Setting Copyright Information.....	153
Setting the Color Space	155



5 Advanced Operations 157

P : Program AE	158
Tv : Shutter-Priority AE.....	160
Av : Aperture-Priority AE	162
Depth-of-Field Preview	163
M : Manual Exposure	164
 Selecting the Metering Mode.....	165
Setting Exposure Compensation.....	167
 Auto Exposure Bracketing (AEB).....	168
 AE Lock.....	170
B : Bulb Exposures.....	171
HDR : HDR (High Dynamic Range) Shooting	172
 Multiple Exposures	175
 Mirror Lockup	182
Using the Eyepiece Cover	183
 Using a Remote Switch	184
 Remote Control Shooting.....	184

6	Flash Photography	187
	⚡ Using the Built-in Flash	188
	⚡ Using an External Speedlite.....	193
	Setting the Flash	195
	Using Wireless Flash	203
7	Shooting with the LCD Monitor (Live View Shooting)	215
	📷 Shooting with the LCD Monitor	216
	Shooting Function Settings	222
	🌀 Shooting with Filter Effects.....	224
	Menu Function Settings	228
	Using AF to Focus (AF Method)	233
	👉 Shooting with the Touch Shutter	245
	MF: Focusing Manually	247
8	Shooting Movies	251
	🎬 Shooting Movies	252
	Shooting Function Settings	263
	Setting the Movie Recording Size	265
	Using Movie Digital Zoom	267
	Setting the Sound Recording	268
	Setting the Time Code	270
	Menu Function Settings	273
	Shooting Video Snapshots.....	277
9	Image Playback	289
	▶ Image Playback	290
	INFO.: Shooting Information Display	292
	🔍 🔍 Searching for Images Quickly	296
	🔍/🔍 Magnified View	298
	👉 Playing Back with the Touch Screen	299
	🔄 Rotating the Image	301

Setting Ratings	302
 Quick Control for Playback	304
 Enjoying Movies	306
 Playing Movies	308
 Editing a Movie's First and Last Scenes	310
Slide Show (Auto Playback)	312
Viewing Images on a TV Set	316
 Protecting Images	320
 Erasing Images	322
Changing Image Playback Settings	324
Adjusting the LCD Monitor Brightness	324
Auto Rotation of Vertical Images	325





10 Post-Processing Images 327

 Processing RAW Images with the Camera	328
 Resizing JPEG Images	333
 Applying Creative Filters	335

11 Sensor Cleaning 339

 Automatic Sensor Cleaning	340
Appending Dust Delete Data	341
Manual Sensor Cleaning	343

12 Printing Images 345

Preparing to Print	346
 Printing	348
 Digital Print Order Format (DPOF)	355
 Direct Printing of Print-Ordered Images	358
 Specifying Images for a Photobook	359

13 Customizing the Camera 361

Setting Custom Functions	362
Custom Functions	363

Custom Function Settings.....	365
C.Fn I: Exposure	365
C.Fn II: Autofocus	368
C.Fn III: Operation/Others.....	375
☛: Fine Adjustment of AF's Point of Focus	377
☛: Custom Controls	383
Registering My Menu	389
C : Register Custom Shooting Modes.....	390

14 Reference 393

INFO. Button Functions.....	394
Checking the Battery Information.....	396
Using a Household Power Outlet.....	400
📶 Using Eye-Fi Cards	401
Function Availability Table According to Shooting Mode	404
Menu Settings	408
System Map	416
Troubleshooting Guide.....	418
Error Codes.....	432
Specifications	433
Handling Precautions: EF-S18-55mm f/3.5-5.6 IS STM, EF-S18-135mm f/3.5-5.6 IS STM	443
Safety Warnings.....	445

15 Viewing the CD-ROM Instruction Manuals / Downloading Images to Your Computer 451

Viewing the Camera Instruction Manual CD-ROM	452
Downloading Images to a Computer.....	454
Software Overview.....	456
Installing the Software.....	458
Software Instruction Manual	459
Index	460

Index to Features

Power

- Charging the battery → p.28
- Battery check → p.36
- Battery information check → p.396
- Household power outlet → p.400
- Auto power off → p.59

Card

- Formatting → p.57
- Release shutter without card → p.32

Lens

- Attaching/Detaching → p.40
- Zoom → p.41
- Image Stabilizer → p.43

Basic Settings

- Language → p.39
- Date/Time/Zone → p.37
- Beeper → p.59
- Copyright information → p.153
- Clear all camera settings → p.61

Viewfinder

- Dioptic adjustment → p.44
- Eyepiece cover → p.183
- Electronic level (During shooting) → p.66
- Electronic level (Before shooting) → p.67

LCD Monitor

- Brightness adjustment → p.324
- Touch screen → p.54
- Electronic level → p.65
- Feature guide → p.69
- Help → p.70

AF

- AF operation → p.100

- AF area selection mode → p.103
- AF point selection → p.105
- AF Microadjustment → p.377
- Manual focusing → p.110

Metering

- Metering mode → p.165

Drive

- Drive mode → p.111
- Self-timer → p.113
- Maximum burst → p.119

Recording Images

- Creating/Selecting a folder → p.149
- File numbering → p.151

Image Quality

- Image-recording quality → p.116
- ISO speed → p.120
- Picture Style → p.126
- White balance → p.134
- Auto Lighting Optimizer → p.140
- Noise reduction for high ISO speeds → p.141
- Noise reduction for long exposures → p.143
- Highlight tone priority → p.145
- Peripheral illumination correction → p.146
- Chromatic aberration correction → p.147
- Color space → p.155

Shooting

- Shooting mode → p.24
- HDR → p.172
- Multiple exposures → p.175
- Mirror lockup → p.182
- Depth-of-field preview → p.163

- Remote control → p.184
- Quick Control → p.50

Exposure Adjustment

- Exposure compensation → p.167
- AEB → p.168
- AE lock → p.170
- Safety shift → p.367

Flash

- Built-in flash → p.188
- External flash → p.193
- Flash function settings → p.195
- Wireless shooting → p.203

Live View Shooting

- Live View shooting → p.215
- Focusing → p.233
- Continuous AF → p.228
- Aspect ratio → p.229
- Creative filters → p.224
- Touch Shutter → p.245

Movie Shooting

- Movie shooting → p.251
- Movie Servo AF → p.273
- Movie recording size → p.265
- Digital zoom → p.267
- Sound recording → p.268
- Time code → p.270
- Still photo shooting → p.261
- Video snapshot → p.277

Playback

- Image review time → p.60
- Single-image display → p.290
- Shooting information display → p.292
- Index display → p.296
- Image browsing (Jump display) → p.297

- Magnified view → p.298
- Image rotate → p.301
- Rating → p.302
- Movie playback → p.308
- Slide show → p.312
- Viewing images on a TV set → p.316
- Protect → p.320
- Erase → p.322
- Touch playback → p.299

Image Editing

- RAW image processing → p.328
- Resize → p.333
- Creative filters → p.335

Printing

- PictBridge → p.345
- Print Order (DPOF) → p.355
- Photobook Set-up → p.359

Customization

- Custom Functions (C.Fn) → p.362
- Custom Controls → p.383
- My Menu → p.389
- Custom shooting mode → p.390

Sensor Cleaning and Dust Reduction

- Sensor cleaning → p.340
- Append Dust Delete Data → p.341

Software

- Overview → p.456
- Installation → p.458

Wi-Fi*

- Wi-Fi → Separate booklet

* The EOS 70D (N) does not have the Wi-Fi function.

Handling Precautions

Camera Care

- This camera is a precision instrument. Do not drop it or subject it to physical shock.
- The camera is not waterproof and cannot be used underwater. If you accidentally drop the camera into water, promptly consult the nearest Canon Service Center. Wipe off any water droplets with a dry and clean cloth. If the camera has been exposed to salty air, wipe it with a well-wrung wet cloth.
- Never leave the camera near anything having a strong magnetic field such as a magnet or electric motor. Also avoid using or leaving the camera near anything emitting strong radio waves, such as a large antenna. Strong magnetic fields can cause camera misoperation or destroy image data.
- Do not leave the camera in excessive heat, such as in a car in direct sunlight. High temperatures can cause the camera to malfunction.
- The camera contains precision electronic circuitry. Never attempt to disassemble the camera yourself.
- Do not block the mirror operation with your finger, etc. Doing so may cause a malfunction.
- Use a blower to blow away dust on the lens, viewfinder, reflex mirror, and focusing screen. Do not use cleaners that contain organic solvents to clean the camera body or lens. For stubborn dirt, take the camera to the nearest Canon Service Center.
- Do not touch the camera's electrical contacts with your fingers. This is to prevent the contacts from corroding. Corroded contacts can cause camera misoperation.
- If the camera is suddenly brought in from the cold into a warm room, condensation may form on the camera and internal parts. To prevent condensation, first put the camera in a sealed plastic bag and let it adjust to the warmer temperature before taking it out of the bag.
- If condensation forms on the camera, do not use the camera. This is to avoid damaging the camera. If there is condensation, remove the lens, card and battery from the camera, and wait until condensation has evaporated before using the camera.
- If the camera will not be used for an extended period, remove the battery and store the camera in a cool, dry, well-ventilated location. Even while the camera is in storage, press the shutter button a few times once in a while to check that the camera is still working.
- Avoid storing the camera where there are chemicals that result in rust and corrosion such as in a chemical lab.

- If the camera has not been used for an extended period, test all its functions before using it. If you have not used the camera for some time or if there is an important shoot such as a foreign trip coming up, have the camera checked by your Canon dealer or check the camera yourself and make sure it is working properly.
- If you use continuous shooting, Live View shooting, or movie shooting for a prolonged period, the camera may become hot. This is not a malfunction.

LCD Panel and LCD Monitor

- Although the LCD monitor is manufactured with very high precision technology with over 99.99% effective pixels, there may be a few dead pixels displaying only black or red, etc. among the remaining 0.01% or less pixels. Dead pixels are not a malfunction. They do not affect the images recorded.
- If the LCD monitor is left on for a prolonged period, screen burn-in may occur where you see remnants of what was displayed. However, this is only temporary and will disappear when the camera is left unused for a few days.
- The LCD monitor display may seem slow in low temperatures, or look black in high temperatures. It will return to normal at room temperature.

Cards

To protect the card and its recorded data, note the following:

- Do not drop, bend, or wet the card. Do not subject it to excessive force, physical shock, or vibration.
- Do not touch the card's electronic contacts with your fingers or anything metallic.
- Do not affix any stickers, etc., on the card.
- Do not store or use the card near anything having a strong magnetic field, such as a TV set, speakers, or magnet. Also avoid places prone to having static electricity.
- Do not leave the card in direct sunlight or near a heat source.
- Store the card in a case.
- Do not store the card in hot, dusty, or humid locations.

Lens

After detaching the lens from the camera, put down the lens with the rear end up and attach the lens caps to avoid scratching the lens surface and electrical contacts.



Nomenclature

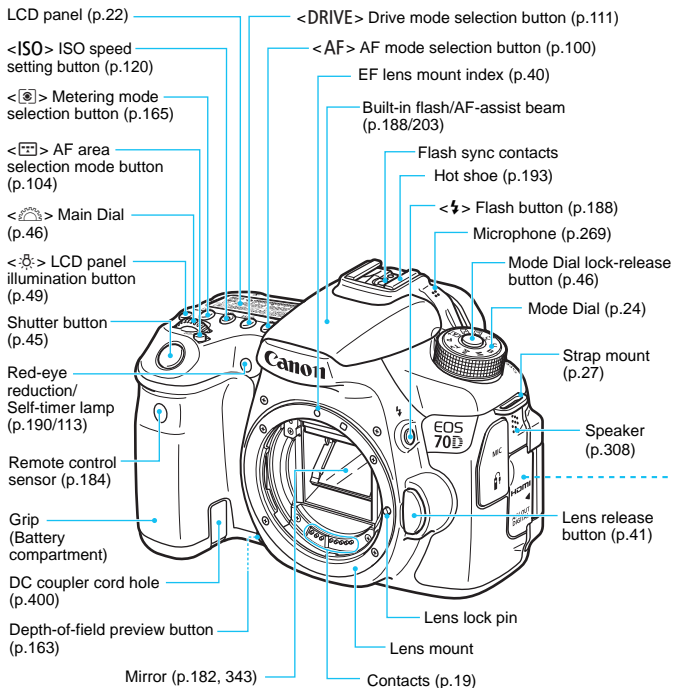

Body cap (p.40)

<MIC> External microphone IN terminal (p.269)

<RC> Remote control terminal (p.184)

<HDMI OUT> HDMI mini OUT terminal (p.316)

<A/V OUT/DIGITAL> Audio/video OUT/Digital terminal (p.319/346, 454)

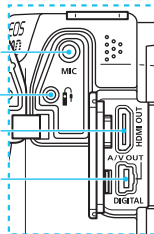

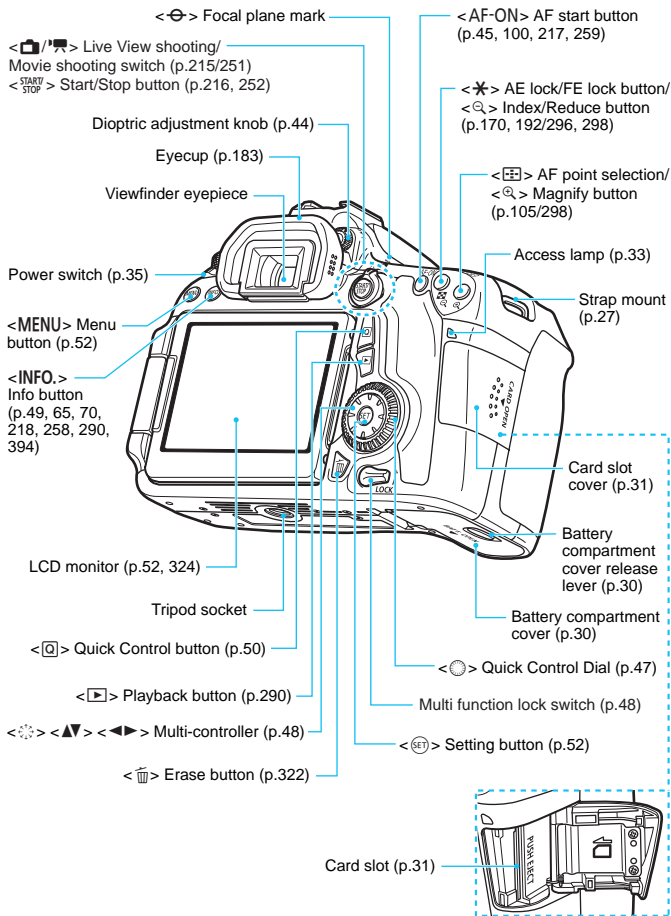

LCD panel

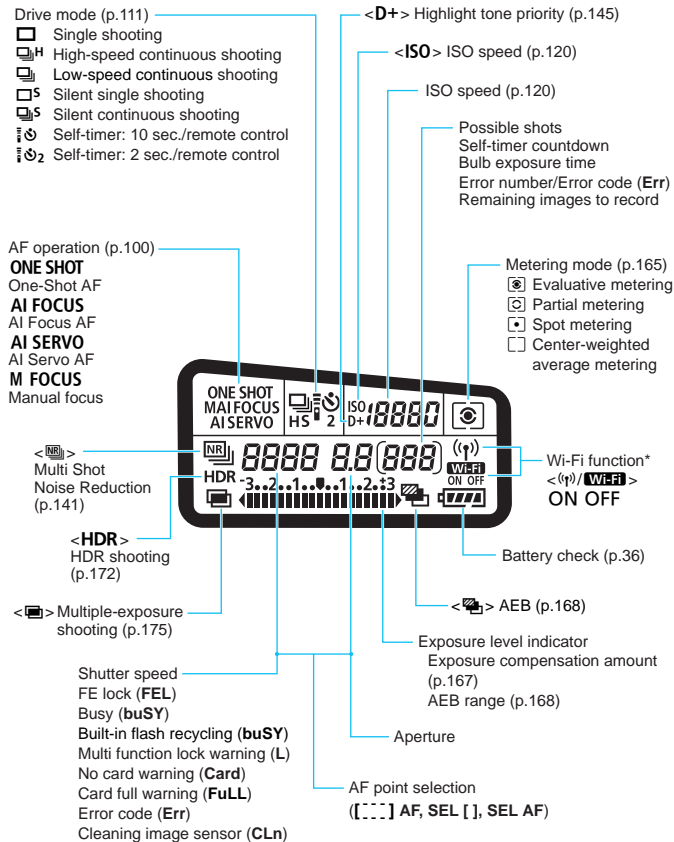

* The EOS 70D (N) does not have the Wi-Fi function (Not Displayed).

* The display will show only the settings currently applied.

Viewfinder Information

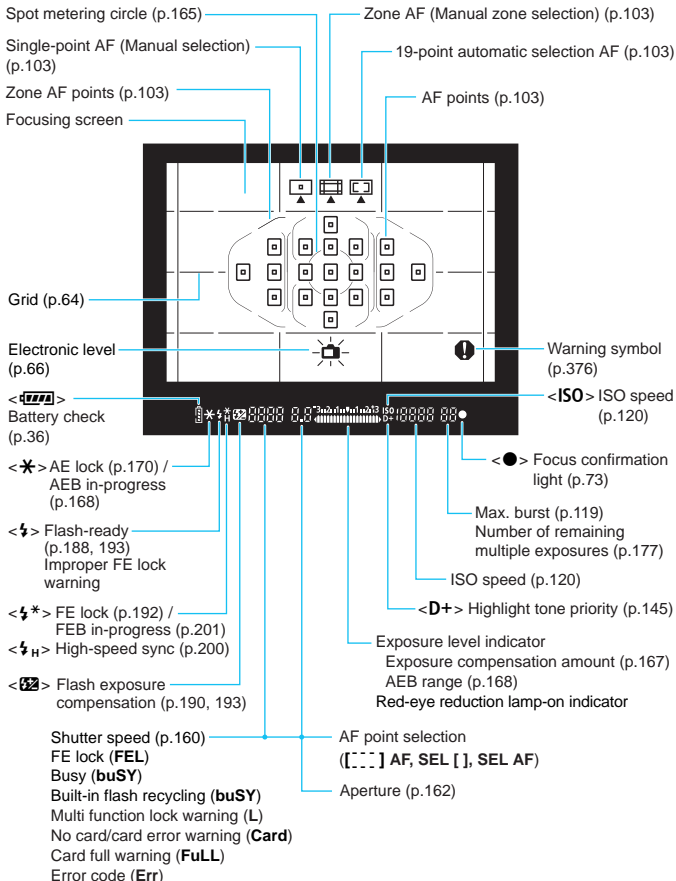

The display will show only the settings currently applied.

Mode Dial

Turn the Mode Dial while holding down the Mode Dial center (Mode Dial lock release button).

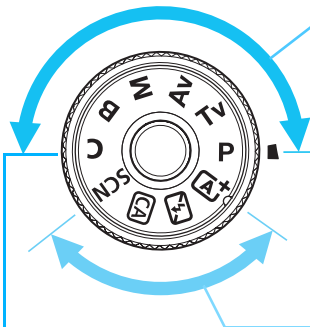

Creative Zone

These modes give you more control for shooting various subjects.

- P** : Program AE (p.158)
- Tv** : Shutter-priority AE (p.160)
- Av** : Aperture-priority AE (p.162)
- M** : Manual exposure (p.164)
- B** : Bulb (p.171)

Basic Zone

All you do is press the shutter button. The camera sets everything to suit the subject or scene.

- A+** : Scene Intelligent Auto (p.72)
- [Flash Off]** : Flash Off (p.77)
- CA** : Creative Auto (p.78)
- SCN** : Special scene (p.81)
 - [Portrait]** : Portrait (p.82)
 - [Landscape]** : Landscape (p.83)
 - [Close-up]** : Close-up (p.84)
 - [Sports]** : Sports (p.85)
 - [Night Portrait]** : Night Portrait (p.86)
 - [Handheld Night Scene]** : Handheld Night Scene (p.87)
 - [HDR Backlight Control]** : HDR Backlight Control (p.88)

Custom shooting mode

You can register the shooting mode (**P/Tv/Av/M/B**), AF operation, menu settings, etc., to **C** and shoot (p.390).

Lens

Lens without a distance scale

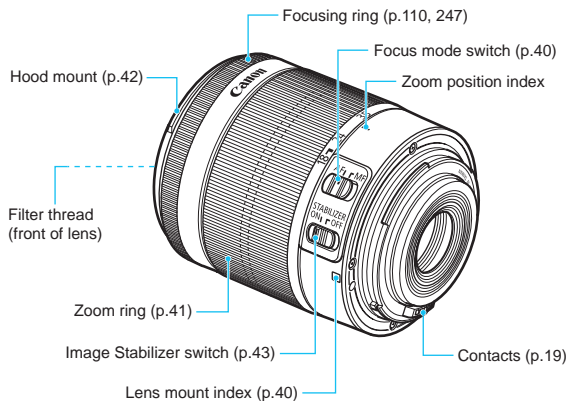

Battery Charger LC-E6

Charger for Battery Pack LP-E6 (p.28).

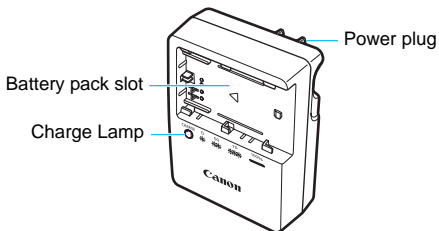

**IMPORTANT SAFETY INSTRUCTIONS-SAVE THESE INSTRUCTIONS.
DANGER-TO REDUCE THE RISK OF FIRE OR ELECTRIC SHOCK,
CAREFULLY FOLLOW THESE INSTRUCTIONS.**

For connection to a supply not in the U.S.A., use an attachment plug adapter of the proper configuration for the power outlet, if needed.

Battery Charger LC-E6E

Charger for Battery Pack LP-E6 (p.28).

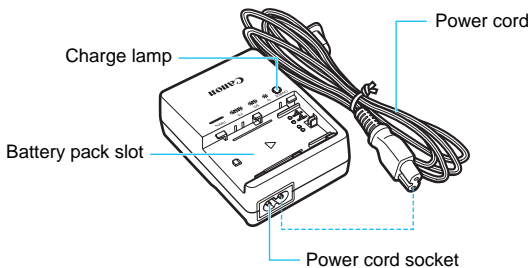

1

Getting Started

This chapter explains preparatory steps before you start shooting and basic camera operations.

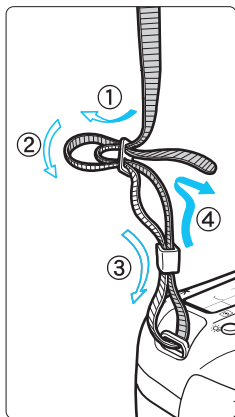

Attaching the Strap

Pass the end of the strap through the camera's strap mount eyelet from the bottom. Then pass it through the strap's buckle as shown in the illustration. Pull the strap to take up any slack and make sure the strap will not loosen from the buckle.

- The eyepiece cover is also attached to the strap (p.183).

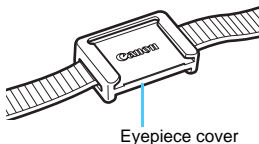

Charging the Battery

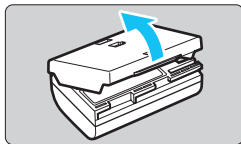

1 Remove the protective cover.

- Detach the protective cover provided with the battery.

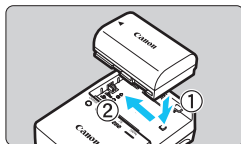

2 Attach the battery.

- As shown in the illustration, attach the battery securely to the charger.
- To detach the battery, follow the above procedure in reverse.

LC-E6

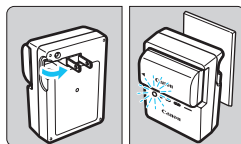

3 Recharge the battery.

For LC-E6

- As shown by the arrow, flip out the battery charger's prongs and insert the prongs into a power outlet.

LC-E6E

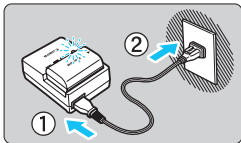

For LC-E6E

- Connect the power cord to the charger and insert the plug into a power outlet.
- ▶ Recharging starts automatically and the charge lamp blinks in orange.

Charge Level	Charge Lamp	
	Color	Display
0-49%	Orange	Blinks once per second
50-74%		Blinks twice per second
75% or higher		Blinks three times per second
Fully charged	Green	Lights up

- It takes approx. 2.5 hours to fully recharge a completely exhausted battery at room temperature (23°C / 73°F). The time required to recharge the battery will vary greatly depending on the ambient temperature and the battery's remaining capacity.
- For safety reasons, recharging in low temperatures (5°C - 10°C / 41°F - 50°F) will take longer (up to approx. 4 hours).

Tips for Using the Battery and Charger

- **Upon purchase, the battery is not fully charged.**
Charge the battery before use.
 - **Recharge the battery on the day before or on the day it is to be used.**
Even during storage, a charged battery will gradually drain and lose its capacity.
 - **After recharging the battery, detach it and disconnect the charger from the power outlet.**
 - **You can attach the cover in a different orientation to indicate whether the battery has been recharged or not.**
If the battery has been recharged, attach the cover so that the battery-shaped hole is aligned over the blue sticker on the battery. If the battery is exhausted, attach the cover in the opposite orientation.
 - **When not using the camera, remove the battery.**
If the battery is left in the camera for a prolonged period, a small amount of power current is released, resulting in excess discharge and shorter battery life. Store the battery with the protective cover attached. Storing the battery when it is fully charged may lower the battery's performance.
 - **The battery charger can also be used in foreign countries.**
The battery charger is compatible with a 100 V AC to 240 V AC 50/60 Hz power source. If necessary, attach a commercially-available plug adapter for the respective country or region. Do not attach any portable voltage transformer to the battery charger. Doing so can damage the battery charger.
 - **If the battery becomes exhausted quickly even after being fully charged, the battery has reached the end of its service life.**
Check the battery's recharge performance (p.396) and purchase a new battery.
- After disconnecting the charger's power plug, do not touch the prongs for approx. 10 sec.
 - If the battery's remaining capacity (p.396) is 94% or higher, the battery will not be recharged.
 - The charger cannot charge any battery other than Battery Pack LP-E6.

Installing and Removing the Battery

Load a fully charged Battery Pack LP-E6 into the camera. The camera's viewfinder becomes bright when a battery is installed, and darkens when the battery is removed.

Installing the Battery

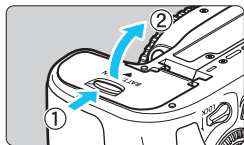

1 Open the cover.

- Slide the lever as shown by the arrows and open the cover.

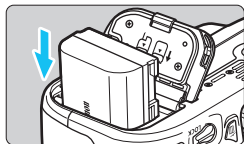

2 Insert the battery.

- Insert the end with the battery contacts.
- Insert the battery until it locks in place.

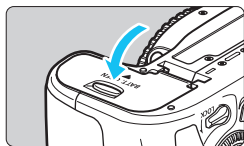

3 Close the cover.

- Press the cover until it snaps shut.

 Only Battery Pack LP-E6 can be used.

Removing the Battery

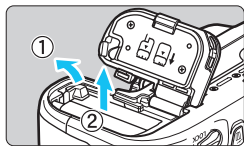

Open the cover and remove the battery.

- Press the battery lock lever as shown by the arrow and remove the battery.
- To prevent short circuiting of the battery contacts, be sure to attach the provided protective cover (p.28) to the battery.

Installing and Removing the Card

The camera can use an SD, SDHC, or SDXC memory card (sold separately). An UHS-I Speed Class SDHC or SDXC memory card can also be used. The captured images are recorded onto the card.

- **Make sure the card's write-protect switch is set upward to enable writing/erasing.**

Installing the Card

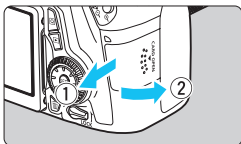

1 Open the cover.

- Slide the cover as shown by the arrows to open it.

Write-protect switch

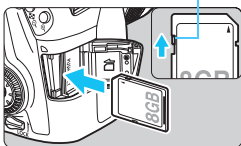

2 Insert the card.

- As shown by the illustration, face the card's label side toward you and insert it until it clicks in place.

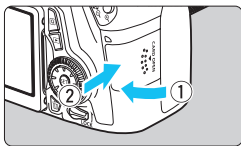

3 Close the cover.

- Close the cover and slide it in the direction shown by the arrows until it snaps shut.
- When you set the power switch to <ON>, the number of possible shots will be displayed on the LCD panel.



Possible shots

- The number of possible shots depends on the remaining capacity of the card, image-recording quality, ISO speed, etc.
- Setting [**1**: **Release shutter without card**] to [**Disable**] will prevent you from forgetting to insert a card (p.408).

Removing the Card

Access lamp

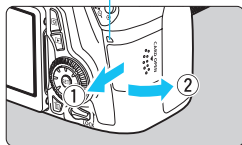

1 Open the cover.

- Set the power switch to <OFF>.
- **Make sure the access lamp is off, then open the cover.**
- If [**Recording...**] is displayed, close the cover.

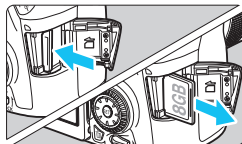

2 Remove the card.

- To eject the card, gently push it in and then let go.
- Pull the card straight out, then close the cover.



- **When the access lamp is lit or blinking, it indicates that images are being written to or read by the card, being erased, or data is being transferred. Do not open the card slot cover during this time. Also, never do any of the following while the access lamp is lit or blinking. Otherwise, it can damage the image data, card, or camera.**
 - **Removing the card.**
 - **Removing the battery.**
 - **Shaking or banging the camera around.**
- If the card already contains recorded images, the image number may not start from 0001 (p.151).
- If a card-related error message is displayed on the LCD monitor, remove and reinsert the card. If the error persists, use a different card. If you can transfer all the images on the card to a computer, transfer all the images and then format the card with the camera (p.57). The card may then return to normal.
- Do not touch the card's contacts with your fingers or metal objects.
- Multimedia cards (MMC) cannot be used (card error will be displayed).

Using the LCD Monitor

After you flip out the LCD monitor, you can set menu functions, use Live View shooting, shoot movies, and play back images and movies. You can change the direction and angle of the LCD monitor.

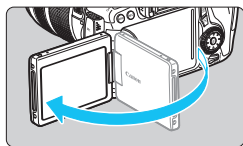

1 Flip out the LCD monitor.

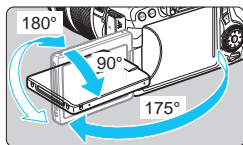

2 Rotate the LCD monitor.

- When the LCD monitor is swung out, you can rotate it up or down or face it forward toward the subject.
- The indicated angles are only approximate.

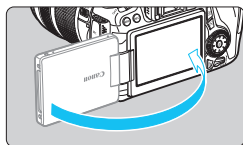

3 Face it toward you.

- Normally, face the LCD monitor toward you.

 Be careful not to force and break the hinge when rotating the LCD monitor.

-  • When not using the camera, close the LCD monitor with the screen facing inward. This will protect the screen.
- During Live View shooting or movie shooting, facing the LCD monitor toward the subject will display a mirror image on the screen.

Turning on the Power

If you turn on the power switch and the date/time/zone setting screen appears, see page 37 to set the date/time/zone.

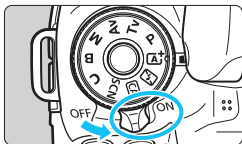

- <ON> : The camera turns on.
- <OFF> : The camera is turned off and does not operate. Set to this position when not using the camera.

Automatic Sensor Cleaning

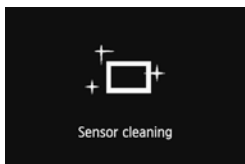

- Whenever you set the power switch to <ON> or <OFF>, sensor cleaning will be executed automatically. (A small sound may be heard.) During the sensor cleaning, the LCD monitor will display <[Sensor Cleaning Icon]>.
- You can still shoot during sensor cleaning by pressing the shutter button halfway (p.45) to stop the sensor cleaning and take a picture.
- If you repeatedly turn the power switch <ON>/<OFF> at a short interval, the <[Sensor Cleaning Icon]> icon may not be displayed. This is normal and not a malfunction.

MENU Auto Power Off

- To save battery power, the camera turns off automatically after 1 minute of non-operation. To turn on the camera again, just press the shutter button halfway (p.45).
- You can set the auto power off time with [**F2: Auto power off**] (p.59).









If you set the power switch to <OFF> while an image is being recorded to the card, [**Recording...**] will be displayed and the power will turn off after the card finishes recording the image.

Checking the Battery Level

When the power switch is set to <ON>, the battery level will be indicated in one of six levels. A blinking battery icon () indicates that the battery will be exhausted soon.



Display						
Level (%)	100 - 70	69 - 50	49 - 20	19 - 10	9 - 1	0



Number of Possible Shots

[Approx. number of shots]

Temperature	Room Temperature (23°C / 73°F)	Low Temperatures (0°C / 32°F)
No Flash	1300	1200
50% Flash Use	920	850

- The figures above are based on a fully-charged Battery Pack LP-E6, no Live View shooting, and CIPA (Camera & Imaging Products Association) testing standards.
- Possible shots with Battery Grip BG-E14
 - With LP-E6 x 2: approx. twice the shots without the battery grip.
 - With size-AA/LR6 alkaline batteries at room temperature (23°C / 73°F): approx. 490 shots with no flash, approx. 320 shots with 50% flash use.



- The number of possible shots will decrease with any of the following operations:
 - Pressing the shutter button halfway for a prolonged period.
 - Activating the AF frequently without taking a picture.
 - Using the lens Image Stabilizer.
 - Using the LCD monitor often.
- The number of possible shots may decrease depending on the actual shooting conditions.
- The lens operation is powered by the camera's battery. Depending on the lens used, the number of possible shots may be lower.
- For the number of possible shots with Live View shooting, see page 217.
- See [**4: Battery info.**] to check the battery's condition in detail (p.396).
- If size-AA/LR6 batteries are used in Battery Grip BG-E14, a four-level indicator will be displayed. (/) will not be displayed.)

MENU Setting the Date, Time, and Zone

When you turn on the power for the first time or if the date/time/zone have been reset, the date/time/zone setting screen will appear. Follow the steps below to set the time zone first. If you set the camera to the correct time zone for where you currently live, when you travel to another time zone you can simply set the camera to the correct time zone for your destination to update the camera's date/time automatically.

Note that the date/time appended to recorded images will be based on this date/time setting. Be sure to set the correct date/time.



1 Display the menu screen.

- Press the <MENU> button to display the menu screen.

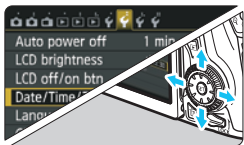

2 Under the [Date/Time/Zone] tab, select [Date/Time/Zone].

- Press the <◀▶> key to select the [Date/Time/Zone] tab.
- Press the <▲▼> key to select [Date/Time/Zone], then press <SET>.

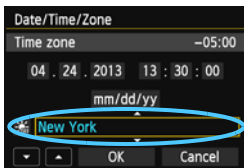

3 Set the time zone.

- [London] is set by default.
- Press the <◀▶> key to select the time zone box.
- Press <SET> so <⏏> is displayed.
- Press the <▲▼> key to select the time zone, then press <SET>. (Returns to <□>.)



- The menu setting procedure is explained on pages 52-53.
- In step 3, the time displayed on the upper right of the screen is the time difference compared with Coordinated Universal Time (UTC). If you do not see your time zone, set the time zone while referring to the difference with UTC.

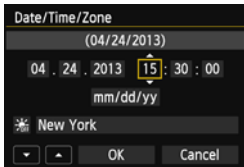

4 Set the date and time.

- Press the <◀▶> key to select the number.
- Press <SET> so <⏸> is displayed.
- Press the <▲▼> key to set the number, then press <SET>. (Returns to <□>.)

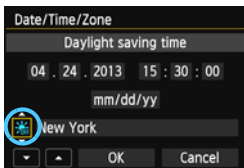

5 Set the daylight saving time.

- Set it if necessary.
- Press the <◀▶> key to select [☀️].
- Press <SET> so <⏸> is displayed.
- Press the <▲▼> key to select [☀️], then press <SET>.
- When the daylight saving time is set to [☀️], the time set in step 4 will advance by 1 hour. If [☀️] is set, the daylight saving time will be canceled and the time will go back by 1 hour.

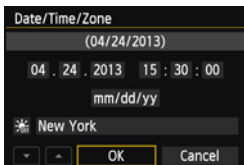

6 Exit the setting.

- Press the <◀▶> key to select [OK], then press <SET>.
- ▶ The date/time/zone and daylight saving time will be set and the menu will reappear.

! If you store the camera without the battery or if the camera's battery becomes exhausted, the date/time/zone may be reset. If this happens, set the time zone and date/time again.

- The date/time that was set will start from when you press <SET> in step 6.
- After changing the time zone, check that the correct date/time has been set.

MENU Selecting the Interface Language



1 Display the menu screen.

- Press the <MENU> button to display the menu screen.

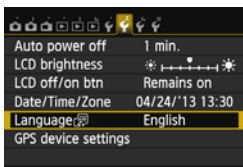

2 Under the [2] tab, select [Language].

- Press the <◀▶> key to select the [2] tab.
- Press the <▲▼> key to select [Language], then press <SET>.

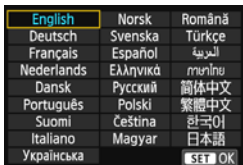
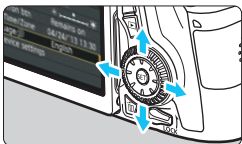

3 Set the desired language.

- Press the <▲▼> <◀▶> keys to select the language, then press <SET>.
- ▶ The interface language will change.

Attaching and Detaching a Lens

The camera is compatible with all Canon EF and EF-S lenses. **The camera cannot be used with EF-M lenses.**

Attaching a Lens

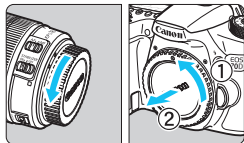

1 Remove the caps.

- Remove the rear lens cap and the body cap by turning them as shown by the arrows.

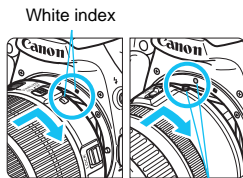

White index

2 Attach the lens.

- Align the lens' red or white mount index with the camera's mount index of the same color. Turn the lens as shown by the arrow until it clicks in place.

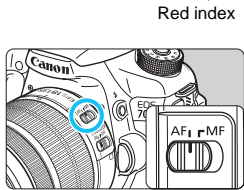

Red index

3 Set the lens focus mode switch to <AF>.

- <AF> stands for autofocus.
- If it is set to <MF> (manual focus), autofocus will not operate.

4 Remove the front lens cap.

Minimizing Dust

- When changing lenses, do it quickly in a place with minimal dust.
- When storing the camera without a lens attached, be sure to attach the body cap to the camera.
- Remove dust on the body cap before attaching it.

Zooming

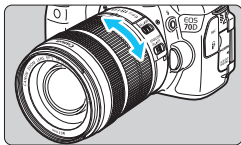

Turn the zoom ring on the lens with your fingers.

- If you want to zoom, do it before focusing. Turning the zoom ring after achieving focus may throw off the focus.

Detaching the Lens

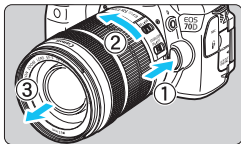

While pressing the lens release button, turn the lens as shown by the arrows.

- Turn the lens until it stops, then detach it.
- Attach the rear lens cap to the detached lens.

● To owners of the EF-S18-200mm f/3.5-5.6 IS lens:

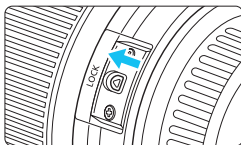

You can prevent the lens from extending out while you are carrying it around. Set the zoom ring to the 18mm wide-angle end, then slide the zoom ring lock lever to **<LOCK>**. The zoom ring can be locked only at the wide-angle end.



- Do not look at the sun directly through any lens. Doing so may cause loss of vision.
- When attaching or detaching a lens, set the camera's power switch to **<OFF>**.
- If the front part (focusing ring) of the lens rotates during autofocus, do not touch the rotating part.
- If you purchased a lens kit with the EF-S18-55mm f/3.5-5.6 IS STM or EF-S18-135mm f/3.5-5.6 IS STM lens, see "Handling Precautions" on page 443.



Image Conversion Factor

Since the image sensor size is smaller than the 35mm film format, it will look like the lens focal length is increased by approx. 1.6x.

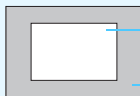

Image sensor size (Approx.)
(22.5 x 15.0 mm / 0.88 x 0.59 in.)

35mm image size
(36 x 24 mm / 1.42 x 0.94 in.)

Attaching a Lens Hood

A lens hood can block unwanted light and diminish rain, snow, dust etc. adhering to the front of the lens. Before storing the lens in a bag, etc., you can attach the hood in reverse.

● If the Lens and the Lens Hood Have a Mount Index

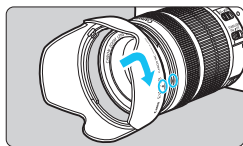

1 Align the red dots on the hood and lens edges, then turn the hood as shown by the arrow.

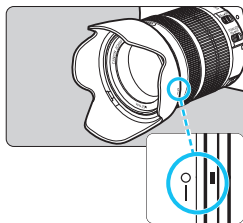

2 Turn the hood as shown in the illustration.

- Turn the hood clockwise until it attaches securely.

- If you do not attach the hood properly, it may obstruct the image's periphery, making it look dark.
- When attaching or detaching the hood, grasp the base of the hood when turning it. Grasping the hood's edges when turning it may deform the hood, resulting in failure to turn.

Lens Image Stabilizer

When you use the IS lens' built-in Image Stabilizer, camera shake is corrected to obtain a sharper shot. The procedure explained here is based on the EF-S18-135mm f/3.5-5.6 IS STM lens as an example.

* IS stands for Image Stabilizer.

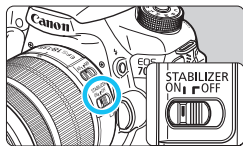

- 1 Set the IS switch to <ON>.**
 - Also set the camera's power switch to <ON>.
- 2 Press the shutter button halfway.**
 - ▶ The Image Stabilizer will operate.
- 3 Take the picture.**
 - When the picture looks steady in the viewfinder, press the shutter button completely to take the picture.

- The Image Stabilizer cannot correct "subject blur", when the subject moves at the time of exposure.
- For bulb exposures, set the IS switch to <OFF>. If <ON> is set, Image Stabilizer misoperation may occur.
- The Image Stabilizer may not be effective for excessive shaking such as on a rocking boat.

- The Image Stabilizer can operate with the lens focus mode switch set to either <AF> or <MF>.
- When using a tripod, you can still shoot with the IS switch set to <ON> with no problem. However, to save battery power, setting the IS switch to <OFF> is recommended.
- The Image Stabilizer is effective even when the camera is mounted on a monopod.
- Some IS lenses enable you to switch the IS mode manually to suit the shooting conditions. However, the following lenses switch the IS mode automatically:
 - EF-S18-55mm f/3.5-5.6 IS STM
 - EF-S18-135mm f/3.5-5.6 IS STM
 - EF-S18-200mm f/3.5-5.6 IS

Basic Operation

Adjusting the Viewfinder Clarity

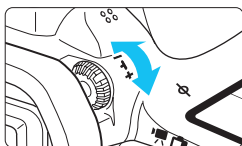

Turn the dioptic adjustment knob.

- Turn the knob left or right so that the AF points in the viewfinder look sharp.
- If the knob is difficult to turn, remove the eyecup (p.183).

 If the camera dioptic adjustment still cannot provide a sharp viewfinder image, using E-series Dioptic Adjustment Lenses (sold separately) is recommended.

Holding the Camera

To obtain sharp images, hold the camera still to minimize camera shake.

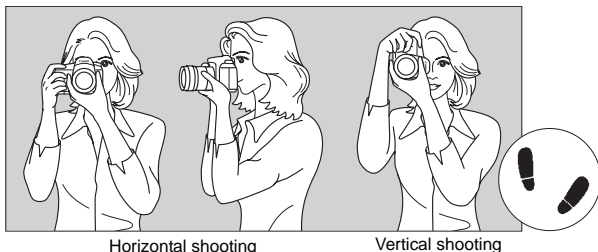

Horizontal shooting

Vertical shooting

1. Wrap your right hand around the camera grip firmly.
2. Hold the lens bottom with your left hand.
3. Rest your hand's right index finger lightly on the shutter button.
4. Press your arms and elbows lightly against the front of your body.
5. To maintain a stable stance, place one foot slightly ahead of the other.
6. Press the camera against your face and look through the viewfinder.

 To shoot while looking at the LCD monitor, see pages 76 and 215.

Shutter Button

The shutter button has two steps. You can press the shutter button halfway. Then you can further press the shutter button completely.

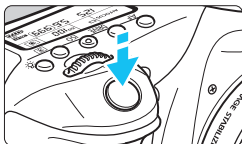

Pressing halfway

This activates autofocus and the automatic exposure system that sets the shutter speed and aperture.

The exposure setting (shutter speed and aperture) is displayed in the viewfinder and on the LCD panel (ⓘ4).

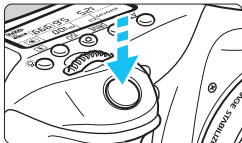

Pressing completely

This releases the shutter and takes the picture.

Preventing Camera Shake

Hand-held camera movement during the moment of exposure is called camera shake. It can cause blurred pictures. To prevent camera shake, note the following:

- Hold and steady the camera as shown on the preceding page.
- Press the shutter button halfway to autofocus, then slowly press the shutter button completely.



- In Creative Zone modes, pressing the <AF-ON> button is the same as pressing the shutter button halfway.
- If you press the shutter button completely without pressing it halfway first, or if you press the shutter button halfway and then press it completely immediately, the camera will take a moment before it takes the picture.
- Even during menu display, image playback, or image recording, you can instantly go back to shooting-ready by pressing the shutter button halfway.

Mode Dial

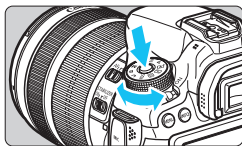



Turn the dial while holding down the lock release button at the center of the dial.

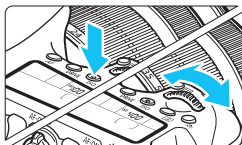

Main Dial





- (1) After pressing a button, turn the  dial.

When you press a button such as <AF> <DRIVE> <ISO> <>, the respective function remains selected for the duration of the timer (Ⓜ6). During this time, you can turn the  dial to set the desired setting.

When the function selection ends or if you press the shutter button halfway, the camera will be ready to shoot.

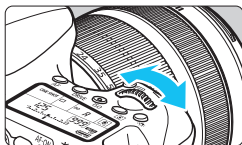
- Use this dial to select or set the AF operation, drive mode, ISO speed, metering mode, AF point selection, etc.



- (2) Turn the  dial only.

While looking at the viewfinder or LCD panel, turn the  dial to set the desired setting.

- Use this dial to set the shutter speed, aperture, etc.

 The operations in (1) are possible even while the <LOCK> switch is set upward (Multi function lock, p.48).

Quick Control Dial

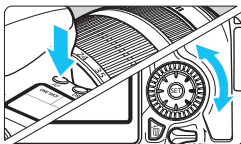

- (1) **After pressing a button, turn the <⦿> dial.**

When you press a button such as <AF> <DRIVE> <ISO> <☉>, the respective function remains selected for the duration of the timer (⌚). During this time, you can turn the <⦿> dial to set the desired setting.

When the function selection ends or if you press the shutter button halfway, the camera will be ready to shoot.

- Use this dial to select or set the AF operation, drive mode, ISO speed, metering mode, AF point selection, etc.

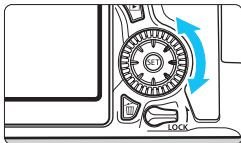

- (2) **Turn the <⦿> dial only.**

While looking at the viewfinder or LCD panel, turn the <⦿> dial to set the desired setting.

- Use this dial to set the exposure compensation amount, the aperture setting for manual exposures, etc.





The operations in (1) are possible even while the <LOCK> switch is set upward (Multi function lock, p.48).

Multi-controller

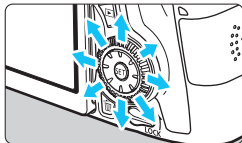
The Multi-controller <  > has eight keys that tilt in the directions shown by the arrows.



- Use the eight keys to select the AF point, correct the white balance, move the AF point or magnifying frame during Live View shooting, scroll around magnified images during playback, etc.
- For menus and the Quick Control, the Multi-controller works only in the vertical and horizontal directions <  > <  >. It does not work in diagonal directions.

LOCK Multi function Lock

With [ C.Fn III-2: Multi function lock] set (p.375) and the < **LOCK** > switch set upward, it prevents the Main Dial, Quick Control Dial, and Multi-controller from moving and changing a setting inadvertently.

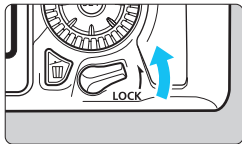

< **LOCK** > switch set downward:

Lock released



< **LOCK** > switch set upward:

Lock engaged

 If the < **LOCK** > switch is set upward and you try to use one of the locked camera controls, < **L** > will be displayed in the viewfinder and on the LCD panel. On the shooting function settings display (p.49), [**LOCK**] will be displayed.

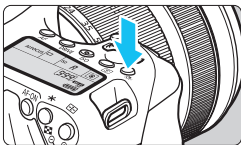
LCD Panel Illumination



Turn on () off the LCD panel illumination by pressing the < > button. During a bulb exposure, pressing the shutter button completely will turn off the LCD panel illumination.

Displaying Shooting Function Settings

After you press the <**INFO.**> button a number of times, the shooting function settings will be displayed.

With the shooting function settings displayed, you can turn the Mode Dial to see the settings for each shooting mode (p.395).

Pressing the <**Q**> button enables Quick Control of the shooting function settings (p.50).

Press the <**INFO.**> button again to turn off the display.

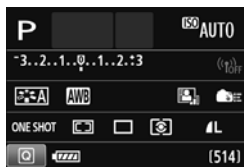

Q Quick Control for Shooting Functions

You can directly select and set the shooting functions displayed on the LCD monitor. This is called Quick Control.

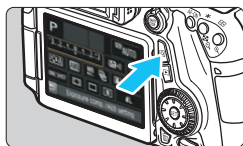

1 Press the <Q> button. (10)

- ▶ The Quick Control screen will appear.

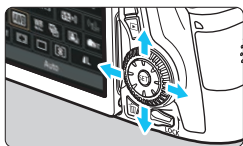

2 Set the desired functions.

- Press the <▲▼> <◀▶> keys to select a function.
- ▶ The setting of the selected function is displayed.
- Turn the <☀> or <⌚> dial to change the setting.

Basic Zone modes



Creative Zone modes

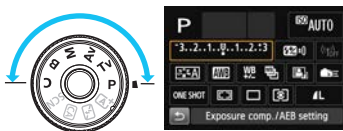

3 Take the picture.

- Press the shutter button completely to take the picture.
- ▶ The captured image will be displayed.

- For the functions settable in Basic Zone modes and the setting procedure, see page 91.
- In steps 1 and 2, you can also use the LCD monitor's touch screen (p.54).

Settable Functions on Quick Control Screen

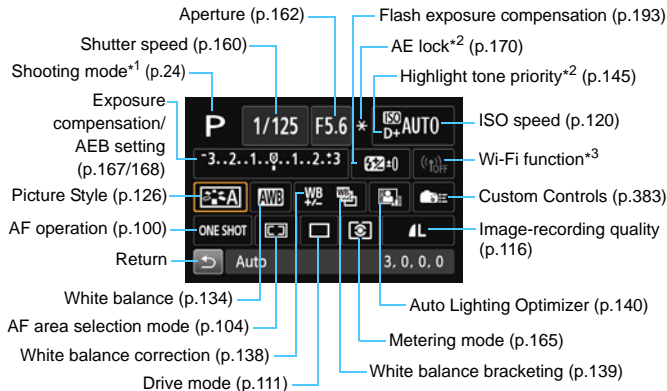

*1: This function cannot be set with the Quick Control screen when the Mode Dial is set to other than <SCN>.

*2: These functions cannot be set with the Quick Control screen.

*3: Refer to the Wi-Fi Function Instruction Manual.

Function Setting Screen



<SET>

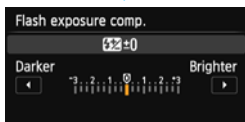

- Select the desired function and press <SET>. The function's setting screen will appear.
- Turn the <DIAL> or <DIAL> dial or press the <LEFT> or <RIGHT> key to change the settings. There are also some functions that are set by pressing the <INFO.>, <INFO.>, or <INFO.> button.
- Press <SET> to finalize the setting and return to the Quick Control screen.
- When you select <CUSTOM> (p.383) or <CUSTOM> (p.103) and press the <MENU> button, the shooting function settings display will reappear.

MENU Menu Operations

You can set various settings with the menus such as the image-recording quality, date/time, etc. While looking at the LCD monitor, use the <MENU> button, <▲> <▶> keys, and <SET> button on the camera back.

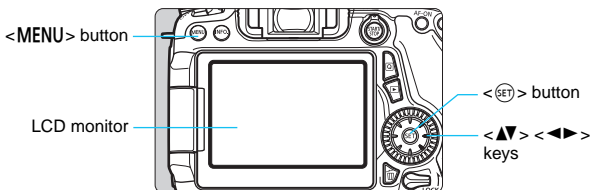

Menus in Basic Zone Modes

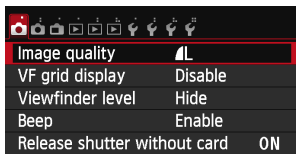
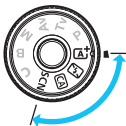

* Some menu tabs and menu items are not displayed in Basic Zone modes.

Menus in Creative Zone Modes

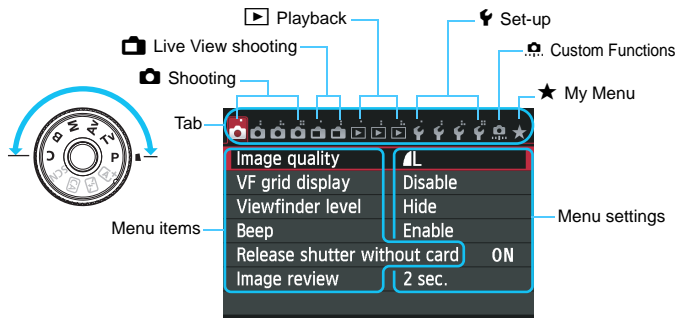

Menu Setting Procedure

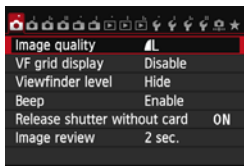

1 Display the menu screen.

- Press the <MENU> button to display the menu screen.

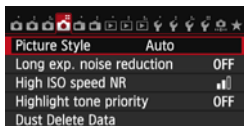

2 Select a tab.

- Press the <◀▶> key to select a menu tab.
- For example, in this manual, “the [📷4] tab” refers to the screen displayed when the fourth 📷 (Shooting) tab from the left [📷] is selected.



3 Select the desired item.

- Press the <▲▼> key to select the item, then press <SET>.

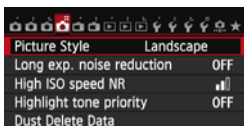

4 Select the setting.

- Press the <▲▼> <◀▶> keys to select the desired setting. (Some settings require you to press either the <▲▼> <◀▶> keys to select them.)
- The current setting is indicated in blue.

5 Adjust the setting.

- Press <SET> to finalize your changes.

6 Exit the setting.

- Press the <MENU> button to return to the shooting function settings display.



- In step 2, you can also turn the <🔘> dial to select a menu tab. In step 4, you can also turn the <🔘> dial to select certain settings.
- In steps 2 to 5, you can also use the LCD monitor's touch screen (p.54).
- The explanation of menu functions hereinafter assumes that you have pressed the <MENU> button to display the menu screen.
- To cancel the operation, press the <MENU> button.
- For details about each menu item, see page 408.

Using the Touch Screen

The LCD monitor is a touch-sensitive panel that you can operate with your fingers.

Tap

Quick Control (Sample display)



- Use your finger to tap (touch briefly and then remove your finger from) the LCD monitor.
- By tapping, you can select menus, icons, etc., displayed on the LCD monitor.
- When touch-screen operation is possible, a frame will appear around the icon (except on menu screens). For example, when you tap [Q], the Quick Control screen appears. By tapping [↶], you can return to the preceding screen.



Operations possible by tapping the screen

- Setting menu functions after pressing the <MENU> button
- Quick Control
- Setting functions after pressing the <AF>, <DRIVE>, <ISO>, <Q>, <AF-ON>, or <AE-L/AF-L> button
- Touch shutter during Live View shooting
- Setting functions during Live View shooting
- Setting functions during movie shooting
- Playback operations

Drag

Menu screen (Sample display)

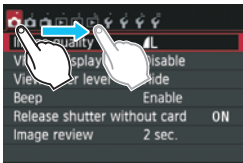

- Slide your finger while touching the LCD monitor.

Scale display (Sample display)



Operations possible by dragging your finger on the screen

- Selecting a menu tab or item after pressing the <MENU> button
- Setting a scale control
- Quick Control
- Setting functions during Live View shooting
- Setting functions during movie shooting
- Playback operations

MENU Silencing the Beep during Touch Operations

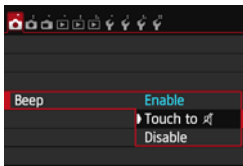

If [**1: Beep**] is set to [Touch to , the beep will not sound during touch operations.

MENU Touch Control Settings

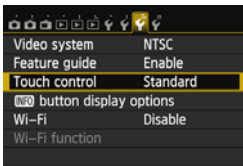

1 Select [Touch control].

- Under the [**3**] tab, select [**Touch control**], then press <[SET]>.

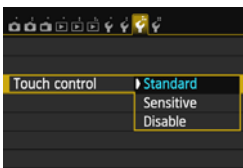

2 Set the touch control setting.

- Select the desired setting, then press <[SET]>.
- [**Standard**] is the normal setting.
- [**Sensitive**] provides a better touch response than [**Standard**]. Try using both settings and select the one you prefer.
- To disable touch-screen operations, select [**Disable**].

⚠ Cautions for Touch Screen Operations

- Since the LCD monitor is not pressure sensitive, do not use any sharp objects, such as your fingernail or a ballpoint pen, for touch operations.
- Do not use wet fingers for touch screen operations.
- If the LCD monitor has any moisture or if your fingers are wet, the touch screen may not respond or misoperation may occur. In such a case, turn off the power and wipe the LCD monitor with a cloth.
- Do not attach any protective sheet (commercially available) or sticker on the LCD monitor. It may make the touch operation response slow.
- If you quickly perform touch operation when [**Sensitive**] is set, the touch response may be slower.

Before You Start

MENU Formatting the Card

If the card is new or was previously formatted by another camera or computer, format the card with the camera.

- ❗ **When the card is formatted, all images and data on the card will be erased. Even protected images will be erased, so make sure there is nothing you need to keep. If necessary, transfer the images and data to a computer, etc., before formatting the card.**

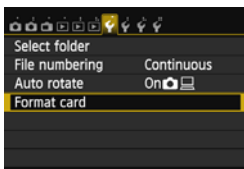

1 Select [Format card].

- Under the [**F1**] tab, select [**Format card**], then press <Ⓢ>.

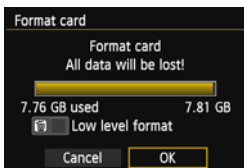

2 Format the card.

- Select [**OK**], then press <Ⓢ>.
- ▶ The card will be formatted.
- ▶ When the formatting is completed, the menu will reappear.

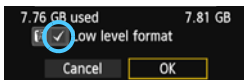

- For low-level formatting, press the <Ⓢ> button to append [**Low level format**] with a checkmark <✓>, then select [**OK**].



Format the card in the following cases:

- The card is new.
- The card was formatted by a different camera or a computer.
- The card is full with images or data.
- A card-related error is displayed (p.432).

Low-level Formatting

- Perform low-level formatting if the card's recording or reading speed seems slow or if you want to erase all data on the card.
- Since low-level formatting will format all recordable sectors on the card, the formatting will take slightly longer than normal formatting.
- You can stop the low-level formatting by selecting **[Cancel]**. Even in this case, normal formatting will be completed and you can use the card as usual.

- When the card is formatted or data is erased, only the file management information is changed. The actual data is not completely erased. Be aware of this when selling or discarding the card. When discarding the card, execute low-level formatting or destroy the card physically to prevent the personal data from being leaked.
- **Before using a new Eye-Fi card, the software on the card must be installed in your computer. Then format the card with the camera.**



- The card capacity displayed on the card format screen may be smaller than the capacity indicated on the card.
- This device incorporates exFAT technology licensed from Microsoft.

MENU Disabling the Beeper

You can prevent the beeper from sounding when focus is achieved, during self-timer operation, and during touch screen operations.

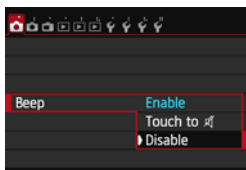

1 Select [Beep].

- Under the [**1**] tab, select [**Beep**], then press <SET>.

2 Select [Disable].

- Select [**Disable**], then press <SET>.
- The beeper will not sound for any operation.
- If [**Touch to**] is selected, the beeper will be silent for touch screen operations only.

MENU Setting the Power-off Time/Auto Power Off

To save battery power, the camera turns off automatically after a set time of idle operation elapses. If you do not want the camera to turn off automatically, set this to [**Disable**]. After the power turns off, you can turn on the camera again by pressing the shutter button or other buttons.



1 Select [Auto power off].

- Under the [**2**] tab, select [**Auto power off**], then press <SET>.

2 Set the desired time.

- Select the desired setting, then press <SET>.

Even if [**Disable**] is set, the LCD monitor will turn off automatically after 30 min. to save power. (The camera's power does not turn off.)

MENU Setting the Image Review Time

You can set how long the image is displayed on the LCD monitor immediately after capture. To keep the image displayed, set **[Hold]**. To not have the image displayed, set **[Off]**.

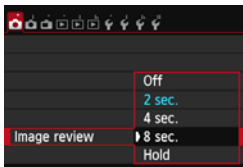

1 Select [Image review].

- Under the [**1**] tab, select **[Image review]**, then press **<SET>**.

2 Set the desired time.

- Select the desired setting, then press **<SET>**.

If **[Hold]** is set, the image will be displayed until the auto power off time elapses.

MENU Turning the LCD Monitor Off/On

The shooting function settings screen (p.49) can be set to display or turn off when you press the shutter button halfway.

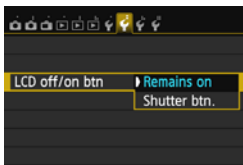

1 Select [LCD off/on btn].

- Under the [**2**] tab, select **[LCD off/on btn]**, then press **<SET>**.

2 Set the desired setting.

- Select the desired setting, then press **<SET>**.

- **[Remains on]:** Display remains on even when you press the shutter button halfway. To turn off the display, press the **<INFO.>** button.
- **[Shutter btn.]:** When you press the shutter button halfway, the display will turn off. When you let go of the shutter button, the display will turn on.

MENU Reverting the Camera to the Default Settings ☆

The camera's shooting function settings and menu settings can be reverted to their defaults.

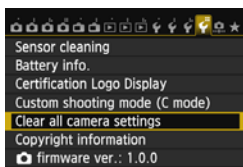

1 Select [Clear all camera settings].

- Under the [4] tab, select [Clear all camera settings], then press <SET>.



2 Select [OK].

- Select [OK], then press <SET>.
- Setting [Clear all camera settings] will reset the camera to the following default settings:

Shooting Function Settings

AF operation	One-Shot AF
AF area selection mode	Auto selection:19 pt AF
Metering mode	(Evaluative metering)
ISO speed	Auto
ISO speed range	Minimum limit: 100 Maximum limit: 12800
Auto ISO range	Minimum limit: 100 Maximum limit: 6400
Minimum shutter speed	Auto
Drive mode	(Single shooting)
Exposure compensation/AEB	Canceled
Flash exposure compensation	0 (Zero)

Red-eye reduction	Disable
Multiple exposure	Disable
HDR Mode	Disable HDR
Mirror lockup	Disable
VF grid display	Disable
Viewfinder level	Hide
Custom Functions	Unchanged
Flash control	
Flash firing	Enable
Flash sync. speed in Av mode	Auto

Image-recording Settings

Image quality	L
Picture Style	Auto
Auto Lighting Optimizer	Standard
Peripheral illumination correction	Enable/ Correction data retained
Chromatic aberration correction	Enable/ Correction data retained
White balance	(Auto)
Custom White Balance	Canceled
White balance correction	Canceled
White balance bracketing	Canceled
Color space	sRGB
Long exposure noise reduction	Disable
High ISO speed noise reduction	Standard
Highlight tone priority	Disable
File numbering	Continuous
Auto cleaning	Enable
Dust Delete Data	Erase

Camera Settings

Auto power off	1 min.
Beep	Enable
Release shutter without card	Enable
Image review	2 sec.
Highlight alert	Disable
AF point display	Disable
Playback grid	Off
Histogram display	Brightness
Movie playback count	Unchanged
Control over HDMI	Disable
Image jump w/	(10 images)
Auto rotate	On
LCD brightness	++++++
LCD off/on button	Remains on
Touch control	Standard
Date/Time/Zone	Unchanged
Language	Unchanged
Video system	Unchanged
Feature guide	Enable
button display options	All items selected
Custom shooting mode	Unchanged
Copyright information	Unchanged
Eye-Fi transmission	Disable
My Menu settings	Unchanged
Display from My Menu	Disable
Wi-Fi*	Disable

* The EOS 70D (N) does not have the Wi-Fi function (Not Displayed).

Refer to the Wi-Fi Function Instruction Manual for Wi-Fi function settings.

Live View Shooting Settings

Live View shooting	Enable
AF method	☺+Tracking
Continuous AF	Enable
Touch shutter	Disable
Grid display	Off
Aspect ratio	3:2
Exposure simulation	Enable
Silent LV shooting	Mode 1
Metering timer	16 sec.

Movie Shooting Settings

AF method	☺+Tracking
Movie Servo AF	Enable
Silent LV shooting	Mode 1
Metering timer	16 sec.
Grid display	Off
Movie recording size	1920x1080/IPB
Digital zoom	Disable
Sound recording	Auto
Time code	
Count up	Unchanged
Start time setting	Unchanged
Movie recording count	Unchanged
Movie playback count	Unchanged
Drop frame	Unchanged
Video snapshot	Disable

Displaying the Grid

You can display a grid in the viewfinder to help you straighten or compose the shot.

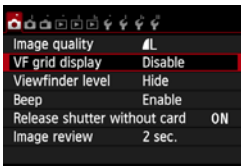

1 Select [VF grid display].

- Under the [📷1] tab, select [VF grid display], then press <SET>.

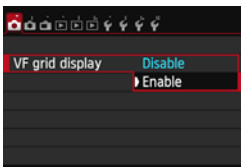

2 Select [Enable].

- Select [Enable], then press <SET>.

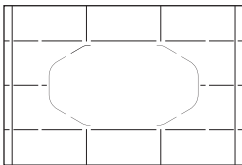

- ▶ When you exit the menu, the grid will appear in the viewfinder.

 A grid can also be displayed on the LCD monitor during Live View shooting and movie shooting (p.229, 276).

Displaying the Electronic Level

You can display the electronic level on the LCD monitor and in the viewfinder to help correct camera tilt. Note that you can check only the horizontal tilt and not the forward/backward tilt.

Displaying the Electronic Level on the LCD Monitor

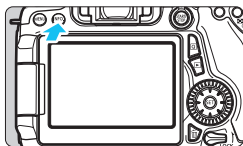

1 Press the <INFO.> button.

- Each time you press the <INFO.> button, the screen display will change.
- Display the electronic level.
- If the electronic level does not appear, set [ 3: **INFO** button display options] so that the electronic level can be displayed (p.394).

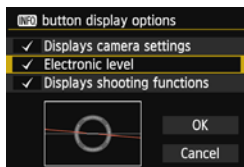

2 Check the camera's tilt.

- The horizontal tilt is displayed in 1° increments. The tilt scale is marked in 5° increments.
- When the red line turns green, it indicates that the tilt is almost corrected.



Horizontal level



- Even when the tilt is corrected, there may be a margin of error of $\pm 1^\circ$.
- If the camera is very tilted, the electronic level's margin of error will be larger.



During Live View shooting and before movie shooting (except with  + Tracking), you can also display the electronic level as described above (p.218, 258). Note that the electronic level cannot be displayed during movie shooting. (The electronic level will disappear when you start shooting a movie.)

MENU Displaying the Electronic Level in the Viewfinder During Shooting

A simple electronic level using a camera icon can be displayed in the viewfinder at the center bottom. Since this can be displayed while you shoot, you can correct any tilt during handheld shooting.

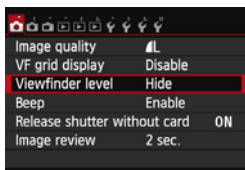

1 Select [Viewfinder level].

- Under the [📷1] tab, select [Viewfinder level], then press <SET>.



2 Select [Show].

- Select [Show], then press <SET>.

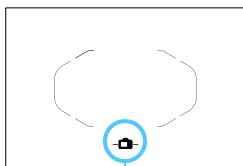

Electronic level

3 Press the shutter button halfway.

- The electronic level will appear as shown in the illustration.



- This also works with vertical shooting.

⚠️ Even when the tilt is corrected, there may be a margin of error of $\pm 1^\circ$.

MENU Displaying the Electronic Level in the Viewfinder Before Shooting[☆]

The viewfinder can display an electronic level and grid using the AF points. This is convenient to correct any camera tilt before shooting with a tripod.

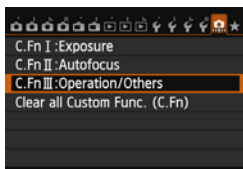

1 Select Custom Functions III.

- Under the [] tab, select [C.Fn III: Operation/Others], then press < [SET] >.

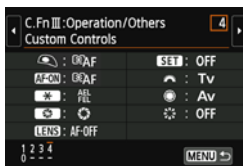

2 Select C.Fn III -4 [Custom Controls].

- Press the < [] > key to select [4: Custom Controls], then press < [SET] >.



3 Select [].

- Select []: DOF preview button], then press < [SET] >.

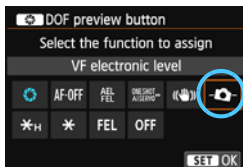

4 Select [- [] -].

- Select [- [] - : VF electronic level], then press < [SET] >.
- Press the < [MENU] > button to exit the menu.

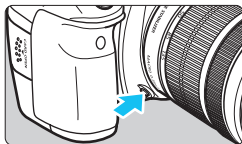

5 Display the electronic level.

- Press the Depth-of-field preview button.
- ▶ The viewfinder will display an electronic level and grid using the AF points.

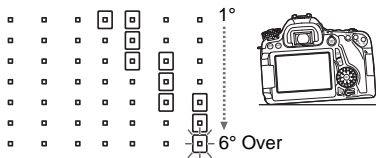
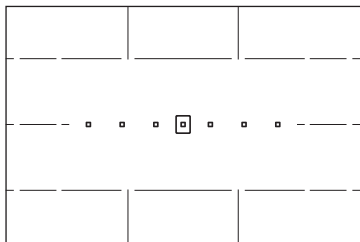

- Even when the tilt is corrected, there may be a margin of error of $\pm 1^\circ$.
- If the camera is very tilted, the electronic level's margin of error will be larger.
- If the Depth-of-field preview button has been assigned with **[VF electronic level]**, depth-of-field preview (p.163) will not work.

Feature Guide and Help

The Feature guide and Help display information about camera features.

Feature Guide

The Feature guide appears when you change the shooting mode or set a shooting function, Live View shooting, movie shooting, or Quick Control for playback, and displays a brief description of that mode, function or option. It also displays a description when you select a function or option on the Quick Control screen. When you proceed with the operation, the Feature guide will disappear.

● Shooting mode (Sample)



● Quick Control (Sample)

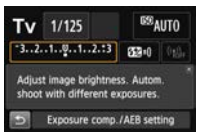

Shooting function settings



Live View shooting



Playback

MENU Disabling the Feature Guide

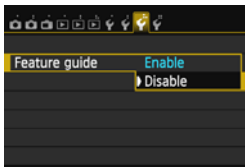

Select [Feature guide].

- Under the [**F3**] tab, select [**Feature guide**], then press <SET>.
- Select [**Disable**], then press <SET>.

? Help

When [**INFO Help**] is displayed at the bottom of the menu screen, pressing the <**INFO**> button displays the function's description (Help). If the Help fills more than one screen, a scroll bar will appear on the right edge. You can turn the <> dial or press the <**▲▼**> key to scroll.

- Example: [ 4: Long exp. noise reduction]

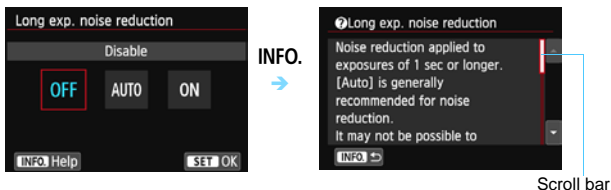

- Example: [ C.Fn I-1: Exposure level increments]



- Example: [ C.Fn II-1: Tracking sensitivity]



2

Basic Shooting

This chapter explains how to use the Basic Zone modes on the Mode Dial for best results.

With Basic Zone modes, all you do is point and shoot while the camera sets everything automatically (p.91, 404). Also, to prevent botched pictures due to mistaken operations, advanced shooting function settings cannot be changed.

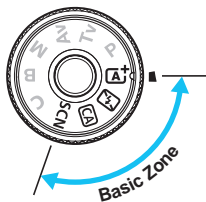

When you set the Mode Dial to <SCN> while the LCD monitor is turned off, press the <Q> button (p.81) or <INFO.> button (p.394) to check which shooting mode is set before shooting.

[A⁺] Fully Automatic Shooting (Scene Intelligent Auto) ■

<[A⁺]> is a fully automatic mode. The camera analyzes the scene and sets the optimum settings automatically. It also adjusts focus automatically by detecting whether the subject is still or moving (p.75).



1 Set the Mode Dial to <[A⁺]>.

- Turn the Mode Dial while holding down the lock release button at the center.

Area AF frame

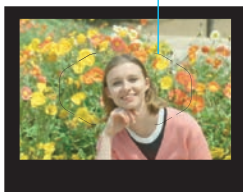

2 Aim the Area AF frame over the subject.

- All the AF points will be used to focus, and generally the closest object will be focused.
- Aiming the center of the Area AF frame over the subject will make focusing easier.

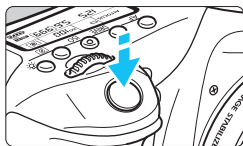

3 Focus the subject.

- Press the shutter button halfway. The lens focusing ring will rotate to focus.
- ▶ The AF point(s) that achieve(s) focus will be displayed. At the same time, the beeper will sound and the focus confirmation light <●> in the viewfinder will light up.
- ▶ In low light, the AF point(s) will light up briefly in red.
- ▶ If necessary, the built-in flash will be raised automatically.

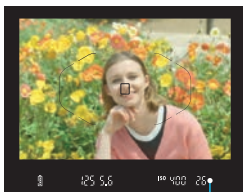

Focus confirmation light

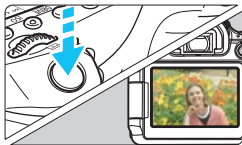

4 Take the picture.

- Press the shutter button completely to take the picture.
- ▶ The captured image will be displayed for 2 sec. on the LCD monitor.
- After you finish shooting, push down the built-in flash with your fingers.



The **<A+>** mode makes the colors look more impressive in nature, outdoor, and sunset scenes. If the desired color tone is not obtained, use a Creative Zone mode and select a Picture Style other than **<StA>** and shoot (p.126).

? FAQ

- **The focus confirmation light **<●>** blinks and focus is not achieved.**

Aim the Area AF frame over an area with good contrast, then press the shutter button halfway (p.45). If you are too close to the subject, move away and try again.

- **Multiple AF points light up simultaneously.**

Focus has been achieved at all those points. As long as the AF point covering the desired subject lights up, you can take the picture.

- **The beeper continues to beep softly. (The focus confirmation light **<●>** does not light up.)**



It indicates that the camera is focusing continuously on a moving subject. (The focus confirmation light **<●>** does not light up.) You can take sharp pictures of a moving subject.

Note that focus lock (p.75) will not work in this case.

- **Pressing the shutter button halfway does not focus the subject.**

If the focus mode switch on the lens is set to **<MF>** (manual focus), set it to **<AF>** (autofocus).

- **The flash fired even though it was daylight.**

For a backlit subject, the flash may fire to help lighten the subject's dark areas. If you do not want the flash to fire, use the Quick Control to set [**Flash firing**] to [] (p.90) or set the <> (Flash Off) mode and shoot (p.77).

- **The flash fired and the picture came out extremely bright.**

Move further from the subject and shoot. When shooting flash photography, if the subject is too close to the camera, the picture may come out extremely bright (overexposure).

- **In low light, the built-in flash fired a series of flashes.**

Pressing the shutter button halfway may trigger the built-in flash to fire a series of flashes to assist autofocusing. This is called the AF-assist beam. Its effective range is approx. 4 meters/13.1 feet.

- **When flash was used, the bottom part of the picture came out unnaturally dark.**



The shadow of the lens barrel was captured in the picture because the subject was too close to the camera. Move further from the subject and shoot. If a hood is attached to the lens, remove it before taking the flash picture.

Full Auto Techniques (Scene Intelligent Auto) ■

Recomposing the Shot



Depending on the scene, position the subject toward the left or right to create a balanced background and good perspective.

In the  mode, while you press the shutter button halfway to focus a still subject, the focus will be locked. You can then recompose the shot and press the shutter button completely to take the picture. This is called “focus lock”. Focus lock is also possible in other Basic Zone modes (except ).

Shooting a Moving Subject



In the  mode, if the subject moves (distance to camera changes) while or after you focus, AI Servo AF will take effect to focus the subject continuously. (The beeper will continue beeping softly.) As long as you keep aiming the Area AF frame on the subject while pressing the shutter button halfway, the focusing will be continuous. When you want to take the picture, press the shutter button completely.

Live View Shooting

You can shoot while viewing the image on the LCD monitor. This is called “Live View shooting”. For details, see page 215.

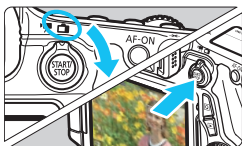

1 Set the Live View shooting/Movie shooting switch to .

2 Display the Live View image on the LCD monitor.

- Press the button.
- ▶ The Live View image will appear on the LCD monitor.



3 Focus the subject.

- Press the shutter button halfway to focus.
- ▶ When focus is achieved, the AF point will turn green and the beeper will sound.

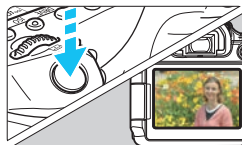

4 Take the picture.

- Press the shutter button completely.
- ▶ The picture will be taken and the captured image is displayed on the LCD monitor.
- ▶ After the image review ends, the camera will return to Live View shooting automatically.
- Press the button to end the Live View shooting.

You can also rotate the LCD monitor in different directions (p.34).



Normal angle



Low angle



High angle

Disabling Flash

<  > is a fully-automatic shooting mode that does not use flash. It is useful in museums, aquariums, and other places where flash is prohibited. This mode is also effective for capturing the particular ambience of a scene, such as candlelight scenes.

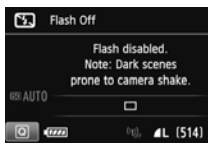
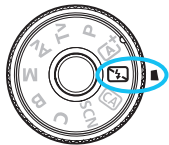

Shooting Tips

- **Prevent camera shake if the numeric display in the viewfinder blinks.**

Under low light when camera shake is prone to occur, the viewfinder's shutter speed display will blink. Hold the camera steady or use a tripod. When using a zoom lens, use the wide-angle end to reduce blur caused by camera shake even while handholding the camera.

- **Take portraits without flash.**

In low-light conditions, tell the subject to keep still until the picture is taken. Any movement by the subject during shooting may result in the subject being blurred in the picture.

CA Creative Auto Shooting

In the <CA> mode, you can easily blur the background and change the drive mode and flash firing. You can also choose the ambience you want to convey in your images. The default settings are the same as the <A+> mode.

* CA stands for Creative Auto.



1 Set the Mode Dial to <CA>.



2 Press the <Q> button. (10)
▶ The Quick Control screen will appear.

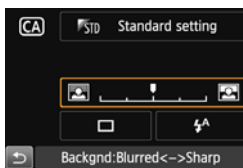

3 Set the desired function.

- Press the <▲> <◀> keys to select a function.
- ▶ The selected function and Feature guide (p.69) will appear.
- For the setting procedure and details on each function, see pages 79-80.

4 Take the picture.

- Press the shutter button completely to take the picture.

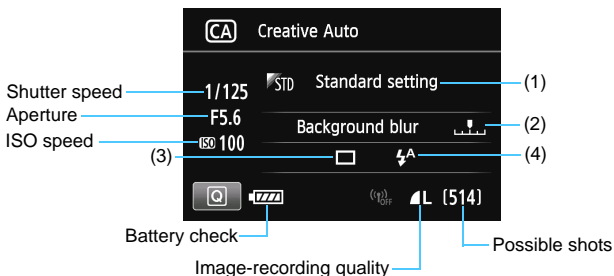

Pressing the **<Q>** button enables you to set the following:

(1) Ambience-based shots



You can choose the ambience you want to convey in your images. Turn the **<☀>** or **<🌙>** dial to select the desired ambience. You can also select it from a list by pressing **<SET>**. For details, see page 92.

(2) Blurring/sharpening the background



If you move the index mark toward the left, the background will look more blurred. If you move it toward the right, the background will look more in focus. Set it by pressing the **<◀▶>** key. You can also turn the **<☀>** or **<🌙>** dial to move the mark. If you want to blur the background, see “Shooting Portraits” on page 82.

Depending on the lens and shooting conditions, the background may not look so blurred. This function cannot be set (grayed out) while the built-in flash is raised in the **<⚡A>** or **<⚡>** mode. If flash is used, this setting will not be applied.

(3) Drive mode: Turn the  or  dial to select the desired drive mode. You can also select it from a list by pressing .

 **Single shooting:**

Shoot one image at a time.

 **High-speed continuous shooting:**

While you hold down the shutter button completely, shots will be taken continuously. You can shoot up to approx. 7.0 shots per second.

 **Low-speed continuous shooting:**

While you hold down the shutter button completely, shots will be taken continuously. You can shoot up to approx. 3.0 shots per second.

 **Silent single shooting:**

Single shooting with less shooting sound than .



 **Silent continuous shooting:**

Continuous shooting (max. approx. 3.0 shots per second) with less shooting sound than .

 **Self-timer: 10 sec./remote control:**

 **Self-timer: 2 sec./remote control:**

The picture is taken 10 seconds or 2 seconds after you press the shutter button. A remote controller can also be used.



(4) Flash firing: Turn the  or  dial to select the desired setting. You can also select it from a list by pressing .

 **Auto flash** : The flash fires automatically when necessary.

 **Flash on** : The flash fires at all times.

 **Flash off** : The flash is disabled.



- When using the self-timer, see the  notes on page 113.
- When using , see “Disabling Flash” on page 77.

SCN: Special Scene Mode

The camera will automatically choose the appropriate settings when you select a shooting mode for your subject or scene.



1 Set the Mode Dial to <SCN>.

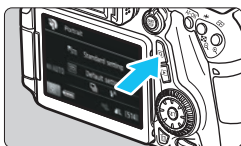

2 Press the <Q> button. (10)

- ▶ The Quick Control screen will appear.

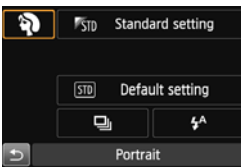

3 Select a shooting mode.

- Press the <▲▼> <◀▶> keys to select a shooting mode icon.
- Turn the <☀> or <⊙> dial to select a shooting mode.
- You can also select the shooting mode icon and press <SET> to display a list of shooting modes from which you can select one.

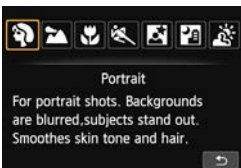

Available Shooting Modes in the <SCN> Mode

Shooting Mode	Page
Portrait	p.82
Landscape	p.83
Close-up	p.84
Sports	p.85

Shooting Mode	Page
Night Portrait	p.86
Handheld Night Scene	p.87
HDR Backlight Control	p.88

Shooting Portraits

The (Portrait) mode blurs the background to make the human subject stand out. It also makes skin tones and hair look softer.

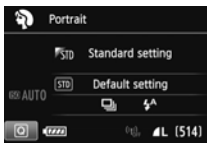
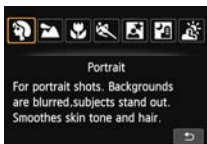

Shooting Tips

- **The further the distance between the subject and background, the better.**

The further the distance between the subject and background, the more blurred the background will look. The subject will also stand out better against an uncluttered dark background.

- **Use a telephoto lens.**

If you have a zoom lens, use the telephoto end to fill the frame with the subject from the waist up. Move in closer if necessary.

- **Focus the face.**

Check that the AF point covering the face flashes. For close-ups of the face, focus on the eyes.

 The default setting is (low-speed continuous shooting). If you hold down the shutter button, you can shoot continuously to capture subtle changes in the subject's pose and facial expression (max. approx. 3.0 shots/sec.).

Shooting Landscapes

Use the <> (Landscape) mode for wide scenery or to have everything in focus from near to far. For vivid blues and greens, and very sharp and crisp images.

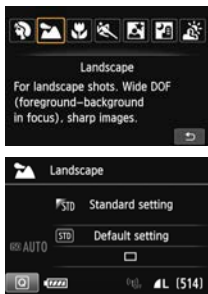

Shooting Tips

- **With a zoom lens, use the wide-angle end.**
When using the wide-angle end of a zoom lens, objects near and far will be in focus better than at the telephoto end. It also adds breadth to landscapes.
- **Shooting night scenes.**
The <> mode is also good for night scenes because it disables the built-in flash. When shooting night scenes, use a tripod to prevent camera shake.



- The built-in flash will not fire even in backlit or low-light conditions.
- If you are using an external Speedlite, the Speedlite will fire.

Shooting Close-ups

When you want to shoot flowers or small things up close, use the <> (Close-up) mode. To make small things appear much larger, use a macro lens (sold separately).





Shooting Tips

- **Use a simple background.**

A simple background makes small objects such as flowers stand out better.

- **Move as close as possible to the subject.**

Check the lens for its minimum focusing distance. Some lenses have indications such as <**MACRO 0.39m/1.3ft**> on them. The lens minimum focusing distance is measured from the <> (focal plane) mark on the top of the camera to the subject. If you are too close to the subject, the focus confirmation light <> will blink. If you use flash and the bottom of the picture looks unusually dark, move away from the subject.

- **With a zoom lens, use the telephoto end.**

If you have a zoom lens, using the telephoto end will make the subject look larger.

Shooting Moving Subjects

Use the < > (Sports) mode to shoot a moving subject, such as a running child or a moving vehicle.

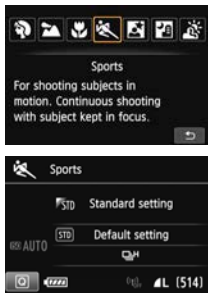

Shooting Tips

- **Use a telephoto lens.**

The use of a telephoto lens is recommended for shooting from a distance.

- **Track the subject with the Area AF frame.**

Aim the center AF point over the subject, then press the shutter button halfway to start autofocusing in Area AF frame. During autofocusing, the beeper will continue beeping softly. If focus cannot be achieved, the focus confirmation light <●> will blink. The default setting is < H> (high-speed continuous shooting). When you want to take the picture, press the shutter button completely. If you hold down the shutter button, you will be able to maintain autofocusing during continuous shooting of the subject's movement (max. approx. 7.0 shots per sec.).



- Under low light when camera shake is prone to occur, the viewfinder's shutter speed display on the bottom left will blink. Hold the camera steady and shoot.
- If you are using an external Speedlite, the Speedlite will fire.

Shooting Night Portraits (With a Tripod)

To shoot people at night and obtain a natural-looking night scene in the background, use the  (Night Portrait) mode. Using a tripod is recommended.

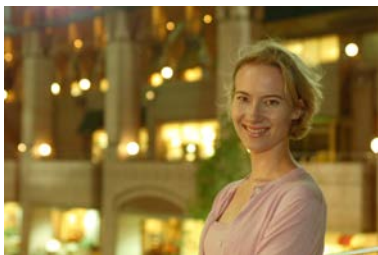
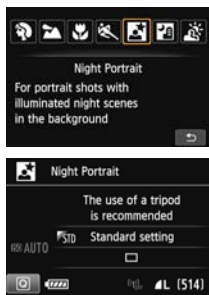

Shooting Tips

- **Use a wide-angle lens and a tripod.**



When using a zoom lens, use the wide-angle end to obtain a wide night view. Also, use a tripod to prevent camera shake.

- **Check the subject's brightness.**

Under low light, the built-in flash will fire automatically to obtain a good exposure of the subject.

It is recommended to play back the image after the shooting to check the image brightness. If the subject looks dark, move nearer and shoot again.

- **Also shoot in another shooting modes.**

Since camera shake is prone to occur with night shots, shooting also with  and  is recommended.

-  ● Tell the subject to keep still even after the flash fires.
- If you use the self-timer together with flash, the self-timer lamp will light up briefly after the picture is taken.
- See the cautions on page 89.

Shooting Night Scenes (Handheld)

Using a tripod for shooting a night scene yields the best results. However, with the  (Handheld Night Scene) mode, you can shoot night scenes while handholding the camera. In this mode, four shots are taken continuously for each picture, and a resulting bright image with reduced camera shake is recorded.

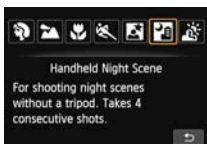



Shooting Tips

- **Hold the camera firmly.**

While shooting, hold the camera firmly and steadily. In this mode, four shots are aligned and merged into a single image. However, if there is significant misalignment in any of the four shots due to camera shake, they may not align properly in the final image.

- **For shots of people, turn on the flash.**

If you will include people in the picture, press the  button and set  (Flash on). To take a nice portrait, the first shot will use flash. Tell the subject not to move until all four continuous shots are taken.

 See the cautions on page 89.

Shooting Backlit Scenes

When shooting a scene having both bright and dark areas, use the  (HDR Backlight Control) mode. When you take one picture in this mode, three continuous shots are taken at different exposures. This results in one image, with a wide tonal range, that has minimized the blocked-up shadows caused by backlighting.

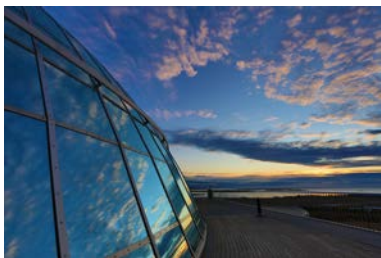
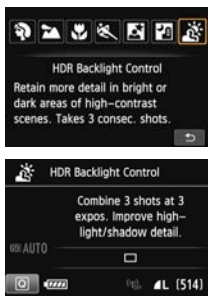

Shooting Tips

● Hold the camera firmly.

While shooting, hold the camera firmly and steadily. In this mode, three shots are aligned and merged into a single image. However, if there is significant misalignment in any of the three shots due to camera shake, they may not align properly in the final image.

-  Flash shooting is not possible. In low light, the AF-assist beam may be emitted (p.102).
- See the cautions on pages 89-90.

 HDR stands for High Dynamic Range.



Cautions for <M> Night Portrait and <P> Handheld Night Scene

- During Live View shooting, it may be difficult to focus dots of light such as in a night scene. In such a case, set the lens' focus mode switch to <MF> and focus manually.

Cautions for <P> Handheld Night Scene and <A> HDR Backlight Control

- Compared with other shooting modes, the shooting area will be smaller.
- You cannot select RAW or RAW+JPEG. If RAW is set, the image will be recorded in the **L** quality. Also, if RAW+JPEG is set, the image will be recorded in the set JPEG quality.
- If you shoot a moving subject, the subject's movement may leave afterimages or the surrounding area of the subject may become dark.
- The image alignment may not work properly with repetitive patterns (lattice, stripes, etc.), flat or single-tone images, or images significantly misaligned due to camera shake.
- Recording the image to the card will take longer than with normal shooting. During the processing of the images, "buSY" will be displayed in the viewfinder and on the LCD panel and you cannot take another picture until the processing is completed.
- If the shooting mode is set to <P> or <A>, direct printing (p.346) is not possible.

Cautions for <M> Night Portrait

- During Live View shooting, it may be difficult to focus when the face of the subject looks dark. In such a case, set the lens' focus mode switch to <MF> and focus manually.

Cautions for <P> Handheld Night Scene

- When shooting flash photography, if the subject is too close to the camera, the picture may come out extremely bright (overexposure).
- If you use flash to shoot a night scene with few lights, the shots may not align correctly. This can result in a blurry photo.
- If you use flash and the human subject is close to the background that is also illuminated by the flash, the shots may not align correctly. This can result in a blurry photo. Unnatural shadows and unsuitable colors may also appear.
- External Speedlite flash coverage
 - When using a Speedlite with automatic flash coverage setting, the zoom position will be fixed to the wide end, regardless of the lens' zoom position.
 - When using a Speedlite requiring manual flash coverage setting, set the flash head to the wide (normal) position.

Cautions for HDR Backlight Control

- Note that the image may not be rendered with a smooth gradation and may look irregular or have significant noise.
- HDR Backlight Control may not be effective for excessively backlit scenes or extremely high-contrast scenes.

Quick Control

In Basic Zone modes when the shooting function settings screen is displayed, you can press the  button to display the Quick Control screen. The table on the next page shows the functions that can be set with the Quick Control screen in each Basic Zone mode.

1 Set the Mode Dial to a Basic Zone mode.



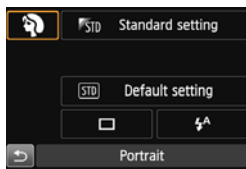

2 Press the button. (10)

- ▶ The Quick Control screen will appear.



Example: Portrait mode

3 Set the desired functions.

- Press the   keys to select a function.
- ▶ The selected function and Feature guide (p.69) will appear.
- Functions can also be selected with the  or  dial.

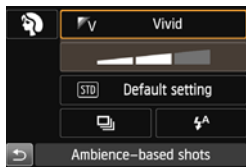

Settable Functions in Basic Zone Modes

●: Default setting ○: User selectable □: Not selectable

Function				CA	SCN	
Drive mode	: Single shooting	●	●	●	○	●
	H: High-speed continuous shooting	○	○	○	○	○
	: Low-speed continuous shooting	○	○	○	●	○
	S: Silent single shooting	○	○	○	○	○
	S: Silent continuous shooting	○	○	○	○	○
	Self-timer (p.113)		○	○	○	○
		○	○	○	○	○
Flash firing	A: Automatic firing	●		●	●	
	: Flash on (Fires at all times)	○		○	○	
	: Flash off	○	●	○	○	●
Ambience-based shots (p.92)				○	○	○
Light/scene-based shots (p.96)					○	○
Blurring/sharpening the background (p.79)				○		

Function		SCN				
Drive mode	: Single shooting	●	○	●	●	●
	H: High-speed continuous shooting	○	●	○	○	○
	: Low-speed continuous shooting	○	○	○	○	○
	S: Silent single shooting	○	○	○	○	○
	S: Silent continuous shooting	○	○	○	○	○
	Self-timer (p.113)		○	○	○	○
		○	○	○	○	○
Flash firing	A: Automatic firing	●		●		
	: Flash on (Fires at all times)	○			○	
	: Flash off	○	●		●	●
Ambience-based shots (p.92)		○	○	○	○	
Light/scene-based shots (p.96)		○	○			
Blurring/sharpening the background (p.79)						

* If you change the shooting mode or set the power switch to <OFF>, it will revert to the default settings (except the self-timer).

Shoot by Ambience Selection

Except in the $\langle \text{CA}^+ \rangle$, $\langle \text{CA}^- \rangle$, and $\langle \text{SCN}^+ \rangle$ Basic Zone modes, you can select the ambience for shooting.

Ambience	CA	SCN						Ambience Effect
STD Standard setting	<input type="radio"/>	<input type="radio"/>	<input type="radio"/>	<input type="radio"/>	<input type="radio"/>	<input type="radio"/>	<input type="radio"/>	No setting
V Vivid	<input type="radio"/>	<input type="radio"/>	<input type="radio"/>	<input type="radio"/>	<input type="radio"/>	<input type="radio"/>	<input type="radio"/>	Low / Standard / Strong
S Soft	<input type="radio"/>	<input type="radio"/>	<input type="radio"/>	<input type="radio"/>	<input type="radio"/>	<input type="radio"/>	<input type="radio"/>	Low / Standard / Strong
W Warm	<input type="radio"/>	<input type="radio"/>	<input type="radio"/>	<input type="radio"/>	<input type="radio"/>	<input type="radio"/>	<input type="radio"/>	Low / Standard / Strong
I Intense	<input type="radio"/>	<input type="radio"/>	<input type="radio"/>	<input type="radio"/>	<input type="radio"/>	<input type="radio"/>	<input type="radio"/>	Low / Standard / Strong
C Cool	<input type="radio"/>	<input type="radio"/>	<input type="radio"/>	<input type="radio"/>	<input type="radio"/>	<input type="radio"/>	<input type="radio"/>	Low / Standard / Strong
B Brighter	<input type="radio"/>	<input type="radio"/>	<input type="radio"/>	<input type="radio"/>	<input type="radio"/>	<input type="radio"/>	<input type="radio"/>	Low / Medium / High
D Darker	<input type="radio"/>	<input type="radio"/>	<input type="radio"/>	<input type="radio"/>	<input type="radio"/>	<input type="radio"/>	<input type="radio"/>	Low / Medium / High
M Monochrome	<input type="radio"/>	<input type="radio"/>	<input type="radio"/>	<input type="radio"/>	<input type="radio"/>	<input type="radio"/>	<input type="radio"/>	Blue / B/W / Sepia

1 Set the shooting mode to $\langle \text{CA} \rangle$ or $\langle \text{SCN} \rangle$.

- If the shooting mode is $\langle \text{SCN} \rangle$, set one of the following: $\langle \text{Person icon} \rangle$, $\langle \text{Landscape icon} \rangle$, $\langle \text{Flower icon} \rangle$, $\langle \text{Bird icon} \rangle$, $\langle \text{Sunset icon} \rangle$, or $\langle \text{Portrait icon} \rangle$.

2 Set the Live View shooting/Movie shooting switch to $\langle \text{Camera icon} \rangle$.

3 Display the Live View image.

- Press the $\langle \text{START/STOP} \rangle$ button to display the Live View image.



4 On the Quick Control screen, select the desired ambience.

- Press the $\langle \text{Q} \rangle$ button (10).
- Press the $\langle \blacktriangle \rangle$ key to select [STD Standard setting]. [Ambience-based shots] will appear on the screen.
- Press the $\langle \blacktriangleleft \blacktriangleright \rangle$ key to select the desired ambience.



- ▶ The LCD monitor will display how the image will look with the selected ambience.



5 Set the ambience effect.

- Press the <▲▼> key to select the effect bar so that [Effect] appears at the bottom.
- Press the <◀▶> key to select the desired effect.

6 Take the picture.

- Press the shutter button completely to take the picture.
- To return to viewfinder shooting, press the <START/STOP> button to exit Live View shooting. Then press the shutter button completely to take the picture.
- If you change the shooting mode or set the power switch to <OFF>, the setting will revert back to [STD Standard setting].



- The Live View image shown with the ambience setting applied will not look exactly the same as the actual photo.
- Using flash may minimize the ambience effect.
- In bright outdoors, the Live View image you see on the LCD monitor may not have exactly the same brightness or ambience as the actual photo. Set [Y2: LCD brightness] to 4 and look at the Live View image while the LCD monitor is unaffected by outside light.





If you do not want the Live View image to be displayed while setting functions, press the <Q> button after step 1 and set [Ambience-based shots] and [Effect].

Ambience Settings

Standard setting

Standard image characteristics for the respective shooting mode.

Note that <  > has image characteristics geared for portraits and <  > is geared for landscapes. Each ambience is a modification of the respective shooting mode's image characteristics.

Vivid

The subject will look sharp and vivid. It makes the photo look more impressive than with  **Standard setting**].

Soft

The subject will look softer and more dainty. Good for portraits, pets, flowers, etc.

Warm

The subject will look softer with warmer colors. Good for portraits, pets, and other subjects to which you want to give a warm look.

Intense

While the overall brightness is slightly lowered, the subject is emphasized for a more intense feeling. Makes the human or living subject stand out more.

Cool

The overall brightness is slightly lowered with a cooler color cast. A subject in the shade will look more calm and impressive.

B **Brighter**

The picture will look brighter.

D **Darker**

The picture will look darker.

M **Monochrome**

The picture will be monochrome. You can select the monochrome color to be black and white, sepia, or blue. When **[Monochrome]** is selected, <Ⓜ> will appear in the viewfinder.

Shoot by Lighting or Scene Type

In the <☺>, <☷>, <☸>, and <☹> Basic Zone modes, you can shoot while the settings match the lighting or scene type. Normally, [STD] **Default setting** is adequate, but if the settings match the lighting condition or scene, the picture will look more accurate to your eye. For Live View shooting, if you set both [**Light/scene-based shots**] and [**Ambience-based shots**] (p.92), you should first set [**Light/scene-based shots**]. This will make it easier to see the resulting effect on the LCD monitor.

Lighting or scene	SCN			
	☺	☷	☸	☹
[STD] Default setting	<input type="radio"/>	<input type="radio"/>	<input type="radio"/>	<input type="radio"/>
[☼] Daylight	<input type="radio"/>	<input type="radio"/>	<input type="radio"/>	<input type="radio"/>
[☒] Shade	<input type="radio"/>	<input type="radio"/>	<input type="radio"/>	<input type="radio"/>
[☁] Cloudy	<input type="radio"/>	<input type="radio"/>	<input type="radio"/>	<input type="radio"/>
[☀] Tungsten light	<input type="radio"/>	<input checked="" type="radio"/>	<input type="radio"/>	<input type="radio"/>
[💡] Fluorescent light	<input type="radio"/>	<input checked="" type="radio"/>	<input type="radio"/>	<input type="radio"/>
[🌅] Sunset	<input type="radio"/>	<input type="radio"/>	<input type="radio"/>	<input type="radio"/>

- 1 Set the shooting mode to <SCN>.**
 - Set one of the following: <☺>, <☷>, <☸>, or <☹>.
- 2 Set the Live View shooting/Movie shooting switch to <📷>.**
- 3 Display the Live View image.**
 - Press the <START/STOP> button to display the Live View image.





4 On the Quick Control screen, select the lighting or scene type.

- Press the <Q> button (10).
- Press the <▲▼> key to select [STD **Default setting**]. [Light/scene-based shots] will appear on the screen.
- Press the <◀▶> key to select the desired lighting or scene type.
- ▶ The resulting image with the selected lighting or scene type will be displayed.

5 Take the picture.

- Press the shutter button completely to take the picture.
- To return to viewfinder shooting, press the <START/STOP> button to exit Live View shooting. Then press the shutter button completely to take the picture.
- If you change the shooting mode or set the power switch to <OFF>, the setting will revert back to [STD **Default setting**].



- If you use flash, the setting will switch to [STD **Default setting**]. (However, the shooting information will display the lighting or scene type that was set.)
- If you want to set this together with [Ambience-based shots], set the lighting or scene type that best matches the ambience you have set. In the case of [Sunset], for example, warm colors will become prominent so the ambience you set may not work well.



If you do not want the Live View image to be displayed when setting functions, press the <Q> button after step 1 and set [Light/scene-based shots].

Lighting or Scene Type Settings

Default setting

Default setting suited for most subjects.

Daylight

For subjects under sunlight. Gives more natural-looking blue skies and greenery and reproduces light-colored flowers better.

Shade

For subjects in the shade. Suitable for skin tones, which may look too bluish, and for light-colored flowers.

Cloudy

For subjects under overcast skies. Makes skin tones and landscapes, which may otherwise look dull on a cloudy day, look warmer. Also effective for light-colored flowers.

Tungsten light

For subjects lit under tungsten lighting. Reduces the reddish-orange color cast caused by tungsten lighting.

Fluorescent light

For subjects under fluorescent lighting. Suited for all types of fluorescent lighting.

Sunset

Suitable when you want to capture the sunset's impressive colors.

3

Setting the AF and Drive Modes

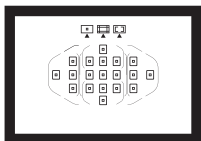

The 19 AF points in the viewfinder make AF shooting suitable for a wide variety of subjects and scenes.

You can also select the AF operation and drive mode that best match the shooting conditions and subject.

- The ☆ icon at the upper right of the page title indicates that the function is available only in Creative Zone modes (**P/Tv/Av/M/B**).
- In Basic Zone modes, the AF operation and AF point (AF area selection mode) are set automatically.



<AF> stands for autofocus. **<MF>** stands for manual focus.

AF: Selecting the AF Operation ☆

You can select the AF operation characteristics to suit the shooting conditions or subject. In Basic Zone modes, the optimum AF operation is set automatically for the respective shooting mode.

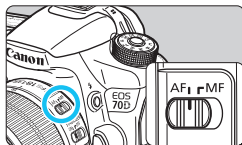

1 Set the lens focus mode switch to <AF>.

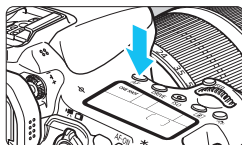

2 Turn the Mode Dial to a Creative Zone mode.

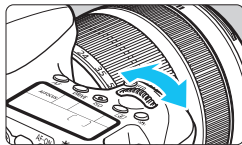

3 Press the <AF> button. (ⓘ6)

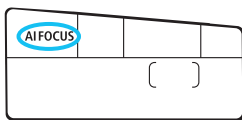

4 Select the AF operation.

- While looking at the LCD panel, turn the <☀> or <☾> dial.

ONE SHOT : One-Shot AF

AI FOCUS : AI Focus AF

AI SERVO : AI Servo AF

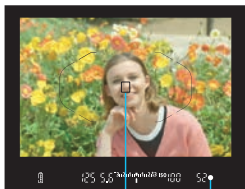

 In Creative Zone modes, you can also press the <AF-ON> button to autofocus.

One-Shot AF for Still Subjects



AF point
Focus confirmation light

Suited for still subjects. When you press the shutter button halfway, the camera will focus only once.

- When focus is achieved, the AF point that achieved focus will be displayed, and the focus confirmation light <●> in the viewfinder will also light up.
 - With evaluative metering, the exposure setting will be set at the same time focus is achieved.
- While you hold down the shutter button halfway, the focus will be locked. You can then recompose the shot if desired.
-  ● If focus cannot be achieved, the focus confirmation light <●> in the viewfinder will blink. If this occurs, the picture cannot be taken even if the shutter button is pressed completely. Recompose the shot and try to focus again, or see “When Autofocus Fails” (p.109).
- If [ 1: Beep] is set to [Disable], the beeper will not sound when focus is achieved.
 - After achieving focus with One-Shot AF, you can lock the focus on a subject and recompose the shot. This is called “focus lock”. This is convenient when you want to focus on a subject not covered by the Area AF frame.

AI Servo AF for Moving Subjects

This AF operation is suited for moving subjects when the focusing distance keeps changing. While you hold down the shutter button halfway, the subject will be focused continuously.

- The exposure is set at the moment the picture is taken.
- When the AF area selection mode is set to 19-point automatic selection AF (p.103), the camera first uses the manually-selected AF point to focus. During autofocusing, if the subject moves away from the manually-selected AF point, focus tracking continues as long as the subject is covered by the Area AF frame.

 With AI Servo AF, the beeper will not sound even when focus is achieved. Also, the focus confirmation light <●> in the viewfinder will not light up.

AI Focus AF for Switching the AF Operation Automatically

AI Focus AF switches the AF operation from One-Shot AF to AI Servo AF automatically if a still subject starts moving.

- After the subject is focused in One-Shot AF, if the subject starts moving, the camera will detect the movement, change the AF operation automatically to AI Servo AF, and keep tracking the moving subject.

 When focus is achieved with AI Focus AF with the Servo operation active, the beeper will continue beeping softly. However, the focus confirmation light <●> in the viewfinder will not light up. Note that focus will not be locked in this case.

AF-Assist Beam with the Built-in Flash

Under low-light conditions, when you press the shutter button halfway, the built-in flash may fire a brief burst of flashes. It illuminates the subject to enable easier autofocusing.

-  AF-assist beam will not be emitted by the built-in flash in <Tv>, <Av>, or <M> mode, or when [Flash firing] is set to <⊕> in <A+>, <CA>, <P>, <M>, or <P> mode.
- The AF-assist beam cannot be emitted with AI Servo AF operation.

-  The effective range of the AF-assist beam emitted by the built-in flash is approx. 4 meters/13.1 feet.
- In Creative Zone modes, when you raise the built-in flash with the <⚡> button, the AF-assist beam will fire when necessary.

Selecting the AF Area ☆

19 AF points are provided for AF. You can select the AF point(s) suiting the scene or subject.

AF Area Selection Mode

You can select one of three AF area selection modes. See the next page for the selection procedure.

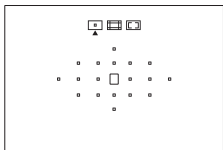

Single-point AF (Manual selection)

Select one AF point to focus.

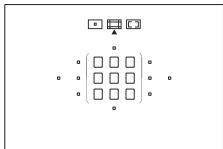

Zone AF (Manual zone selection)

The 19 AF points are divided into five zones for focusing.

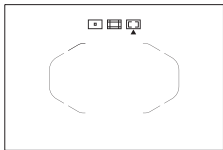

19-point automatic selection AF

All the AF points are used to focus. **This mode is set automatically in Basic Zone modes.**

Selecting the AF Area Selection Mode

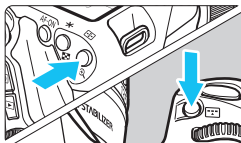

1 Press the <☰> or <☰> button. (⌚6)

- Look through the viewfinder and press the <☰> or <☰> button.

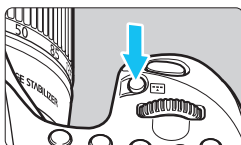

2 Press the <☰> button.

- Each time you press the <☰> button, the AF area selection mode changes.
- The AF area selection mode currently set is indicated on the top of the viewfinder.

AF area selection mode

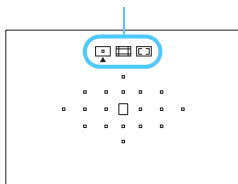

- ☐: **Single-point AF**
(Manual selection)
- ☐: **Zone AF**
(Manual zone selection)
- ☐: **19-point automatic selection AF**

- With [**C.Fn II-7: Select AF area selec. mode**], you can limit the selectable AF area selection modes (p.372).
- If you set [**C.Fn II-8: AF area selection method**] to [**☰ → Main Dial**], you can select the AF area selection mode by pressing the <☰> or <☰> button, then turning the <☰> dial (p.372).

Selecting the AF Point Manually

You can manually select the AF point or zone. If 19-point automatic selection AF + AI Servo AF has been set, you can select any position where AI Servo AF is to start.

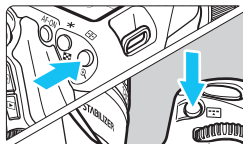

1 Press the or button. (⊙6)

- ▶ The AF points will be displayed in the viewfinder.
- In the Zone AF mode, the selected zone will be displayed.

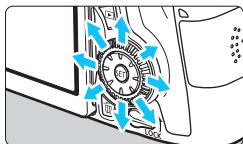

2 Select an AF point.

- The AF point selection will change in the direction you tilt . If you press , the center AF point (or center zone) will be selected.
- You can also select a horizontal AF point by turning the dial and select a vertical AF point by turning the dial.
- In the Zone AF mode, turning the or dial will change the zone in a looping sequence.

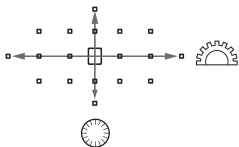

- When you hold down the button and turn the dial, you can select a vertical AF point.
- When you press the or button, the LCD panel displays the following:
 - 19-point automatic selection AF and Zone AF (manual zone selection): AF
 - 1 pt AF (Manual selection): SEL [] (Center)/SEL AF (Off center)
- With C.Fn II-10: Manual AF pt. selec. pattern], you can set either [Stops at AF area edges] or [Continuous] (p.373).

AF Area Selection Modes

Single-point AF (Manual Selection)



Select one AF point <□> to be used for focusing.

Zone AF (Manual Zone Selection)

The 19 AF points are divided into five zones for focusing. All the AF points in the selected zone are used for the automatic selection of the point of focus. It makes achieving focus easier than with single-point AF and it is effective for moving subjects.

However, since it is inclined to focus the nearest subject, focusing a specific target is harder than with single-point AF.

The AF point(s) achieving focus is displayed as <□>.

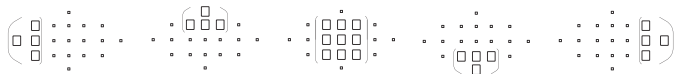

19-point Automatic Selection AF

All the AF points are used to focus. This mode is set automatically in Basic Zone modes.



With One-Shot AF, pressing the shutter button halfway will display the AF point(s) <□> that achieved focus. If multiple AF points are displayed, it means they all have achieved focus. This mode tends to focus the nearest subject.



With AI Servo AF, the manually-selected (p.105) AF point <□> is used first to achieve focus. The AF point(s) achieving focus is displayed as <□>.



- When AI Servo AF mode is set with 19-point automatic selection AF or Zone AF, the active AF point <□> will keep switching to track the subject. However, under certain shooting conditions (such as when the subject is small), it may not be able to track the subject. Also, in low temperatures, the tracking response is slower.
- If the camera cannot focus with the EOS-dedicated external Speedlite's AF-assist beam, set the AF area selection mode to Single-point AF (manual selection) and select the center AF point to autofocus.
- When the AF point(s) light up, part or all of the viewfinder may light up in red. This is a characteristic of AF point display (using liquid crystal).



If you set [**C.Fn II-9 : Orientation linked AF point**] to [**1: Select separate AF points**], you can set the AF area selection mode and manually-selected AF point (or zone) separately for vertical and horizontal shooting (p.373).

AF Operation and Maximum Lens Apertures

Maximum Lens Aperture: f/3.2 - f/5.6

With all AF points, cross-type AF sensitive to both vertical and horizontal lines is possible. However, with the lenses below, the peripheral AF points will detect only vertical or horizontal lines (no cross-type focusing).

Lenses that Do Not Support Cross-Type Focusing with Peripheral AF Points

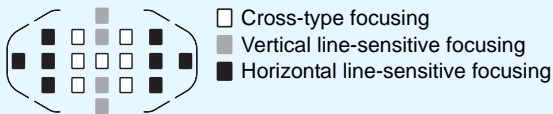

Cross-type focusing at the and AF points is not possible with the following lenses:

EF35-80mm f/4-5.6, EF35-80mm f/4-5.6 II, EF35-80mm f/4-5.6 III,
 EF35-80mm f/4-5.6 USM, EF35-105mm f/4.5-5.6, EF35-105mm f/4.5-5.6
 USM, EF80-200mm f/4.5-5.6 II, EF80-200mm f/4.5-5.6 USM

Maximum Lens Aperture: f/1.0 - f/2.8

Besides cross-type focusing (vertical and horizontal lines detected simultaneously), the center AF point can also perform high-precision, vertical-line sensitive AF.*

The remaining 18 AF points perform cross-type focusing, as with when maximum lens aperture is f/3.2 - f/5.6.

* Except with the EF28-80mm f/2.8-4L USM and EF50mm f/2.5 Compact Macro.

When Autofocus Fails

Autofocus can fail to achieve focus (viewfinder's focus confirmation light <●> blinks) with certain subjects such as the following:

Subjects Difficult to Focus

- Very low-contrast subjects
(Example: Blue sky, solid-color walls, etc.)
- Subjects in very low light
- Extremely backlit and reflective subjects
(Example: Car with a highly reflective body, etc.)
- Near and far subjects covered by an AF point
(Example: Animal in a cage, etc.)
- Repetitive patterns
(Example: Skyscraper windows, computer keyboards, etc.)

In such cases, do either of the following:

- (1) With One-Shot AF, focus an object at the same distance as the subject and lock the focus before recomposing the shot (p.75).
- (2) Set the lens focus mode switch to <MF> and focus manually (p.110).



For subjects difficult to focus during Live View shooting or movie shooting with [**AF-ON**+Tracking], [**FlexiZone - Multi**], or [**FlexiZone - Single**], see page 241.

MF: Manual Focus

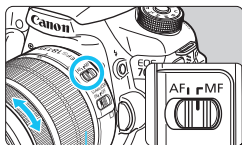

Focusing ring

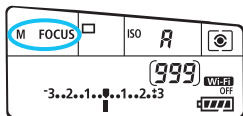

1 Set the lens focus mode switch to <MF>.

▶ <M FOCUS> will be displayed on the LCD panel.

2 Focus the subject.

- Focus by turning the lens focusing ring until the subject looks sharp in the viewfinder.

 If you press the shutter button halfway during manual focusing, the AF point that achieved focus and the focus confirmation light <●> will light up in the viewfinder.

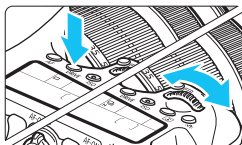

Selecting the Drive Mode

Single and continuous drive modes are provided.



1 Press the <DRIVE> button. (ⓘ6)

2 Select the drive mode.

- While looking at the LCD panel, turn the < > or < > dial.

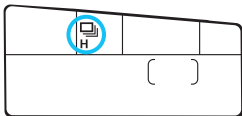

: **Single shooting**

When you press the shutter button completely, only one shot will be taken.

H : **High-speed continuous shooting** (Max. approx. 7.0 shots/sec.)

: **Low-speed continuous shooting** (Max. approx. 3.0 shots/sec.)

While you hold down the shutter button completely, shots will be taken continuously.

S : **Silent single shooting**

Single shooting with less shooting sound than < >.



S : **Silent continuous shooting** (Max. approx. 3.0 shots/sec.)

Continuous shooting with less shooting sound than < >.

: **10-sec. self-timer/remote control**

2 : **2-sec. self-timer/remote control**

For self-timer shooting, see page 113. For remote control shooting, see page 184.

- If  or  is set, the time lag from when you press the shutter button completely until the picture is shot will be slightly longer than with normal single or continuous shooting.
- When the battery level is low, the continuous shooting speed may become slightly slower.
- In AI Servo AF operation, the continuous shooting speed may become slightly slower depending on the subject and the lens used.
- H: The maximum continuous shooting speed of approx. 7 shots/sec. is attained under the following conditions*: At 1/500 sec. or faster shutter speed, and at the maximum aperture (varies depending on the lens). The continuous shooting speed may decrease due to shutter speed, aperture, subject conditions, brightness, lens, flash use, temperature, battery remaining capacity, etc.
 - * With the AF mode set to One-Shot AF and the Image Stabilizer turned off when using the following lenses: EF300mm f/4L IS USM, EF28-135mm f/3.5-5.6 IS USM, EF75-300mm f/4-5.6 IS USM, EF100-400mm f/4.5-5.6L IS USM.
- When using Battery Grip BG-E14 (sold separately) and size-AA/LR6 batteries, high-speed continuous shooting speed will be slower.

🕒 Using the Self-timer

Use the self-timer when you want to be in the picture.



1 Press the <DRIVE> button. (🕒6)

2 Select the self-timer.

- While looking at the LCD panel, turn the <🕒> or <🕒> dial to select the self-timer delay.

🕒🕒 : 10-sec. self-timer

🕒2 : 2-sec. self-timer

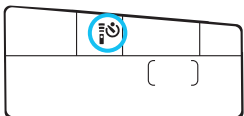

3 Take the picture.

- Look through the viewfinder, focus the subject, then press the shutter button completely.
- ▶ You can check the self-timer operation with the self-timer lamp, beeper, and countdown display (in seconds) on the LCD panel.
- ▶ Two seconds before the picture is taken, the self-timer lamp will light up and the beeper will sound faster.



If you do not look through the viewfinder when you press the shutter button, attach the eyepiece cover (p.183). If stray light enters the viewfinder when the picture is taken, it may throw off the exposure.



- The <🕒2> enables you to shoot while not touching the camera mounted on a tripod. This prevents camera shake while you shoot still lifes or long exposures.
- After taking self-timer shots, playing back the image (p.290) to check focus and exposure is recommended.
- When using the self-timer to shoot only yourself, use focus lock (p.75) on an object at about the same distance as where you will stand.
- To cancel the self-timer after it starts, press the <DRIVE> button.

4

Image Settings

This chapter explains image-related function settings: Image-recording quality, ISO speed, Picture Style, white balance, Auto Lighting Optimizer, lens peripheral illumination correction, chromatic aberration correction, and other functions.

- In Basic Zone modes, only the following can be set as described in this chapter: Image-recording quality, lens peripheral illumination correction, lens chromatic aberration correction, folder creation and selection, and image file numbering.
- The ☆ icon at the upper right of the page title indicates that the function is available only in Creative Zone modes (**P/Tv/Av/M/B**).

MENU Setting the Image-Recording Quality

You can select the pixel count and the image quality. There are eight JPEG image-recording quality settings: **L**, **L**, **M**, **M**, **S1**, **S1**, **S2**, **S3**. There are three RAW image quality settings: **RAW**, **M RAW**, **S RAW** (p.118).

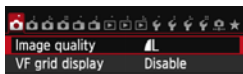

1 Select [Image quality].

- Under the [1] tab, select [Image quality], then press <SET>.

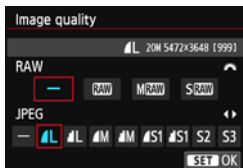

2 Select the image-recording quality.

- To select a RAW setting, turn the <DIAL> dial. To select a JPEG setting, press the <◀▶> key.
- On the upper right of the screen, "****M (megapixels) **** x ****" indicates the recorded pixel count, and [***] is the number of possible shots (displayed up to 999).
- Press <SET> to set it.

Image-recording Quality Setting Examples

L only

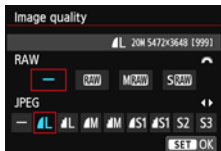

RAW + L

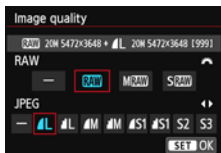

RAW only

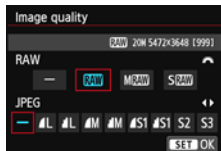

S RAW + M

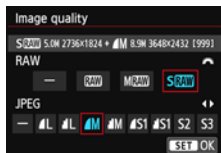

If [-] is set for both RAW and JPEG, **L** will be set.

Guide to Image-Recording Quality Settings (Approx.)

Image Quality		Pixels Recorded	Printing Size	File Size (MB)	Possible Shots	Maximum Burst
JPEG	L	20M	A2	6.6	1000	40 (65)
	L			3.5	1920	130 (1920)
	M	8.9M	A3	3.6	1840	100 (1840)
	M			1.8	3410	3410 (3410)
	S1	5.0M	A4	2.3	2790	430 (2790)
	S1			1.2	5200	5200 (5200)
	S2*1	2.5M	9x13 cm	1.3	4990	4990 (4990)
	S3*2	0.3M	-	0.3	19380	19380 (19380)
RAW	RAW	20M	A2	24.0	260	15 (16)
	M RAW	11M	A3	19.3	370	9 (10)
	S RAW	5.0M	A4	13.3	470	11 (13)
RAW + JPEG	RAW	20M	A2	24.0+6.6	200	8 (8)
	L	20M	A2			
	M RAW	11M	A3	19.3+6.6	270	8 (8)
	L	20M	A2			
	S RAW	5.0M	A4	13.3+6.6	320	8 (8)
L	20M	A2				



*1: S2 is suitable for playing the images on a digital photo frame.

*2: S3 is suitable for emailing the image or using it on a Web site.

- S2 and S3 will be in (Fine) quality.
- The file size, possible shots, and maximum burst during continuous shooting are based on Canon's testing standards (3:2 aspect ratio, ISO 100 and Standard Picture Style) using an 8 GB card. **These figures will vary depending on the subject, card brand, aspect ratio, ISO speed, Picture Style, Custom Functions, and other settings.**
- The maximum burst applies to high-speed continuous shooting. Figures in parentheses apply to an UHS-I class 8 GB card based on Canon's testing standards.



Even if you use a UHS-I class card, the maximum burst indicator will not change. The maximum burst in parentheses in the table will apply instead.

- If you select both RAW and JPEG, the same image will be recorded simultaneously to the card in both RAW and JPEG at the image-recording qualities that were set. The two images will be recorded with the same file numbers (file extension: .JPG for JPEG and .CR2 for RAW).
- The image-recording quality icons are as follows: **RAW** (RAW), **M RAW** (Middle RAW), **S RAW** (Small RAW), JPEG,  (Fine),  (Normal), **L** (Large), **M** (Middle), **S** (Small).

RAW Images

A RAW image is raw data output by the image sensor converted to digital data. It is recorded to the card as is, and you can select the quality as follows: **RAW**, **M RAW**, or **S RAW**.

A **RAW** image can be processed with [] **1: RAW image processing** (p.328) and saved as a JPEG image. (**M RAW** and **S RAW** images cannot be processed with the camera.) While the RAW image itself does not change, you can process the RAW image according to different conditions to create any number of JPEG images from it.

With all RAW images, you can use Digital Photo Professional (provided software, p.456) to make various adjustments and then generate a JPEG, TIFF, etc., image incorporating those adjustments.

- To display RAW images on a computer, using the provided software is recommended (p.456).
- Commercially-available software may not be able to display RAW images taken by the camera. For details on commercially-available software, contact the software manufacturer.

Maximum Burst During Continuous Shooting

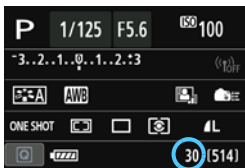

The approximate maximum burst is displayed on the bottom right in the viewfinder and on the shooting function settings screen.

If the maximum burst for continuous shooting is 99 or higher, “99” will be displayed.



The maximum burst is displayed even when a card is not inserted in the camera. Make sure that a card is inserted before taking a picture.



If the maximum burst is displayed as “99”, it indicates that you can shoot 99 or more shots continuously. If the maximum burst decreases to 98 or lower and the internal buffer memory becomes full, “buSY” will be displayed in the viewfinder and on the LCD panel. Shooting will then be disabled temporarily. If you stop continuous shooting, the maximum burst will increase. After all the captured images are written to the card, you can resume continuous shooting and shoot up to the maximum burst listed in the table on page 117.

ISO: Setting the ISO Speed ☆

Set the ISO speed (image sensor's sensitivity to light) to suit the ambient light level. In Basic Zone modes, the ISO speed is set automatically (p.122).

Regarding the ISO speed during movie shooting, see pages 254 and 257.

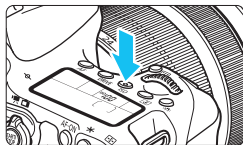

1 Press the <ISO> button. (📷6)

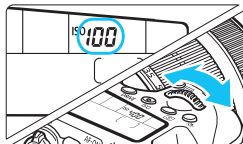

2 Set the ISO speed.

- While looking at the LCD panel or the viewfinder, turn the <📷> or <📷> dial.
- ISO speed can be set within ISO 100 - ISO 12800 in 1/3-stop increments.
- “A” indicates Auto ISO. The ISO speed will be set automatically (p.122).
- When the screen shown on the left is displayed, you can press the <INFO.> button to set it to “AUTO”.

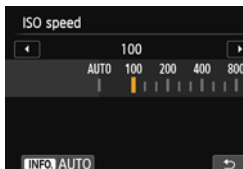

ISO Speed Guide

ISO Speed	Shooting Situation (No flash)	Flash Range
ISO 100 - ISO 400	Sunny outdoors	The higher the ISO speed, the farther the flash range will be.
ISO 400 - ISO 1600	Overcast skies or evening time	
ISO 1600 - ISO 12800, H	Dark indoors or night	

* High ISO speeds will result in grainier images.



- If [**4: Highlight tone priority**] is set to **[Enable]**, ISO 100/125/160 and "H" (equivalent to ISO 25600) cannot be set (p.145).
- Shooting in high temperatures may result in images that look grainier. Long exposures can also cause irregular colors in the image.
- When you shoot at high ISO speeds, noise (such as dots of light and banding) may become noticeable.
- When shooting in conditions that produce an extreme amount of noise, such as a combination of high ISO speed, high temperature and long exposure, images may not be recorded properly.
- As "H" (equivalent to ISO 25600) is an expanded ISO speed setting, noise (such as dots of light and banding) and irregular colors will be more noticeable, and the resolution will be lower than usual.
- If you use a high ISO speed and flash to shoot a close subject, overexposure may result.
- If you shoot a movie while "H" (equivalent to ISO 25600) is set, it will switch to ISO 12800 (with movie manual exposure shooting). Even if you switch back to still photo shooting, the ISO speed will not revert to the original setting.



- Under [**3: ISO speed settings**], you can use **[ISO speed range]** to expand the settable ISO speed range up to ISO 25600 (H) (p.123).
- <ⓘ> can be displayed in the viewfinder when you set the "H" expanded ISO speed (p.376).

Auto ISO

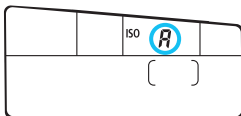

If the ISO speed is set to “A” (Auto), the actual ISO speed to be set will be displayed when you press the shutter button halfway.

As indicated below, the ISO speed will be set automatically to suit the shooting mode.

Shooting Mode		ISO Speed Setting
/ /		Automatically set within ISO 100 - ISO 6400
SCN	/ / / /	Automatically set within ISO 100 - ISO 1600
		Automatically set within ISO 100 - ISO 12800
		Automatically set within ISO 100 - ISO 12800
P / Tv / Av / M		Automatically set within ISO 100 - ISO 12800* ¹
B		ISO 400* ¹
With flash		ISO 400* ¹ * ² * ³ * ⁴

*1 : The actual ISO speed range depends on the [Minimum] and [Maximum] settings set in [Auto ISO range].

*2 : If fill flash will cause overexposure, the minimum ISO 100 will be set (except in the **M** and **B** modes).

*3 : Except in the , , and modes.

*4 : When using bounce flash with an external Speedlite in the , , , , , or **P** mode, the ISO speed will be set automatically within ISO 400 - ISO 1600.

MENU Setting the ISO Speed Range

You can set the manually-settable ISO speed range (minimum and maximum limits). You can set the minimum limit within ISO 100 - ISO 12800 and the maximum limit within ISO 200 - H (equivalent to ISO 25600).

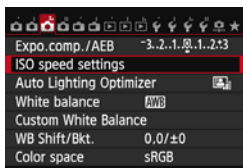
**1** Select [ISO speed settings].

- Under the [M/3] tab, select [ISO speed settings], then press <SET>.

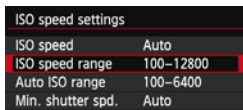
**2** Select [ISO speed range].

- Select [ISO speed range], then press <SET>.

**3** Set the minimum limit.

- Select the minimum limit box, then press <SET>.
- Press the <▲▼> key to select an ISO speed, then press <SET>.

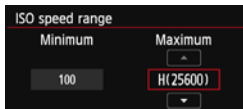
**4** Set the maximum limit.

- Select the maximum limit box, then press <SET>.
- Press the <▲▼> key to select an ISO speed, then press <SET>.

5 Exit the setting.

- Press the <◀▶> key to select [OK], then press <SET>.
- The menu reappears.

MENU Setting the ISO Speed Range for Auto ISO

You can set the automatic ISO speed range for Auto ISO within ISO 100 - ISO 12800. You can set the minimum limit within ISO 100 - ISO 6400, and the maximum limit within ISO 200 - ISO 12800 in whole-stop increments.

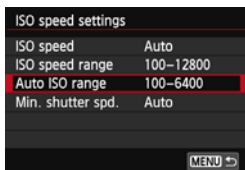
**1** Select **[Auto ISO range]**.

- Select **[Auto ISO range]**, then press $\langle \text{SET} \rangle$.

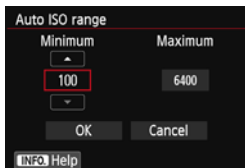
**2** Set the minimum limit.

- Select the minimum limit box, then press $\langle \text{SET} \rangle$.
- Press the $\langle \blacktriangle \nabla \rangle$ key to select an ISO speed, then press $\langle \text{SET} \rangle$.

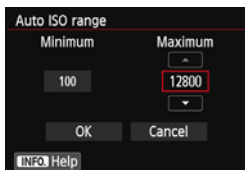
**3** Set the maximum limit.

- Select the maximum limit box, then press $\langle \text{SET} \rangle$.
- Press the $\langle \blacktriangle \nabla \rangle$ key to select an ISO speed, then press $\langle \text{SET} \rangle$.

4 Exit the setting.

- Press the $\langle \blacktriangleleft \blacktriangleright \rangle$ key to select **[OK]**, then press $\langle \text{SET} \rangle$.
- ▶ The menu reappears.

The **[Minimum]** and **[Maximum]** settings will also apply to the ISO speed selection's minimum and maximum ISO speeds (p.367).

MENU Setting the Minimum Shutter Speed for Auto ISO

When Auto ISO is set, you can set the minimum shutter speed (1/250 sec. to 1 sec.) so that the automatically-set shutter speed is not too slow.

This is convenient in the <P> and <Av> modes when you use a wide-angle lens to shoot a moving subject. You can minimize both camera shake and subject blur.

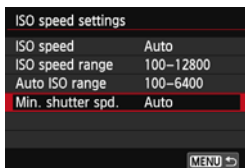

1 Select [Min. shutter spd.].

- Select [Min. shutter spd.], then press <SET>.

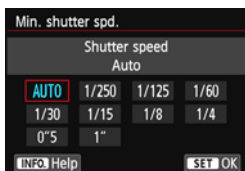

2 Set the desired minimum shutter speed.

- Press the <◀▶> key to select the shutter speed, then press <SET>.
- ▶ The menu reappears.

- ❗ If a correct exposure cannot be obtained with the maximum ISO speed limit set with [Auto ISO range], a shutter speed slower than the [Min. shutter spd.] will be set to obtain a standard exposure.
- With flash photography, [Min. shutter spd.] will not be applied.



Selecting a Picture Style ☆

By selecting a Picture Style, you can obtain image characteristics matching your photographic expression or the subject.

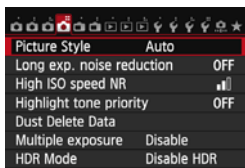
In Basic Zone modes, <A> (Auto) is set automatically.





1 Select [Picture Style].

- Under the [4] tab, select [Picture Style], then press <SET>.
- ▶ The Picture Style selection screen will appear.



2 Select a Picture Style.

- Press the <▲> key to select a Picture Style, then press <SET>.
- ▶ The Picture Style will be set.

Picture Style Characteristics

Auto

The color tone will be adjusted automatically to suit the scene. The colors will look vivid, especially for blue skies, greenery, and sunsets in nature, outdoor, and sunset scenes.

 If the desired color tone is not obtained with [Auto], use another Picture Style.

Standard

The image looks vivid, sharp, and crisp. This is a general-purpose Picture Style suitable for most scenes.

Portrait

For nice skin tones. The image looks softer. Suited for close-up portraits.

By changing the [Color tone] (p.129), you can adjust the skin tone.

 **Landscape**

For vivid blues and greens, and very sharp and crisp images. Effective for impressive landscapes.

 **Neutral**

This Picture Style is for users who prefer to process images with their computer. For natural colors and subdued images.

 **Faithful**

This Picture Style is for users who prefer to process images with their computer. When the subject is captured under a color temperature of 5200 K, the color is adjusted colorimetrically to match the subject's color. Images will appear dull and subdued.

 **Monochrome**

Creates black-and-white images.



Black-and-white images shot in JPEG cannot be reverted to color. If you want to later shoot pictures in color, make sure the **[Monochrome]** setting has been canceled.



< > can be displayed in the viewfinder when **[Monochrome]** is set (p.376).

 **User Def. 1-3**

You can register a basic style such as **[Portrait]**, **[Landscape]**, a Picture Style file, etc., and adjust it as desired (p.132). Any User Defined Picture Style that has not been set will have the same default settings as the **[Auto]** Picture Style.

Symbols

The symbols of the Picture Style selection screen refer to parameters such as **[Sharpness]** and **[Contrast]**. The numerals indicate the parameter settings, such as for **[Sharpness]** and **[Contrast]**, for each Picture Style.



Symbols

	Sharpness
	Contrast
	Saturation
	Color tone
	Filter effect (Monochrome)
	Toning effect (Monochrome)

Customizing a Picture Style ☆

You can customize a Picture Style by adjusting individual parameters such as **[Sharpness]** and **[Contrast]**. To see the resulting effects, take test shots. To customize **[Monochrome]**, see page 131.

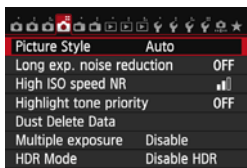

1 Select **[Picture Style]**.

- Under the **[P4]** tab, select **[Picture Style]**, then press **<SET>**.
- ▶ The Picture Style selection screen will appear.



2 Select a Picture Style.

- Select a Picture Style, then press the **<INFO.>** button.

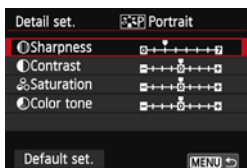

3 Select a parameter.

- Select a parameter such as **[Sharpness]**, then press **<SET>**.

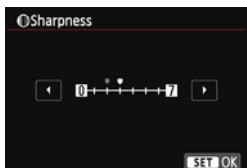

4 Set the parameter.

- Press the **<◀▶>** key to adjust the parameter as desired, then press **<SET>**.



- Press the <MENU> button to save the adjusted parameters. The Picture Style selection screen will reappear.
- ▶ Any parameter settings different from the default will be displayed in blue.

Parameter Settings and Effects

Sharpness	0: Less sharp outline	+7: Sharp outline
Contrast	-4: Low contrast	+4: High contrast
Saturation	-4: Low saturation	+4: High saturation
Color tone	-4: Reddish skin tone	+4: Yellowish skin tone

- By selecting [**Default set.**] in step 3, you can revert the respective Picture Style to its default parameter settings.
- To use the adjusted Picture Style, first select the adjusted Picture Style, then shoot.

Monochrome Adjustment

For Monochrome, you can also set **[Filter effect]** and **[Toning effect]** in addition to **[Sharpness]** and **[Contrast]** explained on the preceding page.

Filter Effect

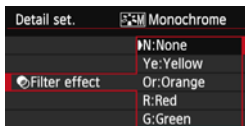

With a filter effect applied to a monochrome image, you can make white clouds or green trees stand out more.

Filter	Sample Effects
N: None	Normal black-and-white image with no filter effects.
Ye: Yellow	The blue sky will look more natural, and the white clouds will look crisper.
Or: Orange	The blue sky will look slightly darker. The sunset will look more brilliant.
R: Red	The blue sky will look quite dark. Fall leaves will look crisper and brighter.
G: Green	Skin tones and lips will appear muted. Green tree leaves will look crisper and brighter.

Increasing the **[Contrast]** will make the filter effect more pronounced.

Toning Effect

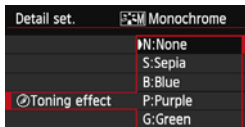

By applying a toning effect, you can create a monochrome image in that color. It can make the image look more impressive.

The following can be selected: **[N:None]**, **[S:Sepia]**, **[B:Blue]**, **[P:Purple]** or **[G:Green]**.

🔧 Registering a Picture Style ☆

You can select a base Picture Style such as [Portrait] or [Landscape], adjust its parameters as desired and register it under [User Def. 1], [User Def. 2], or [User Def. 3].

You can create multiple Picture Styles with different settings for parameters such as sharpness and contrast.

You can also adjust the parameters of a Picture Style that has been registered to the camera with EOS Utility (provided software, p.456).

1 Select [Picture Style].

- Under the [📷4] tab, select [Picture Style], then press <SET>.
- ▶ The Picture Style selection screen will appear.

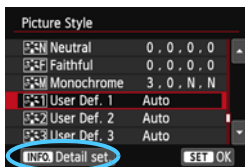

2 Select [User Def. *].

- Select [User Def. *], then press <INFO.>.

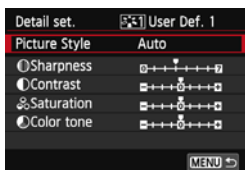

3 Press <SET>.

- With [Picture Style] selected, press <SET>.



4 Select the base Picture Style.

- Press the <▲▼> <◀▶> keys to select the base Picture Style, then press <SET>.
- To adjust the parameters of a Picture Style that has been registered to the camera with EOS Utility (provided software), select the Picture Style here.



5 Select a parameter.

- Select a parameter such as **[Sharpness]**, then press **<SET>**.



6 Set the parameter.

- Press the **<◀▶>** key to adjust the parameter as desired, then press **<SET>**.
For details, see “Customizing a Picture Style” on page 129.
- Press the **<MENU>** button to register the modified Picture Style. The Picture Style selection screen will then reappear.
 - ▶ The base Picture Style will be indicated on the right of **[User Def. *]**.
 - ▶ If the settings in a Picture Style registered under **[User Def. *]** have been modified from the base Picture Style settings, the Picture Style's name will be displayed in blue.

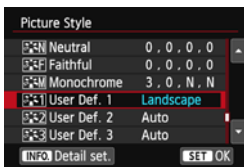

- If a Picture Style has already been registered under **[User Def. *]**, changing the base Picture Style in step 4 will nullify the parameter settings of the registered Picture Style.
- If you execute **[Clear all camera settings]** (p.61), all the **[User Def. *]** settings will revert to their defaults. Picture Styles registered via EOS Utility (provided software) will have only their modified parameters reverted to their default settings.

- To use the adjusted Picture Style, select the registered **[User Def. *]**, then shoot.
- Regarding the procedure to register a Picture Style file to the camera, refer to the EOS Utility Instruction Manual (p.459).

MENU Setting the White Balance ☆

White balance (WB) is for making the white areas look white. Normally, the <AWB> (Auto) setting will obtain the correct white balance. If natural-looking colors cannot be obtained with <AWB>, you can select the white balance to match the light source or set it manually by shooting a white object.

In Basic Zone modes, <AWB> is set automatically.

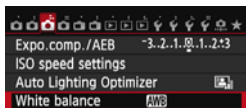

1 Select [White balance].

- Under the [CAMERA] tab, select [White balance], then press <SET>.

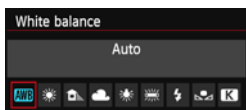

2 Select a white balance setting.

- Select the desired setting, then press <SET>.

Display	Mode	Color Temperature (Approx. K : Kelvin)
AWB	Auto	3000-7000
☀	Daylight	5200
🏠	Shade	7000
☁	Cloudy, twilight, sunset	6000
☀	Tungsten light	3200
💡	White fluorescent light	4000
⚡	Flash use	Automatically set*
📷	Custom (p.135)	2000-10000
K	Color temperature (p.137)	2500-10000

* Applicable with Speedlites having a color temperature transmission function. Otherwise, it will be fixed to approx. 6000 K.

White Balance

To the human eye, a white object looks white regardless of the type of lighting. With a digital camera, the color temperature is adjusted with software to make the white areas look white. This adjustment serves as the basis for the color correction. With this function, pictures with natural color shades can be taken.

Custom White Balance

Custom white balance enables you to manually set the white balance for a specific light source for better accuracy. Perform this procedure under the actual light source to be used.



1 Shoot a white object.

- Look through the viewfinder and aim the entire dotted line box (shown in the illustration) over a plain, white object.
- Focus manually and set the standard exposure for the white object.
- You can use any white balance setting.



2 Select [Custom White Balance].

- Under the [CAMERA] tab, select [Custom White Balance], then press <SET>.
- ▶ The custom white balance selection screen will appear.



3 Import the white balance data.

- Turn the <DISK> dial to select the image captured in step 1, then press <SET>.
- ▶ On the dialog screen that appears, select [OK] and the data will be imported.

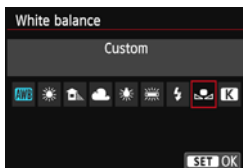

4 Select [White balance].

- Under the [📷3] tab, select [White balance], then press <SET>.

5 Select the custom white balance.

- Select [📷], then press <SET>.

- ⚠ ● If the exposure obtained in step 1 differs greatly from the standard exposure, a correct white balance may not be obtained.
- In step 3, the following images cannot be selected: images captured while the Picture Style was set to [Monochrome], multiple-exposure images, and images shot with another camera.

- 📄 ● Instead of a white object, a gray chart or 18% gray reflector (commercially available) can produce a more accurate white balance.
- The personal white balance registered with the provided software will be registered under [📷]. If you execute step 3, the data for the registered personal white balance will be erased.

K Setting the Color Temperature

You can set the white balance's color temperature numerically. This is for advanced users.

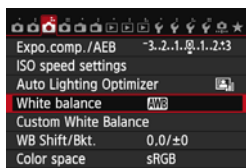

1 Select [White balance].

- Under the [CAMERA 3] tab, select [White balance], then press <SET>.

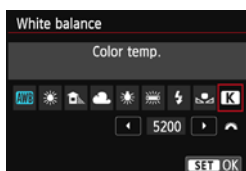

2 Set the color temperature.

- Select [K].
- Turn the <DIAL> dial to set the color temperature, then press <SET>.
- The color temperature can be set from approx. 2500 K to 10000 K in 100 K increments.



- When setting the color temperature for an artificial light source, set white balance correction (magenta or green) as necessary.
- If you set [K] to the reading taken with a commercially-available color temperature meter, take test shots and adjust the setting to compensate for the difference between the color temperature meter's reading and the camera's color temperature reading.

MENU White Balance Correction ☆

You can correct the white balance that has been set. This adjustment will have the same effect as using a commercially-available color temperature conversion filter or color compensating filter. Each color can be corrected to one of nine levels.

This function is for advanced users who are familiar with using color temperature conversion or color compensating filters.

White Balance Correction



1 Select [WB Shift/Bkt.].

- Under the [CAMERA 3] tab, select [WB Shift/Bkt.], then press <SET>.

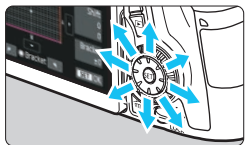

2 Set the white balance correction.

- Use <MULTISELECTOR> to move the "■" mark to the desired position.
- B is for blue, A for amber, M for magenta, and G for green. The color in the respective direction will be corrected.
- On the right of the screen, "Shift" indicates the direction and correction amount.
- Pressing the <DELETE> button will cancel all the [WB Shift/Bkt.] settings.
- Press <SET> to exit the setting and return to the menu.

Sample setting: A2, G1

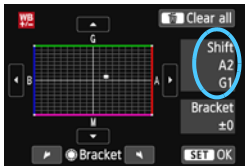

- <INFO> can be displayed in the viewfinder when white balance correction is set (p.376).
- One level of the blue/amber correction is equivalent to approx. 5 mireds of a color temperature conversion filter. (Mired: Measuring unit indicating the density of a color temperature conversion filter.)

White Balance Auto Bracketing

With just one shot, three images with different color tones can be recorded simultaneously. Based on the color temperature of the current white balance setting, the image will be bracketed with a blue/amber bias or magenta/green bias. This is called white balance bracketing (WB-BKT). White balance bracketing is possible up to ± 3 levels in single-level increments.

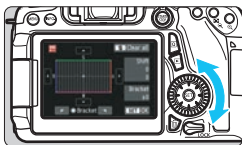

B/A bias ± 3 levels

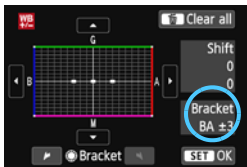

Set the white balance bracketing amount.

- In step 2 for “White Balance Correction”, when you turn the $\langle \odot \rangle$ dial, the “■” mark on the screen will change to “■■■” (3 points). Turning the dial to the right sets the B/A bracketing, and turning it to the left sets the M/G bracketing.
- ▶ On the right, “Bracket” indicates the bracketing direction and correction amount.
- Pressing the $\langle \overline{\text{w}} \rangle$ button will cancel all the [WB Shift/Bkt.] settings.
- Press $\langle \text{SET} \rangle$ to exit the setting and return to the menu.

Bracketing Sequence

The images will be bracketed in the following sequence: 1. Standard white balance, 2. Blue (B) bias, and 3. Amber (A) bias, or 1. Standard white balance, 2. Magenta (M) bias, and 3. Green (G) bias.



- During WB bracketing, the maximum burst for continuous shooting will be lower and the number of possible shots will also decrease to approx. one-third the normal number.
- You can also set white balance correction and AEB together with white balance bracketing. If you set AEB in combination with white balance bracketing, a total of nine images will be recorded for a single shot.
- Since three images are recorded for one shot, it takes longer to record the shot to the card.
- You can change the number of shots for white balance bracketing (p.366).
- “Bkt.” stands for bracketing.

MENU Auto Correction of Brightness and Contrast ☆

If the image comes out dark or the contrast is low, the brightness and contrast can be corrected automatically. This function is called Auto Lighting Optimizer. The default setting is [Standard]. With JPEG images, the correction is applied when the image is captured.

In Basic Zone modes, [Standard] is set automatically.



1 Select [Auto Lighting Optimizer].

- Under the [CAMERA] tab, select [Auto Lighting Optimizer], then press <SET>.



2 Select the setting.

- Select the desired setting, then press <SET>.

3 Take the picture.

- The image will be recorded with the brightness and contrast corrected if necessary.

- If [CAMERA 4: Highlight tone priority] is set to [Enable], the Auto Lighting Optimizer will be set automatically to [Disable] and the setting cannot be changed.
- Depending on the shooting conditions, noise may increase.
- If a setting other than [Disable] is set and you use exposure compensation or flash exposure compensation to darken the exposure, the image may still come out bright. If you want a darker exposure, set this function to [Disable].
- If the HDR mode (p.172) or multiple-exposure shooting (p.175) is set, the Auto Lighting Optimizer will be set automatically to [Disable]. When the HDR mode or multiple-exposure shooting is canceled, the Auto Lighting Optimizer will revert to the original setting.

In step 2, if you press the <INFO.> button and uncheck <✓> the [Disabled in M or B modes] setting, the Auto Lighting Optimizer can also be set in the <M> and modes.

MENU Setting Noise Reduction ☆

High ISO Speed Noise Reduction

This function reduces the noise generated in the image. Although noise reduction is applied at all ISO speeds, it is particularly effective at high ISO speeds. At low ISO speeds, the noise in the darker parts of the image (shadow areas) is further reduced.

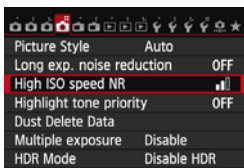

1 Select [High ISO speed NR].

- Under the [CAMERA] tab, select [High ISO speed NR], then press <SET>.

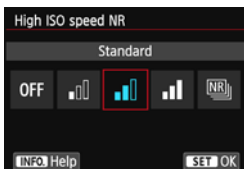

2 Set the level.

- Select the desired noise reduction level, then press <SET>.





• [NR] : Multi Shot Noise Reduction

This applies noise reduction with higher image quality than [High]. For a single photo, four shots are taken continuously and aligned and merged automatically into a single JPEG image.

3 Take the picture.

- The image will be recorded with noise reduction applied.

Cautions for Setting Multi Shot Noise Reduction

- If there is significant misalignment in the image due to camera shake, the noise reduction effect may be minimal.
- If you are handholding the camera, keep it steady to prevent camera shake. Using a tripod is recommended.
- If you shoot a moving subject, the subject's movement may leave afterimages or the surrounding area of the subject may become dark.
- The image alignment may not function properly with repetitive patterns (lattice, stripes, etc.) or flat, single-tone images.
- Recording the image to the card will take longer than with normal shooting. During the processing of the images, "buSY" will be displayed in the viewfinder and on the LCD panel and you cannot take another picture until the processing is completed.
- RAW images cannot be selected. You cannot use AEB and WB bracketing. [4: Long exp. noise reduction], [4: Dust Delete Data], [4: Multiple exposure], and [4: HDR Mode] cannot be set. If any of these has already been selected or set, [**Multi Shot Noise Reduction**] cannot be set.
- Flash shooting is not possible. The AF-assist beam will be emitted according to the [C.Fn II-5: AF-assist beam firing] setting.
- You cannot set [**Multi Shot Noise Reduction**] for bulb exposures.
- If you turn off the power, change the shooting mode to a Basic Zone mode or bulb, or switch to movie shooting, the setting will automatically switch to [**Standard**].
- Direct printing is not possible (p.346).

 If you play back a **RAW** image with the camera or print an image directly, the effect of the high ISO speed noise reduction may look minimal. Check the noise reduction effect or print noise-reduced images with Digital Photo Professional (provided software, p.456).

Long Exposure Noise Reduction

Noise reduction is possible with images exposed for 1 sec. or longer.

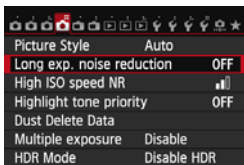

1 Select [Long exp. noise reduction].

- Under the [CAMERA] tab, select [Long exp. noise reduction], then press <SET>.

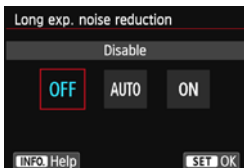

2 Set the desired setting.

- Select the desired setting, then press <SET>.

• Auto

For exposures of 1 sec. or longer, noise reduction is performed automatically if noise typical of long exposures is detected. This [Auto] setting is effective in most cases.

• Enable

Noise reduction is performed for all exposures of 1 sec. or longer. The [Enable] setting can reduce noise that cannot be detected with the [Auto] setting.

3 Take the picture.

- The image will be recorded with noise reduction applied.

- With **[Auto]** and **[Enable]**, the noise reduction process after the picture is taken may take the same amount of time as that for the exposure. During noise reduction, shooting is still possible as long as the maximum burst indicator in the viewfinder shows “1” or higher.
- Images taken at ISO 1600 or higher may look grainier with the **[Enable]** setting than with the **[Disable]** or **[Auto]** setting.
- With **[Enable]**, if a long exposure is shot with the Live View image displayed, “**buSY**” will be displayed during the noise reduction process. The Live View display will not appear until the noise reduction is completed. (You cannot take another picture.)

MENU Highlight Tone Priority ☆

You can minimize overexposed highlight areas.

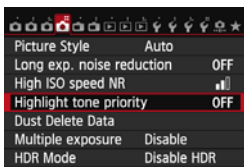

1 Select [Highlight tone priority].

- Under the [**4**] tab, select [**Highlight tone priority**], then press <SET>.

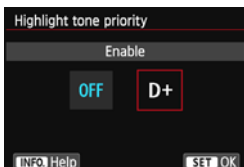

2 Select [Enable].

- Select [**Enable**], then press <SET>.
- Highlight details are improved. The dynamic range is expanded from the standard 18% gray to bright highlights. The gradation between the grays and highlights becomes smoother.

3 Take the picture.

- The image will be recorded with highlight tone priority applied.



- With [**Enable**], the Auto Lighting Optimizer (p.140) is automatically set to [**Disable**] and the setting cannot be changed. When [**Highlight tone priority**] is set to [**Disable**], the Auto Lighting Optimizer will revert to its original setting.
- With [**Enable**], image noise (graininess and banding, etc.) may increase slightly more than with [**Disable**].



With [**Enable**], the settable range will be ISO 200 - ISO 12800 (up to ISO 6400 for movies). Also, the <D+> icon will be displayed in the viewfinder and on the LCD panel when highlight tone priority is enabled.

MENU Lens Peripheral Illumination / Chromatic Aberration Correction

Peripheral light fall-off is a phenomenon that makes the image corners look darker due to the lens characteristics. Color fringing along subject outlines is called chromatic aberration. Both lens aberrations can be corrected. The default settings are **[Enable]** for both corrections.

Peripheral Illumination Correction

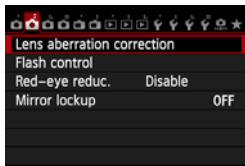

1 Select **[Lens aberration correction]**.

- Under the [**2**] tab, select **[Lens aberration correction]**, then press **<SET>**.

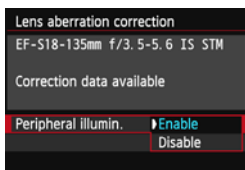

2 Select the setting.

- Check that **[Correction data available]** is displayed for the attached lens.
- Select **[Peripheral illumin.]**, then press **<SET>**.
- Select **[Enable]**, then press **<SET>**.
- If **[Correction data not available]** is displayed, see “Lens Correction Data” on page 148.

3 Take the picture.

- The image will be recorded with the peripheral illumination corrected.

 Depending on shooting conditions, noise may appear on the image periphery.

- The correction amount applied will be lower than the maximum correction amount settable with Digital Photo Professional (provided software, p.456).
- The higher the ISO speed, the lower the correction amount will be.

Chromatic Aberration Correction

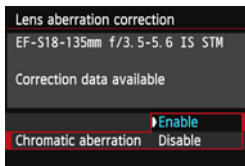

1 Select the setting.

- Check that [**Correction data available**] is displayed for the attached lens.
- Select [**Chromatic aberration**], then press <ⓈET>.
- Select [**Enable**], then press <ⓈET>.
- If [**Correction data not available**] is displayed, see “Lens Correction Data” on the next page.

2 Take the picture.

- The image will be recorded with the chromatic aberration corrected.





If you play back a **RAW** image shot with the chromatic aberration corrected, the image will be displayed on the camera without the chromatic aberration correction applied. Check the chromatic aberration correction with Digital Photo Professional (provided software, p.456).

Lens Correction Data

The camera already contains lens peripheral illumination correction data and chromatic aberration correction data for approx. 25 lenses. If you select **[Enable]**, the peripheral illumination correction and chromatic aberration correction will be applied automatically for any lens whose correction data is registered in the camera.

With EOS Utility (provided software), you can check which lenses have their correction data registered in the camera. You can also register the correction data for unregistered lenses. For details, refer to the EOS Utility Instruction Manual (p.459) on the Software Instruction Manual CD-ROM.

Notes for Peripheral Illumination Correction and Chromatic Aberration Correction

-  ● Peripheral illumination correction and chromatic aberration correction cannot be applied to JPEG images already taken.
 - When using a non-Canon lens, setting the corrections to **[Disable]** is recommended, even if **[Correction data available]** is displayed.
 - If you use magnified view during Live View shooting, the peripheral illumination correction and chromatic aberration correction will not be reflected in the image shown on the screen.
-
-  ● If the effect of the correction is not visible, magnify the image after shooting and check it again.
 - Corrections can be applied even when an Extender or Life-size Converter is attached.
 - If the correction data for the attached lens is not registered to the camera, the result will be the same as when the correction is set to **[Disable]**.
 - If the lens does not have distance information, the correction amount will be lower.

MENU Creating and Selecting a Folder

You can freely create and select the folder where the captured images are to be saved.

This operation is optional since a folder will be created automatically for saving captured images.

Creating a Folder

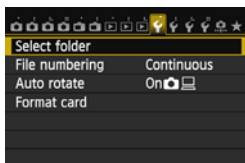

1 Select [Select folder].

- Under the [**1**] tab, select [**Select folder**], then press <SET>.

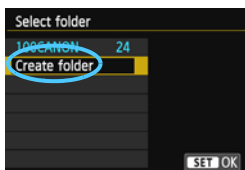

2 Select [Create folder].

- Select [**Create folder**], then press <SET>.

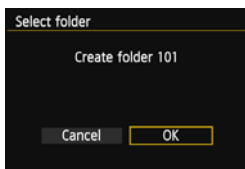

3 Create a new folder.

- Select [**OK**], then press <SET>.
- ▶ A new folder with the folder number increased by one is created.

Selecting a Folder



- With the folder selection screen displayed, select a folder and press **<SET>**.
- ▶ The folder where the captured images will be saved is selected.
- Subsequent captured images will be recorded into the selected folder.



Folders

As with “**100CANON**” for example, the folder name starts with three digits (the folder number) followed by five alphanumeric characters. A folder can contain up to 9999 images (file number 0001 - 9999). When a folder becomes full, a new folder with the folder number increased by one is created automatically. Also, if manual reset (p.152) is executed, a new folder will be created automatically. Folders numbered from 100 to 999 can be created.

Creating Folders with a Computer

With the card open on the screen, create a new folder named “**DCIM**”. Open the DCIM folder and create as many folders as necessary to save and organize your images. The folder name must follow the format “**100ABC_D**”. The first three digits are the folder number, from 100 to 999. The final five characters can be any combination of upper- and lower-case letters from A to Z, numerals, and the underscore “_”. The space cannot be used. Also note that two folder names cannot share the same three-digit folder number (for example, “**100ABC_D**” and “**100W_XYZ**”), even if the other five characters in each name are different.

MENU File Numbering Methods

The image files will be numbered from 0001 to 9999 in the order the images are taken, then saved in a folder. You can change how the file number is assigned.

(Example) **IMG_0001.JPG**
File number

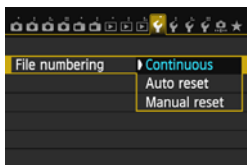

- 1 Select [File numbering].**
 - Under the [**1**] tab, select [**File numbering**], then press <SET>.
- 2 Select the file numbering method.**
 - Select the desired setting, then press <SET>.

Continuous

Continues the file numbering sequence even after the card is replaced or a new folder is created.

Even after you replace the card or create a new folder, the file numbering continues in sequence up to 9999. This is convenient when you want to save images numbered anywhere between 0001 to 9999 in multiple cards or folders into one folder in your computer.

If the replacement card or existing folder already contains images recorded previously, the file numbering of the new images may continue from the file numbering of the existing images on the card or in the folder. If you want to use continuous file numbering, it is recommended that you use a newly-formatted card each time.

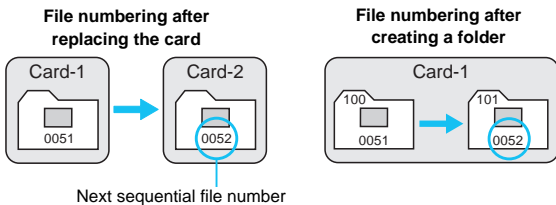

Auto Reset

The file numbering restarts from 0001 each time the card is replaced or a new folder is created.

When you replace the card or create a folder, the file numbering restarts from 0001 for the new images saved. This is convenient if you want to organize images according to cards or folders.

If the replacement card or existing folder already contains images recorded previously, the file numbering of the new images may continue from the file numbering of the existing images on the card or in the folder. If you want to save images with the file numbering starting from 0001, use a newly formatted card each time.

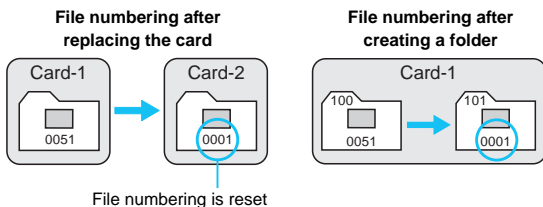

Manual Reset

To reset the file numbering to 0001 or to start from file number 0001 in a new folder.

When you reset the file numbering manually, a new folder is created automatically and the file numbering of images saved to that folder starts from 0001.

This is convenient if you want to use different folders for the images taken yesterday and the ones taken today, for example. After the manual reset, the file numbering returns to continuous or auto reset. (There will be no manual reset confirmation screen.)

! If the file number in folder 999 reaches 9999, shooting will not be possible even if the card still has storage capacity. The LCD monitor will display a message telling you to replace the card. Replace it with a new card.

📁 For both JPEG and RAW images, the file name will start with "IMG_". Movie file names will start with "MVI_". The extension will be ".JPG" for JPEG images, ".CR2" for RAW images, and ".MOV" for movies.

MENU Setting Copyright Information ☆

When you set the copyright information, it will be recorded to the image as Exif information.

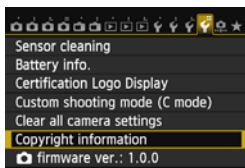

1 Select [Copyright information].

- Under the [**4**] tab, select [**Copyright information**], then press <SET>.

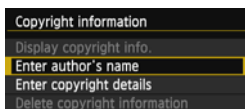

2 Select the option to be set.

- Select [**Enter author's name**] or [**Enter copyright details**], then press <SET>.



3 Enter text.

- Press the <Q> button. The text palette will be highlighted in a color frame, and text can be entered.
- Press the <▲▼> <◀▶> keys to move the yellow frame.
- By selecting [**Aa=1@**] and pressing <SET>, you can change the input mode.
- Select the desired character, then press <SET>.
- You can enter up to 63 characters.
- To delete a character, press the <🗑️> button.
- To cancel the text entry, press the <INFO.> button, then select [**OK**] on the confirmation screen.

4 Exit the setting.

- After entering the text, press the <MENU> button, then select [OK].
- ▶ The information will be saved and the screen will return to step 2.

Checking the Copyright Information

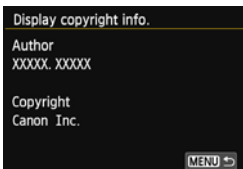

When you select [**Display copyright info.**] in step 2, you can check the [**Author**] and [**Copyright**] information that you entered.

Deleting the Copyright Information

When you select [**Delete copyright information**] in step 2 on the preceding page, you can delete the [**Author**] and [**Copyright**] information.

 You can also set or check the copyright information with EOS Utility (provided software, p.456).

MENU Setting the Color Space ☆

The range of reproducible colors is called the color space. With this camera, you can set the color space for captured images to sRGB or Adobe RGB. For normal shooting, sRGB is recommended. In Basic Zone modes, sRGB is set automatically.

1 Select [Color space].

- Under the [CAMERA 3] tab, select [Color space], then press <SET>.

2 Set the desired color space.

- Select [sRGB] or [Adobe RGB], then press <SET>.

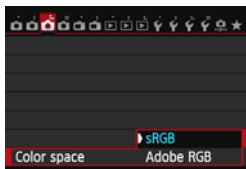

Adobe RGB

This color space is mainly used for commercial printing and other industrial uses. This setting is not recommended if you are not familiar with image processing, Adobe RGB, and Design rule for Camera File System 2.0 (Exif 2.21 or higher). The image will look very subdued in a sRGB computer environment and with printers not compatible with Design rule for Camera File System 2.0 (Exif 2.21 or higher). Post-processing of the image with computer software will therefore be required.



- If the captured still photo was shot in the Adobe RGB color space, the first character in the file name will be an underscore “_”.
- The ICC profile is not appended. Refer to explanations about the ICC profile in the Software Instruction Manual (p.459) on the CD-ROM.

5

Advanced Operations

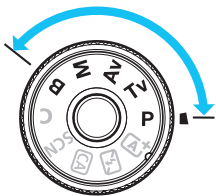

In Creative Zone modes, you can set the shutter speed and/or aperture to set the exposure as desired. By changing the camera settings, you can obtain various results.

- The ☆ icon at the upper right of the page title indicates that the function is available only in Creative Zone modes (**P/Tv/Av/M/B**).
- After you press the shutter button halfway and let go, the exposure values will remain displayed in the viewfinder and on the LCD panel for 4 sec. (🔒4).
- For the functions settable in each shooting mode, see page 404.



Set the <LOCK> switch downward.

P: Program AE

The camera automatically sets the shutter speed and aperture to suit the subject's brightness. This is called Program AE.

* <P> stands for Program.

* AE stands for Auto Exposure.



1 Set the Mode Dial to <P>.



2 Focus the subject.

- Look through the viewfinder and aim the AF point over the subject. Then press the shutter button halfway.
- ▶ When focus is achieved, the focus confirmation light <●> on the viewfinder's bottom right will light up (when in One-Shot AF mode).
- ▶ The shutter speed and aperture will be set automatically and displayed in the viewfinder and on the LCD panel.



3 Check the display.

- A standard exposure will be obtained as long as the shutter speed and aperture display do not blink.

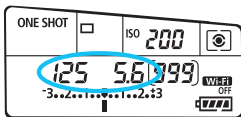

4 Take the picture.

- Compose the shot and press the shutter button completely.



- If the "30" shutter speed and the lower f/number blink, it indicates underexposure. Increase the ISO speed or use flash.
- If the "8000" shutter speed and the higher f/number blink, it indicates overexposure. Lower the ISO speed or use an ND filter (sold separately) to reduce the amount of light entering the lens.



Differences Between <P> and <A+> Modes

In the <A+> mode, many functions, such as the AF operation and metering mode, are set automatically to prevent spoiled shots. The functions you can set are limited. With <P> mode, only the shutter speed and aperture are set automatically. You can freely set the AF operation, metering mode, and other functions (p.404).

Program Shift

- In the Program AE mode, you can freely change the shutter speed and aperture combination (Program) set automatically by the camera while maintaining the same exposure. This is called Program shift.
- To shift the program, press the shutter button halfway, then turn the  dial until the desired shutter speed or aperture is displayed.
- Program shift will be canceled automatically when the metering timer (4) ends (exposure setting display turns off).
- Program shift cannot be used with flash.

Tv: Shutter-Priority AE

In this mode, you set the shutter speed and the camera automatically sets the aperture to obtain the standard exposure suiting the brightness of the subject. This is called shutter-priority AE. A faster shutter speed can freeze the action or a moving subject. A slower shutter speed can create a blurred effect, giving the impression of motion.

* <Tv> stands for Time value.



Blurred motion
(Slow shutter speed: 1/30 sec.)



Frozen action
(Fast shutter speed: 1/2000 sec.)



1 Set the Mode Dial to <Tv>.

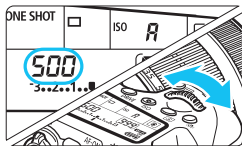

2 Set the desired shutter speed.

- While looking at the LCD panel, turn the <  > dial.

3 Focus the subject.

- Press the shutter button halfway.
- ▶ The aperture is set automatically.



4 Check the viewfinder display and shoot.

- As long as the aperture is not blinking, a standard exposure will be obtained.



- If the lower f/number blinks, it indicates underexposure. Turn the  dial to set a slower shutter speed until the aperture stops blinking or set a higher ISO speed.



- If the higher f/number blinks, it indicates overexposure. Turn the  dial to set a faster shutter speed until the aperture stops blinking or set a lower ISO speed.



Shutter Speed Display

The shutter speeds from “8000” to “4” indicate the denominator of the fractional shutter speed. For example, “125” indicates 1/125 sec., “0”5” indicates 0.5 sec. and “15” is 15 sec.

Av: Aperture-Priority AE

In this mode, you set the desired aperture and the camera sets the shutter speed automatically to obtain the standard exposure suiting the subject brightness. This is called aperture-priority AE. A higher f/ number (smaller aperture hole) will make more of the foreground and background fall within acceptable focus. On the other hand, a lower f/ number (larger aperture hole) will make less of the foreground and background fall within acceptable focus.

* <Av> stands for Aperture value (aperture opening).



Blurred background
(With a low aperture f/number: f/5.6)



Sharp foreground and background
(With a high aperture f/number: f/32)



1 Set the Mode Dial to <Av>.

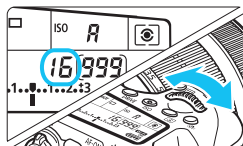

2 Set the desired aperture.

- While looking at the LCD panel, turn the <Aperture> dial.

3 Focus the subject.

- Press the shutter button halfway.
- ▶ The shutter speed is set automatically.



4 Check the viewfinder display and shoot.

- As long as the shutter speed is not blinking, a standard exposure will be obtained.



- If the “30” shutter speed blinks, it indicates underexposure. Turn the  dial to set a larger aperture (lower f/number) until the shutter speed blinking stops or set a higher ISO speed.



- If the “8000” shutter speed blinks, it indicates overexposure. Turn the  dial to set a smaller aperture (higher aperture f/number) until the shutter speed blinking stops or set a lower ISO speed.



Aperture Display

The higher the f/number, the smaller the aperture opening will be. The apertures displayed will differ depending on the lens. If no lens is attached to the camera, “00” will be displayed for the aperture.

Depth-of-Field Preview [☆]

The aperture opening (diaphragm) changes only at the moment when the picture is taken. Otherwise, the aperture remains fully open. Therefore, when you look at the scene through the viewfinder or on the LCD monitor, the depth of field will look narrow.

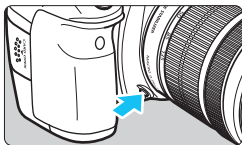

Press the depth-of-field preview button to stop down the lens to the current aperture setting and check the depth of field (range of acceptable focus).



- A higher f/number will make more of the foreground and background fall within acceptable focus. However, the viewfinder will look darker.
- The depth-of-field effect can be clearly seen on the Live View image as you change the aperture and press the depth-of-field preview button (p.216).
- The exposure will be locked (AE lock) while the depth-of-field preview button is pressed.

M: Manual Exposure

In this mode, you set both the shutter speed and aperture as desired. To determine the exposure, refer to the exposure level indicator in the viewfinder or use a commercially-available exposure meter. This method is called manual exposure.

* <M> stands for Manual.



1 Set the Mode Dial to <M>.

2 Set the ISO speed (p.120).

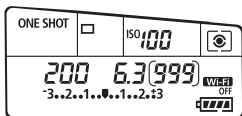

3 Set the shutter speed and aperture.

- To set the shutter speed, turn the <☀> dial.
- To set the aperture, turn the <⊙> dial.
- If it cannot be set, set the <LOCK> switch downward, then turn the <☀> or <⊙> dial.

Standard exposure index



Exposure level mark

4 Focus the subject.

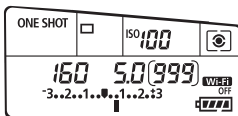

- Press the shutter button halfway.
- ▶ The exposure setting will be displayed in the viewfinder and on the LCD panel.
- The exposure level mark <|> indicates how far the current exposure level is from the standard exposure level.



5 Set the exposure and take the picture.

- Check the exposure level indicator and set the desired shutter speed and aperture.
- If the exposure level exceeds ± 3 stops from the standard exposure, the end of the exposure level indicator will display <◀> or <▶>.

 If Auto ISO is set, the ISO speed setting will change to suit the shutter speed and aperture in order to obtain a standard exposure. Therefore, you may not obtain the desired exposure effect.

-  In [ 3: Auto Lighting Optimizer], if the checkmark <√> for [Disabled in M or B modes] is removed, Auto Lighting Optimizer can be set in the <M> and modes (p.140).
- When Auto ISO is set, you can press the <★> button to lock the ISO speed.
 - If you press the <★> button and recompose the shot, you can see the exposure level difference on the exposure level indicator (p.22, 23) compared to when the <★> button was pressed.

Selecting the Metering Mode [★]

You can select one of four methods to measure the subject brightness. In Basic Zone modes, evaluative metering is set automatically.

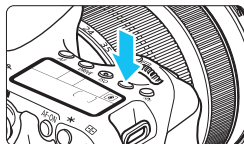





1 Press the <◻> button. (◻6)

2 Select the metering mode.

- While looking at the LCD panel, turn the <◻> or <◻> dial.



- : Evaluative metering
- : Partial metering
- : Spot metering
- : Center-weighted average metering

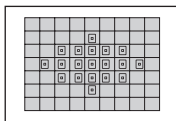

 **Evaluative metering**

This is a general-purpose metering mode suited even for backlit subjects. The camera sets the exposure automatically to suit the scene.



 **Partial metering**

Effective when the background is much brighter than the subject due to backlighting, etc. The metering is weighted at the center covering approx. 7.7% of the viewfinder area.

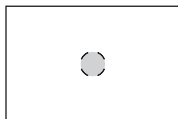







 **Spot metering**

This is for metering a specific spot of the subject or scene. The metering is weighted at the center covering approx. 3.0% of the viewfinder area.



 **Center-weighted average metering**

The metering is weighted at the center and then averaged for the entire scene.

-  ● With  (Evaluative metering), the exposure setting will be locked when you press the shutter button halfway and focus is achieved. In the  (Partial metering),  (Spot metering), and  (Center-weighted average metering) modes, the exposure is set when the photo is taken. (Pressing the shutter button halfway does not lock the exposure.)
- When  is set,  can be displayed in the viewfinder (p.376).

Setting Exposure Compensation [☆]

Exposure compensation can brighten (increased exposure) or darken (decreased exposure) the standard exposure set by the camera. Exposure compensation can be set in the **P/Tv/Av** shooting modes. Although you can set the exposure compensation up to ± 5 stops in 1/3-stop increments, the exposure compensation indicator in the viewfinder and on the LCD panel can only display the setting up to ± 3 stops. If you want to set the exposure compensation setting beyond ± 3 stops, use the Quick Control (p.50) or follow the instructions for [**3: Expo.comp./AEB**] on the next page.



1 Check the exposure level indicator.

- Press the shutter button halfway () and check the exposure level indicator.

Increased exposure for a brighter image



2 Set the exposure compensation amount.

- While looking at the viewfinder or LCD panel, turn the  dial.
- If it cannot be set, set the **<LOCK>** switch downward, then turn the  dial.

Decreased exposure for a darker image





3 Take the picture.

- To cancel the exposure compensation, set the exposure compensation amount back to .

 If [**3: Auto Lighting Optimizer**] (p.140) is set to any setting other than [**Disable**], the image may look bright even if a decreased exposure compensation is set.



- The exposure compensation amount will remain in effect even after you set the power switch to **<OFF>**.
- After setting the exposure compensation amount, you can set the **<LOCK>** switch upward to prevent the exposure compensation amount from changing accidentally.
- If the exposure compensation amount exceeds ± 3 stops, the end of the exposure level indicator will display  or .

Auto Exposure Bracketing (AEB) ☆

By changing the shutter speed or aperture automatically, the camera brackets the exposure up to ± 3 stops in 1/3-stop increments for three successive shots. This is called AEB.

* AEB stands for Auto Exposure Bracketing.

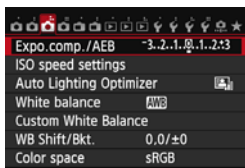

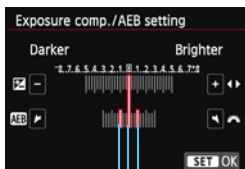

1 Select [Expo.comp./AEB].

- Under the [3] tab, select [Expo.comp./AEB], then press <SET>.



AEB range

2 Set the AEB range.



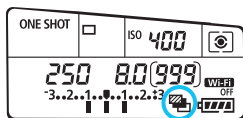





- Turn the < > dial to set the AEB range. Press the <◀▶> key to set the exposure compensation amount.
- Press <SET> to set it.
- ▶ When you exit the menu, < > and the AEB range will be displayed on the LCD panel.



3 Take the picture.

- The three bracketed shots will be taken according to the drive mode set in this sequence: Standard exposure, decreased exposure, and increased exposure.
- AEB will not be automatically canceled. To cancel AEB, follow step 2 to turn off the AEB range display.



- During AEB shooting, <✳> in the viewfinder and < > on the LCD panel will blink.
- If the drive mode is set to < > or < S >, press the shutter button three times for each shot. When < H >, < >, or < S > is set and you hold down the shutter button completely, the three bracketed shots will be taken continuously and the camera will automatically stop shooting. When < > or < 2 > is set, the three bracketed shots will be taken continuously after a 10-sec. or 2-sec. delay.
- You can set AEB in combination with exposure compensation.
- If the AEB range exceeds ± 3 stops, the end of the exposure level indicator will display <◀> or <▶>.
- AEB cannot be used with flash, **[Multi Shot Noise Reduction]**, Creative Filters, or bulb exposures.
- AEB will be canceled automatically when you set the power switch to <OFF> or when the flash is ready to fire.

✳ AE Lock ☆

Use AE lock when the area of focus is to be different from the exposure metering area or when you want to take multiple shots at the same exposure setting. Press the <✳> button to lock the exposure, then recompose and take the shot. This is called AE lock. It is effective for backlit subjects.

1 Focus the subject.

- Press the shutter button halfway.
- ▶ The exposure setting will be displayed.



2 Press the <✳> button. (☉4)



- ▶ The <✳> icon lights up in the viewfinder to indicate that the exposure setting is locked (AE lock).
- Each time you press the <✳> button, the current autoexposure setting is locked.



3 Recompose and take the picture.

- If you want to maintain the AE lock while taking more shots, hold down the <✳> button and press the shutter button to take another shot.

AE Lock Effects

Metering Mode (p.165)	AF Point Selection Method (p.103-105)	
	Automatic Selection	Manual Selection
 *	AE lock is applied at the AF point that achieved focus.	AE lock is applied at the selected AF point.
	AE lock is applied at the center AF point.	

* When the lens' focus mode switch is set to <MF>, AE lock is applied at the center AF point.

 AE lock is not possible with bulb exposures.

B: Bulb Exposures

In this mode, the shutter stays open as long as you hold down the shutter button completely, and closes when you let go of the shutter button. This is called bulb exposure. Use bulb exposures for night scenes, fireworks, astronomical objects, and other subjects requiring long exposures.



1 Set the Mode Dial to .

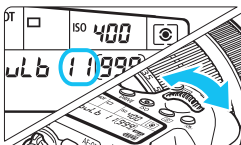

2 Set the desired aperture.

- While looking at the LCD panel, turn the < > or < > dial.



Elapsed exposure time

3 Take the picture.

- The exposure will continue for as long as you keep the shutter button pressed completely.
- ▶ The elapsed exposure time will be displayed on the LCD panel.



- Long exposures produce more noise than usual.
- If Auto ISO is set, the ISO speed will be ISO 400 (p.122).



- When [4: Long exp. noise reduction] is set to [Auto] or [Enable], noise generated by the long exposure can be reduced (p.143).
- For bulb exposures, using a tripod and a remote switch (sold separately, p.184) is recommended.
- You can also use a remote controller (sold separately, p.184) for bulb exposures. When you press the remote controller's transmit button, the bulb exposure will start immediately or 2 sec. later. Press the button again to stop the bulb exposure.

HDR : HDR (High Dynamic Range) Shooting ☆

Highlight detail and shadow detail are retained for a high dynamic range of tones even with high-contrast scenes. HDR shooting is effective for landscape and still-life shots.

With HDR shooting, three images of different exposures (standard exposure, underexposure, and overexposure) are captured for each shot and then merged together automatically. The HDR image is recorded as a JPEG image.

* HDR stands for High Dynamic Range.

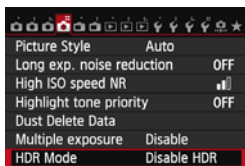

1 Select [HDR Mode].

- Under the [📷4] tab, select [HDR Mode], then press <SET>.

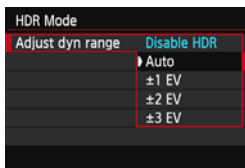

2 Set [Adjust dyn range].

- Select the desired dynamic range setting, then press <SET>.
- Selecting [Auto] will have the dynamic range set automatically depending on the image's overall tonal range.
- The higher the number, the wider the dynamic range will be.
- To exit HDR shooting, select [Disable HDR].

- Only the merged HDR image will be saved. The three images used to produce the merged HDR image will not be saved.
- You cannot select RAW and RAW+JPEG. The HDR mode cannot be set if RAW or RAW+JPEG is set.
- If you set AEB, white balance bracketing, Multi Shot Noise Reduction, multiple exposures or if you shoot bulb exposures or a movie, HDR mode cannot be set.
- The flash will not fire during HDR shooting.

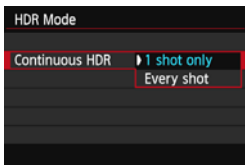

3 Set [Continuous HDR].

- Select either [**1 shot only**] or [**Every shot**], then press <SET>.
- With [**1 shot only**], HDR shooting will be canceled automatically after the shooting ends.
- With [**Every shot**], HDR shooting continues until the setting in step 2 is set to [**Disable HDR**].

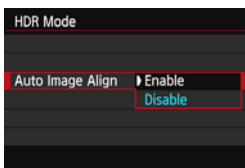

4 Set [Auto Image Align].

- For handheld shooting, select [**Enable**]. When using a tripod, select [**Disable**], then press <SET>.

5 Take the picture.

- HDR shooting is possible with viewfinder shooting and Live View shooting.
- ▶ <HDR> will be displayed on the LCD panel.
- When you press the shutter button completely, three consecutive images will be captured, and the HDR image will be recorded to the card.

- If you shoot a moving subject, the subject's movement may leave afterimages or the surrounding area of the subject may become dark.
- To prevent camera shake, the ISO speed may be set higher than usual.
- HDR shooting is not possible with ISO expansion. (HDR shooting is possible within the range of ISO 100 - ISO 12800.)
- When shooting HDR images with **[Auto Image Align]** set to **[Enable]**, AF point display information (p.294) and Dust Delete Data (p.341) will not be appended to the image.
- If **[Auto Image Align]** is set to **[Enable]** and the HDR picture is shot handheld, the edges of the photos will be cropped, lowering the resolution slightly. Also, if the images cannot be aligned properly due to camera shake, etc., auto image alignment may not take effect. Note that when shooting with excessively bright or dark exposure settings, auto image alignment may not work properly.
- If you perform handheld HDR shooting while **[Auto Image Align]** is set to **[Disable]**, the 3 images may not be properly aligned and the HDR effect may be minimal. In such a case, using a tripod is recommended.
- Auto image alignment may not work properly with repetitive patterns (lattice, stripes, etc.) or flat, single-tone images.
- The color gradation of the sky or white walls may not be reproduced correctly. Irregular colors or noise may appear.
- HDR shooting under fluorescent or LED lighting may result in unnatural color reproduction of the illuminated areas.
- Since HDR shooting merges the images, it will take a longer time to record the HDR image to the card than with normal shooting. During the processing of the images, "buSY" will be displayed in the viewfinder and on the LCD panel and you cannot take another picture until the processing is completed.
- In HDR mode, the options grayed out in the camera menu cannot be set. Note that when you set HDR mode, the Auto Lighting Optimizer, highlight tone priority, and exposure simulation will be set to **[Disable]** before shooting.

Multiple Exposures ☆

You can shoot two to nine exposures to be merged into one image. If you shoot multiple-exposure images with Live View shooting (p.215), you can see how the single exposures merge while shooting.

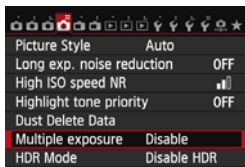

1 Select [Multiple exposure].

- Under the [4] tab, select [Multiple exposure], then press < (SET) >.

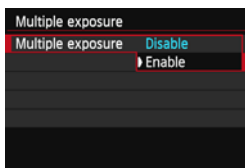

2 Set [Multiple exposure].

- Select [Enable], then press < (SET) >.
- To exit shooting multiple exposures, select [Disable].



- During continuous shooting, the continuous shooting speed will decrease greatly.
- If you set white balance bracketing, Multi Shot Noise Reduction, the HDR mode or if you shoot a movie, multiple-exposure shooting cannot be set.
- If the Wi-Fi function is used, multiple-exposure shooting cannot be set.
- During multiple-exposure shooting, Auto Lighting Optimizer, highlight tone priority, peripheral illumination correction and chromatic aberration correction will be disabled.
- The image-recording quality, ISO speed, Picture Style, high ISO speed noise reduction and color space, etc. set for the first single exposure will also be set for the subsequent exposures.
- If the Picture Style is [Auto], the [Standard] Picture Style will be set for shooting.



3 Set [Multi-expos ctrl].

- Select the desired multiple-exposure control method, then press <SET>.

• Additive

The exposure of each single exposure is added cumulatively. Based on the [No. of exposures], set a negative exposure compensation. Refer to the basic guide below to set a negative exposure compensation.

Exposure Compensation Setting Guide for Multiple Exposures

Two exposures: -1 stop, three exposures: -1.5 stop, four exposures: -2 stops

If [Additive] is set, the image displayed during shooting may look noisy. However, when you finish shooting the set number of exposures, noise reduction will be applied and the final multiple-exposure image will look less noisy.

• Average

Based on the [No. of exposures], negative exposure compensation is set automatically as you shoot multiple exposures. If you shoot multiple exposures of the same scene, the exposure of the subject's background will be automatically controlled to obtain a standard exposure.

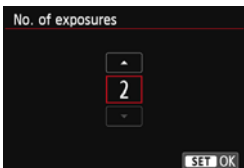

4 Set the [No. of exposures].

- Press the <▲▼> key to select the number of exposures, then press <SET>.
- You can set it from 2 to 9 exposures.

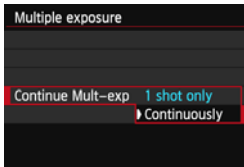

5 Set [Continue Mult-exp].

- Select either [1 shot only] or [Continuously], then press <SET>.
- With [1 shot only], multiple-exposure shooting will be canceled automatically after the shooting ends.
- With [Continuously], multiple-exposure shooting continues until the setting in step 2 is set to [Disable].

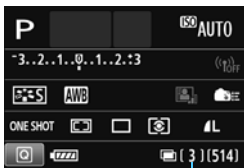

Remaining number of exposures



6 Take the first exposure.

- ▶ The captured image will be displayed.
- ▶ The <[]> icon will blink.
- The number of remaining exposures is displayed in brackets [] in the viewfinder or on the screen.
- Pressing the <[]> button enables you to view the captured image (p.180).

7 Shoot subsequent exposures.

- ▶ Captured images will be displayed overlaid on previous images.
- With Live View shooting, the multiple-exposure images merged so far will be displayed. By pressing the <INFO.> button, you can display only the Live View image.
- After you shoot the set number of exposures, multiple-exposure shooting will exit. With continuous shooting, after you finish shooting the set number of exposures while holding down the shutter button, the shooting will stop.

- Only the merged multiple-exposure image will be saved. The images taken in steps 6 and 7 for the multiple-exposure image will not be saved.
- With multiple exposures, the more exposures there are, the more noticeable the noise, irregular colors, and banding will be. Also, as noise increases with higher ISO speeds, shooting at low ISO speeds is recommended.
- If [**Additive**] is set, the image processing after taking the multiple exposures will take time. (The access lamp will light up for longer than usual.)
- If you perform Live View shooting while [**Additive**] is set, the Live View function will stop automatically when the multiple-exposure shooting ends.
- In step 7, the brightness and noise of the multiple-exposure image displayed during Live View shooting will be different from the final multiple-exposure image recorded.
- If the power switch is set to <OFF>, the battery is replaced, or if you switch to movie shooting after you set multiple exposure settings, multiple-exposure shooting will be canceled.
- If you switch the shooting mode to a Basic Zone mode or <C> while shooting, multiple-exposure shooting will end.
- When multiple exposure is set or while you shoot multiple exposures, you cannot use the functions grayed out in the camera menu.
- If you connect the camera to a computer or printer, multiple-exposure shooting is not possible.

 You can press the <> button to view the multiple exposures taken so far or delete the last single exposure (p.180).

Merging Multiple Exposures with an Image Recorded on the Card

You can select an image recorded on the card as the first single exposure. The original of the selected image will remain intact.

You can only select RAW images. You cannot select M RAW/S RAW or JPEG images.

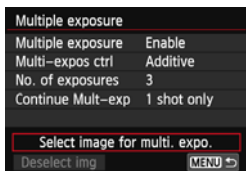

1 Select [Select image for multi. expo.].

- Select [**Select image for multi. expo.**], then press < (SET) >.
- ▶ The images on the card will be displayed.

2 Select an image.

- Turn the < (DISP) > dial to select the image to be used as the first single exposure, then press < (SET) >.
- Select [**OK**].
- ▶ The file number of the selected image will be displayed at the bottom of the screen.

3 Take the picture.

- When you select the first image, the number of remaining exposures as set with [**No. of exposures**] will decrease by 1. For example, if [**No. of exposures**] is 3, you can shoot two exposures.



- Images shot with highlight tone priority set to [**Enable**] and images whose aspect ratio is not 3:2 (p.229) cannot be selected as the first single exposure.
- Auto Lighting Optimizer, peripheral illumination correction and chromatic aberration correction will be disabled, regardless of the settings of the RAW image selected as the first single exposure.
- The ISO speed, Picture Style, high ISO speed noise reduction, and color space, etc. set for the first RAW image will also be set for the subsequent images.
- If the first RAW image's Picture Style is [**Auto**], the [**Standard**] Picture Style will be set for the subsequent images.
- You cannot select an image taken with another camera.

- You can also select a **RAW** multiple-exposure image as the first single exposure.
- If you select [**Deselect img**], the selected image will be canceled.

Checking and Deleting Multiple Exposures During Shooting

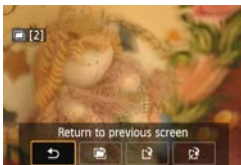

Before you finish shooting the set number of exposures, you can press the <▶> button to view the merged multiple-exposure image so far. You can check how it looks and the exposure. If you press the <⏏> button, the operations possible during multiple-exposure shooting will be displayed.

Operation	Description
↶ Return to previous screen	The operations will disappear and the screen before you pressed the <⏏> button will reappear.
🗑 Undo last image	Deletes the last image you shot (shoot another image). The number of remaining exposures will increase by 1.
✔ Save and exit	The images shot so far will be merged and saved as a multiple-exposure image.
✖ Exit without saving	Multiple-exposure shooting will exit without saving the images shot.

- During multiple-exposure shooting, you can only play back multiple-exposure images.

? FAQ

● Are there any restrictions on the image-recording quality?

All JPEG image-recording quality settings can be selected. If **M RAW** or **S RAW** is set, the merged multiple-exposure will be a **RAW** image.

Image-Recording Quality Setting	Merged Multiple-Exposure
JPEG	JPEG
RAW	RAW
M RAW/S RAW	RAW
RAW+JPEG	RAW+JPEG
M RAW/S RAW+JPEG	RAW+JPEG

● Can I merge images recorded on the card?

With [Select image for multi. expo.], you can select the first single exposure from the images recorded on the card (p.179). Note that you cannot merge multiple images already recorded on the card.

● Are multiple exposures possible with Live View shooting?

Shooting multiple exposures is also possible with Live View shooting (p.215). Note that [1: Aspect ratio] will be fixed at [3:2].

● Will auto power off take effect during multiple-exposure shooting?

As long as [2: Auto power off] is not set to [Disable], the power will turn off automatically after 30 min. of non-operation. If the auto power off takes effect, multiple-exposure shooting will end, and multiple-exposure settings will be canceled.

Before starting the multiple-exposure shooting, the auto power off will take effect as set with the camera, and multiple-exposure settings will be canceled.

Mirror Lockup [☆]

Although using the self-timer or a remote switch can prevent camera shake, using mirror lockup to prevent camera vibrations (mirror shock) can also help when you use a super telephoto lens or shoot close ups (macro photography).

1 Set [Mirror lockup] to [Enable].

- Under the [M2] tab, select [Mirror lockup], then press < (SET) >.
- Select [Enable], then press < (SET) >.

2 Focus the subject, then press the shutter button completely.

- ▶ The mirror will swing up.

3 Press the shutter button completely again.

- ▶ The picture is taken and the mirror goes back down.

- In very bright light, such as at the beach or a ski slope on a sunny day, take the picture promptly after mirror lockup.
- Do not point the camera toward the sun. The sun's heat can scorch and damage the shutter curtains.
- If you use the self-timer and bulb exposure in combination with a mirror lockup, keep pressing the shutter button completely (self-timer delay time + bulb exposure time). If you let go of the shutter button during the self-timer countdown, there will be a shutter-release sound, but no picture will be taken.
- During mirror lockup, shooting function settings and menu operations, etc. are disabled.

- Even if the drive mode is set to continuous shooting, only one shot can be taken.
- You can also use the self-timer with mirror lockup.
- If 30 seconds elapse after the mirror has locked up, it will go back down automatically. Pressing the shutter button completely again locks up the mirror again.
- For mirror lockup, using Remote Switch RS-60E3 (sold separately) is recommended (p.184).
- You can also use a remote controller (sold separately, p.184). Setting the remote controller to a 2-sec. delay is recommended.

Using the Eyepiece Cover

When you use the self-timer, bulb, or a remote switch and do not look through the viewfinder, stray light entering the viewfinder can cause the image to look dark. To prevent this, use the eyepiece cover (p.27) attached to the camera strap.

During Live View shooting and movie shooting, attaching the eyepiece cover is unnecessary.

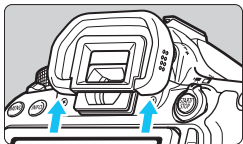

1 Detach the eyecup.

- Push the bottom of the eyecup to detach.

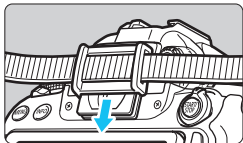

2 Attach the eyepiece cover.

- Slide the eyepiece cover down into the eyepiece groove to attach it.
- After you finish shooting, detach the eyepiece cover and attach the eyecup.

Using a Remote Switch

You can connect Remote Switch RS-60E3 (sold separately) to the camera and shoot (p.416).

For detailed instructions, refer to the remote switch's instruction manual.

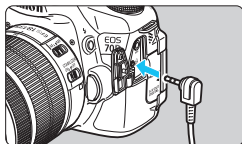

- 1 **Open the terminal cover.**
- 2 **Connect the plug to the remote control terminal.**

Remote Control Shooting



With Remote Controller RC-6 (sold separately), you can shoot remotely up to approx. 5 meters/16.4 feet from the camera. You can either shoot immediately or use a 2-sec. delay.

You can also use Remote Controller RC-1 and RC-5.

- 1 **Focus the subject.**
- 2 **Set the lens focus mode switch to <MF>.**
 - You can also shoot with <AF>.
- 3 **Press the <DRIVE> button. (ⓘ6)**

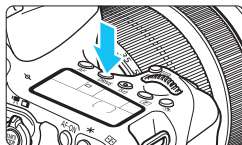



4 Select the self-timer.

- Look at the LCD panel and turn the dial to select or .

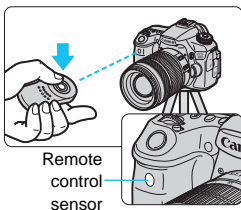

5 Press the remote controller's transmit button.

- Point the remote controller toward the camera's remote control sensor and press the transmit button.
- ▶ The self-timer lamp lights up and the picture is taken.



- Fluorescent or LED lighting may cause camera misoperation by triggering the shutter inadvertently. Try to keep the camera away from such light sources.
- If you point a remote controller for a TV set toward the camera and operate it, it may cause camera misoperation by triggering the shutter inadvertently.



Remote control shooting is also possible with devices such as an EX-series Speedlite equipped with a remote-release function.

6

Flash Photography

This chapter explains how to use the built-in flash and external Speedlites (EX-series, sold separately), how to set flash settings with the menu, and how to use the built-in flash for wireless flash shooting.

 Flash cannot be used with movie shooting. (It will not fire.)

⚡ Using the Built-in Flash

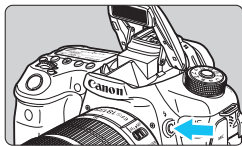

In Creative Zone modes, just press the <⚡> button to raise the built-in flash for flash photography. To retract the built-in flash, push it back down with your fingers. In Basic Zone modes (except <📷> <📷> <📷> <📷> <📷> modes), the built-in flash will

be raised and fire automatically in low-light and backlit conditions.

In the <A+> <CA> <📷> <📷> <📷> modes, you have the option to fire the flash or not.

The table below shows the shutter speed and aperture settings that will be used with flash.

Shooting Mode	Shutter Speed	Aperture
A+ CA 📷 📷 📷 📷	Automatically set	Automatically set
P	Automatically set (1/250 sec. - 1/60 sec.)	Automatically set
Tv	Manually set (1/250 sec. - 30 sec.)	Automatically set
Av	Automatically set (1/250 sec. - 30 sec.)	Manually set
M	Manually set (1/250 sec. - 30 sec.)	Manually set
B	The exposure will continue while you hold down the shutter button.	Manually set



Flash Photography in the <Av> Mode

To obtain a correct flash exposure, the flash output will be set automatically (autoflash exposure) to match the manually-set aperture. The shutter speed will be set automatically between 1/250 sec. - 30 sec. to suit the scene's brightness.

In low light, the main subject is exposed with the automatic flash, and the background is exposed with a slow shutter speed set automatically. Both the subject and background look properly exposed (automatic slow-speed flash sync). If you are handholding the camera, keep it steady to prevent camera shake. Using a tripod is recommended.

To prevent a slow shutter speed, under [📷2: Flash control], set [Flash sync. speed in Av mode] to [1/250-1/60 sec. auto] or [1/250 sec. (fixed)] (p.196).

Effective Range of Built-in Flash

[Approx. in meters/feet]

ISO Speed	EF-S18-55mm f/3.5-5.6 IS STM EF-S18-135mm f/3.5-5.6 IS STM EF-S18-200mm f/3.5-5.6 IS	
	Wide Angle: f/3.5	Telephoto: f/5.6
100	1-3.4/3.3-11.2	1-2.1/3.3-7.0
200	1-4.8/3.3-15.9	1-3.0/3.3-9.9
400	1-6.9/3.3-22.5	1-4.3/3.3-14.1
800	1.2-9.7/4.0-31.8	1-6.1/3.3-19.9
1600	1.7-13.7/5.6-45.0	1.1-8.6/3.5-28.1
3200	2.4-19.4/8.0-63.6	1.5-12.1/5.0-39.8
6400	3.4-27.4/11.2-90.0	2.1-17.1/7.0-56.2
12800	4.8-38.8/15.9-127.3	3.0-24.2/9.9-79.5
H (25600)	6.9-54.9/22.5-180.0	4.3-34.3/14.1-112.5



- When you use the built-in flash, detach any lens hood and keep at least 1 meter/3.3 feet away from the subject.
- If the lens has a hood attached or if you are too close to the subject, the bottom of the picture might look dark due to the obstructed flash.





If you use a super telephoto lens or large-aperture lens and the bottom of the picture looks dark, using an external Speedlite (sold separately, p.193) is recommended.

MENU Red-eye Reduction

Using the red-eye reduction lamp before flash photography can reduce red eye.

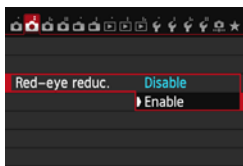
Red-eye reduction will function in any shooting mode except , , and .



- 1 **Select [Red-eye reduc.].**
 - Under the [2] tab, select [**Red-eye reduc.**], then press .
- 2 **Select [Enable].**
 - Select [**Enable**], then press .
 - For flash photography, when you press the shutter button halfway, the red-eye reduction lamp will light up.

- The red-eye reduction feature is most effective when the subject looks at the red-eye reduction lamp, when the room is well lit, or when you are close to the subject.
- When you press the shutter button halfway, the scale display on the bottom of the viewfinder will shrink and turn off. For best results, take the picture after this scale display turns off.
- The effectiveness of red-eye reduction varies depending on the subject.



Flash Exposure Compensation ☆

Set flash exposure compensation if the flash exposure of the subject does not come out as desired. You can set flash exposure compensation up to ± 3 stops in 1/3-stop increments.

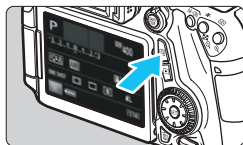

- 1 **Press the button. (10)**
 - ▶ The Quick Control screen will appear.



2 Select [].

- Press the <▲▼> <◀▶> keys to select [*], then press <SET>.
- ▶ The flash exposure compensation screen will appear.



3 Set the exposure compensation amount.

- To make the flash exposure brighter, turn the <☉> or <⚙️> dial to the right (increased exposure). To make it darker, turn the <☉> or <⚙️> dial to the left (decreased exposure).
- ▶ When you press the shutter button halfway, the <⚡> icon will appear in the viewfinder.
- After taking the picture, follow steps 1 to 3 and set the flash exposure compensation amount to 0.



- If [3: Auto Lighting Optimizer] (p.140) is set to any setting other than [Disable], the image may look bright even if a decreased flash exposure compensation is set.
- If flash exposure compensation is set with an external Speedlite (sold separately, p.193), you cannot set the flash exposure compensation with the camera (Quick Control or External flash function settings). If it is set with both the camera and Speedlite, the Speedlite's setting overrides the camera's.



- The exposure compensation amount will remain in effect even after you set the power switch to <OFF>.
- You can also set flash exposure compensation with [Built-in flash settings] in [2: Flash control] (p.195).
- The camera can also be used to set the external Speedlite's flash exposure compensation in the same way as with the built-in flash.

✳ FE Lock ✳

FE (flash exposure) lock obtains and locks the appropriate flash exposure for the desired part of the subject as framed.

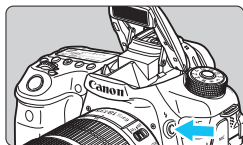

1 Press the <⚡> button.

- ▶ The built-in flash will rise.
- Press the shutter button halfway and look in the viewfinder to check that the <⚡> icon is lit.



2 Focus the subject.



3 Press the <✳> button. (ⓘ16)

- Aim the viewfinder center over the subject where you want to lock the flash exposure, then press the <✳> button.
- ▶ The flash will fire a preflash and the required flash output is calculated and retained in memory.
- ▶ In the viewfinder, “FEL” is displayed for a moment and <⚡*> will light up.
- Each time you press the <✳> button, a preflash is fired and the required flash output is calculated and retained in memory.



4 Take the picture.

- Compose the shot and press the shutter button completely.
- ▶ The flash is fired when the picture is taken.



- If the subject is too far away and beyond the effective range of the flash, the <⚡> icon will blink. Move closer to the subject and repeat steps 2 to 4.
- FE lock is not possible with Live View shooting.

⚡ Using an External Speedlite

EOS-dedicated, EX-series Speedlites

Flash photography with EX-series Speedlite (sold separately) is as easy as with built-in flash.

For detailed instructions, refer to the EX-series Speedlite's instruction manual. This camera is a Type-A camera that can use all the features of EX-series Speedlites.

To set the flash functions and flash Custom Functions with the camera's menu, see pages 195-202.



Shoe-mount Speedlites



Macro Lites

- **Flash exposure compensation**

Set it with the Quick Control screen (p.50) or **[External flash func. setting]** under **[CAMERA 2: Flash control]** (p.199). With the Quick Control screen, you can set flash exposure compensation in the same way as for the built-in flash. See page 190.

- **FE lock**

Set this in the same way as for the built-in flash. See steps 2 to 4 on the preceding page.



When it is difficult to achieve focus with autofocus, the EOS-dedicated, external Speedlite will automatically emit the AF-assist beam when necessary.

Canon Speedlites Other Than the EX-series

- With an EZ/E/EG/ML/TL-series Speedlite set to A-TTL or TTL autoflash mode, the flash can be fired at full output only. Set the camera's shooting mode to <M> (manual exposure) or <Av> (aperture-priority AE) and adjust the aperture setting before shooting.
- When using a Speedlite that has manual flash mode, shoot in the manual flash mode.

Using Non-Canon Flash Units

Sync Speed

The camera can synchronize with non-Canon compact flash units at 1/250 sec. and slower speeds. With large studio flash units, be sure to test the flash synchronization before shooting with the sync speed set within approx. 1/60 sec. to 1/30 sec., since the flash duration of such units is longer than that of compact flash units and vary depending on the models.

Cautions for Live View Shooting

If you use a non-Canon flash unit with Live View shooting, set [ 2: Silent LV shoot.] to [Disable] (p.231). The flash will not fire if it is set to [Mode 1] or [Mode 2].

- ⓘ ● If the camera is used with a flash unit or flash accessory dedicated to another camera brand, the camera may not operate properly and malfunction may result.
- Do not attach a high-voltage flash unit on the camera's hot shoe. It may not fire.

MENU Setting the Flash ☆

With the built-in flash or an EX-series Speedlite compatible with flash function settings, you can use the camera's menu screen to set flash functions and the external Speedlite's Custom Functions. **If you use an external Speedlite, attach the Speedlite to the camera and turn on the Speedlite before setting the flash functions.**

For details on the external Speedlite's flash functions, refer to the Speedlite's instruction manual.

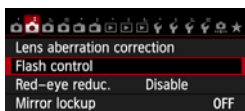

1 Select [Flash control].

- Under the [**2**] tab, select [**Flash control**], then press <SET>.
- ▶ The Flash control screen will appear.

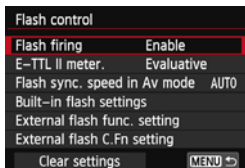

2 Select the desired option.

- Select the option to be set, then press <SET>.

Flash Firing

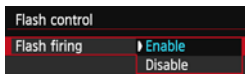

To enable flash photography, set [**Enable**]. To enable only the AF-assist beam, set [**Disable**].

E-TTL II Flash Metering



For normal flash exposures, set it to [**Evaluative**]. If [**Average**] is set, the flash exposure will be averaged for the entire metered scene. Flash exposure compensation may be necessary. This setting is for advanced users.

Flash Synchronization Speed in Av Mode

Flash sync. speed in Av mode	
Auto	AUTO
1/250-1/60sec. auto	1/250 -1/60 A
1/250 sec. (fixed)	1/250

INFO Help SET OK

You can set the flash sync speed for flash photography in the aperture-priority AE (**Av**) mode.

- **AUTO: Auto**

The flash sync speed is set automatically within a range of 1/250 sec. to 30 sec. to suit the scene's brightness. High-speed sync is also possible.

- ^{1/250}/_{-1/60} A: **1/250-1/60 sec. auto**

Prevents a slow shutter speed from being set in low-light conditions. It is effective for preventing subject blur and camera shake. However, while the subject will be properly exposed with the flash, the background may come out dark.

- 1/250: **1/250 sec. (fixed)**

The flash sync speed is fixed at 1/250 sec. This more effectively prevents subject blur and camera shake than with [**1/250-1/60sec. auto**]. However, in low light, the subject's background will come out darker than with [**1/250-1/60sec. auto**].

ⓘ If [**1/250-1/60sec. auto**] or [**1/250 sec. (fixed)**] is set, high-speed sync is not possible in the <**Av**> mode with the external Speedlite.

Built-in Flash Settings

● Flash mode

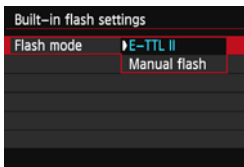

Normally, set this to **[E-TTL II]**. This enables autoexposure shooting with the built-in flash.

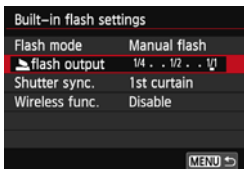

To set the flash output level manually, select **[Manual flash]**.
Select **[flash output]**, then set the flash output level to within 1/1 - 1/128 (1/3-stop increments) before shooting.

● Shutter synchronization

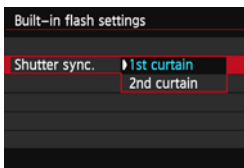

Normally, set this to **[1st curtain]** so that the flash fires immediately after the exposure starts.

If **[2nd curtain]** is set, the flash will fire right before the shutter closes. When this is combined with a slow shutter speed, you can create a trail of light such as from car headlights at night. With second-curtain synchronization, two flashes will be fired: once when you press the shutter button completely, and once immediately before the exposure ends.

 When using second-curtain synchronization, set the shutter speed to 1/25 sec. or slower. If the shutter speed is 1/30 sec. or faster, first-curtain synchronization will be used automatically even if **[2nd curtain]** is set.

● **Flash exposure compensation**



The same setting as step 3 in “Flash Exposure Compensation” on page 190 can be set.

● **Wireless functions**

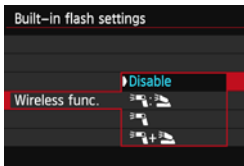

With wireless flash photography (via optical transmission), you can use the built-in flash to control an external Speedlite. For details, see “Using Wireless Flash” on page 203.

External Flash Function Settings

The screen display and setting options will differ depending on the external Speedlite model, current flash mode, Speedlite's Custom Function settings, etc.

For details on your Speedlite's flash functions, refer to the Speedlite's instruction manual.

Sample display

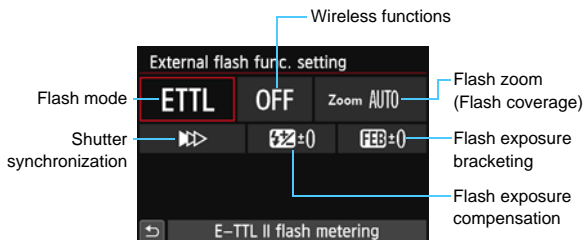

Flash mode

You can select the flash mode to suit your desired flash shooting.



[E-TTL II flash metering] is the standard mode of EX-series Speedlites for automatic flash shooting.

The [Manual flash] mode is for setting the Speedlite's [Flash output level] yourself.

Regarding other flash modes, refer to the instruction manual of a Speedlite compatible with the functions.

● Wireless functions

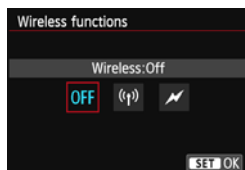

Wireless (multiple) flash shooting is possible with radio or optical transmission. For details on wireless flash, refer to the instruction manual of a Speedlite compatible with the wireless flash shooting.

● Flash zoom (Flash coverage)

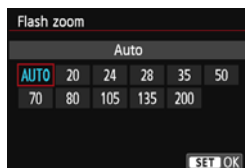

With Speedlites having a zooming flash head, you can set the flash coverage. Normally, set this to **[AUTO]** so that the camera will automatically set the flash coverage to match the lens focal length.

● Shutter synchronization

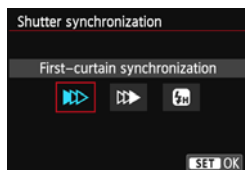

Normally, set this to **[First-curtain synchronization]** so that the flash fires immediately after the exposure starts.

If **[Second-curtain synchronization]** is set, the flash will fire right before the shutter closes. When this is combined with a slow shutter speed, you can create a trail of light such as from car headlights at night. With second-curtain synchronization, two flashes will be fired: once when you press the shutter button completely, and once immediately before the exposure ends.

If **[High-speed synchronization]** is set, the flash can be used at all shutter speeds. This is especially effective for portraits using fill flash when you want to give priority to the aperture setting.

● Flash exposure compensation

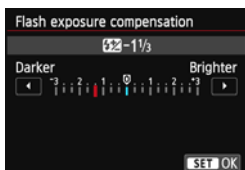

The same setting as step 3 in “Flash Exposure Compensation” on page 190 can be set.

For details, refer to the Speedlite’s instruction manual.

● Flash exposure bracketing

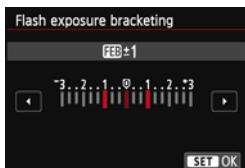

While the flash output is changed automatically, three shots are taken.

For details, refer to the instruction manual of a Speedlite compatible with flash exposure bracketing.



When using second-curtain synchronization, set the shutter speed to 1/25 sec. or slower. If the shutter speed is 1/30 sec. or faster, first-curtain synchronization will be applied automatically even if [**Second-curtain synchronization**] is set.



- With an EX-series Speedlite not compatible with flash function settings, you can only set the following: [**Flash firing**], [**E-TTL II meter.**], and [**Flash exposure compensation**] under [**External flash func. setting**]. ([**Shutter synchronization**] can also be set with certain EX-series Speedlites.)
- If flash exposure compensation is set with an external Speedlite, you cannot set the flash exposure compensation with the camera (Quick Control or External flash function settings). If it is set with both the camera and external Speedlite, the Speedlite’s setting overrides the camera’s.

External Speedlite Custom Function Settings

For details on the external Speedlite's Custom Functions, refer to the Speedlite's instruction manual.

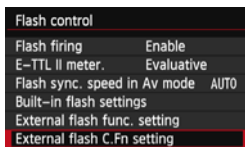

1 Select [External flash C.Fn setting].

- Select [External flash C.Fn setting], then press <SET>.

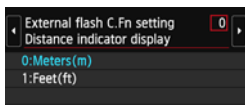

2 Set the desired function.

- Press the <◀▶> key to select the number, then press <SET>.
- Select the setting, then press <SET>.

Clear Settings

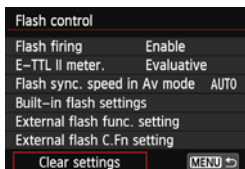

1 Select [Clear settings].

- Select [Clear settings], then press <SET>.

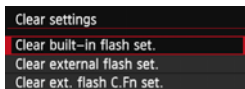

2 Select the settings to be cleared.

- Select [Clear built-in flash set.], [Clear external flash set.], or [Clear ext. flash C.Fn set.], then press <SET>.
- When you select [OK], the respective flash settings or all the Custom Function settings will be cleared.

⚠ With an EX-series Speedlite, if the [Flash metering mode] Custom Function is set to [TTL] (autoflash), the Speedlite will always fire at full output.

🔧 The Speedlite's Personal Functions (P.Fn) cannot be set or canceled with the camera's [Flash control] screen. Set it with the Speedlite.

Using Wireless Flash ☆

The camera's built-in flash can work as a master unit with Canon Speedlites with a wireless slave feature via optical transmission and wirelessly trigger the Speedlite(s) to fire.

Be sure to read about wireless flash photography (optical transmission) in the Speedlite's instruction manual.

Slave Unit Settings and Position

Regarding your Speedlite (slave unit), refer to its instruction manual and set it as follows. The settings other than the ones below for the slave unit's control are all set with the camera. Different types of Canon Speedlite slave units can be used and controlled together.

- (1) Set the external Speedlite as a slave unit.
- (2) Set the external Speedlite's transmission channel to the same channel as set on the camera.*¹
- (3) If you want to set the flash ratio (p.210), set the slave unit ID.
- (4) Position the camera and slave unit(s) within the range shown below.
- (5) Face the slave unit's wireless sensor toward the camera.*²

Example of Wireless Flash Set-up

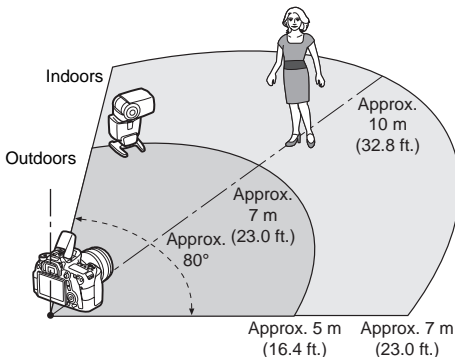

- *1: If the Speedlite does not have a transmission channel setting function, the camera can work with any channel.
- *2: In small rooms, the slave unit may work even if its wireless sensor does not face the camera. The camera's wireless signals can bounce off the walls and be received by the slave unit. When using an EX-series Speedlite with fixed flash head and wireless sensor, take pictures to make sure it can fire.

● **Canceling the slave unit's auto power off**

To cancel the slave unit's auto power off, press the camera's <✳> button. If you are using manual flash firing, press the slave unit's test firing button to cancel the auto power off.

 The camera's master unit function cannot be used for wireless flash shooting with radio transmission.

Wireless Flash Shooting Configurations

The table below shows the possible configurations for wireless flash shooting. Choose the configuration suiting the subject, shooting conditions, and the number of external Speedlites you use.

	External Speedlite		Built-in Flash	Page	Setting	
	Quantity	A:B Flash Ratio			Wireless Functions	Firing Group
Fully Automatic (E-TTL II autoflash)	Single	-	-	p.206		All
	Single	-	Used	p.208	:	-
	Multiple	-	-	p.209		All
	Multiple	Set	-	p.210		(A:B)
	Multiple	-	Used	p.211	+	All and
	Multiple	Set	Used		+	(A:B)
	• Flash exposure compensation				p.212	
• FE lock						

	External Speedlite		Built-in Flash	Page	Setting	
	Quantity	A:B Flash Ratio			Wireless Functions	Firing Group
Manual Flash	Single/ Multiple	-	-	p.213		All
	Multiple	Set	-			(A:B)
	Single/ Multiple	-	Used		+	All and
	Multiple	Set	Used		+	(A:B)

Even if you disable the built-in flash from firing, it will still fire to control the slave unit. The flash fired to control the slave unit may therefore appear in the picture depending on the shooting conditions.

Fully Automatic Shooting with One External Speedlite

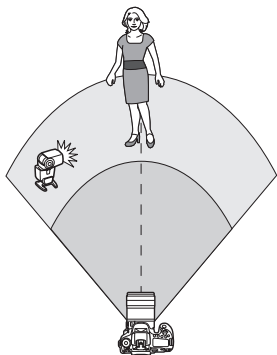

This shows the most basic setup for fully-automatic wireless flash shooting with one external Speedlite.

Steps 1 to 4 and 6 apply to all wireless flash shooting. Therefore, these steps are omitted in the other wireless flash setups explained on the pages hereafter.

On the menu screens, the and icons refer to the external Speedlite, and the and icons refer to the built-in flash.

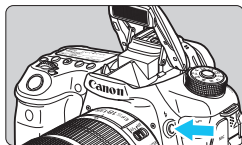

1 Press the button to raise the built-in flash.

- For wireless flash shooting, be sure to raise the built-in flash.

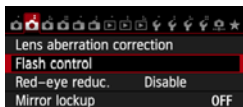

2 Select [Flash control].

- Under the [2] tab, select [Flash control].

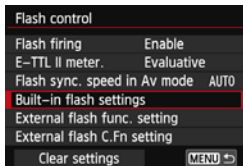

3 Select [Built-in flash settings].

- Select [Built-in flash settings].

Built-in flash settings	
Flash mode	E-TTL II
Shutter sync.	1st curtain
exp. comp.	-3.2.1.0.1.2:3

4 Set [Flash mode: E-TTL II].

- Set [Flash mode] to [E-TTL II].

Built-in flash settings	
Flash mode	E-TTL II
Shutter sync.	1st curtain
Wireless func.	
Channel	1
Firing group	All
exp. comp.	-3.2.1.0.1.2:3

5 Set [Wireless func.:].

- Set [Wireless func.] to [].

Built-in flash settings	
Flash mode	E-TTL II
Shutter sync.	1st curtain
Wireless func.	
Channel	1
Firing group	All
exp. comp.	-3.2.1.0.1.2:3

6 Set [Channel].

- Set the channel (1-4) to the same one as the slave unit.

Built-in flash settings	
Flash mode	E-TTL II
Shutter sync.	1st curtain
Wireless func.	
Channel	1
Firing group	All
exp. comp.	-3.2.1.0.1.2:3

7 Set [Firing group: All].

- Set [Firing group] to [All].

8 Take the picture.

- Set the camera and take the picture in the same way as with normal flash shooting.
- To terminate wireless flash shooting, set [Wireless func.] to [Disable].



- Setting [E-TTL II meter.] to [Evaluative] is recommended.
- Firing a test flash is not possible with the slave unit.

Fully Automatic Shooting with One External Speedlite and the Built-in Flash

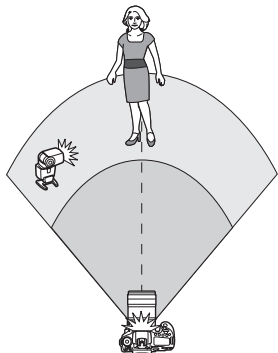

This is fully automatic wireless flash shooting with one external Speedlite and the built-in flash.

You can change the flash ratio between the external Speedlite and built-in flash to adjust how the shadows look on the subject.

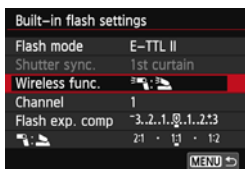

1 Set [Wireless func.] to [Wireless func. icon].

- In step 5 on page 207, set [Wireless func.] to [Wireless func. icon].

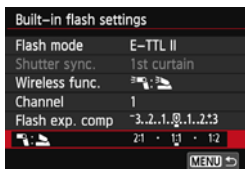

2 Set the desired flash ratio and take the picture.

- Select [Flash ratio icon] and set the flash ratio within 8:1 to 1:1. Setting a flash ratio to the right of 1:1 is not possible.

- If the built-in flash output is not enough, set a higher ISO speed (p.120).
- The 8:1 to 1:1 flash ratio is equivalent to 3:1 to 1:1 stops (1/2-stop increments).

Fully Automatic Shooting with Multiple External Speedlites

Multiple Speedlite slave units can be treated as one flash unit or separated into slave groups whose flash ratio can be set.

The basic settings are shown below. By changing the **[Firing group]** setting, you can shoot with various wireless flash setups with multiple Speedlites.

Built-in flash settings	
Flash mode	E-TTL II
Shutter sync.	1st curtain
Wireless func.	
Channel	1
Firing group	All
exp. comp.	-3.2.1.0.1.2*3

Basic settings:

Flash mode : E-TTL II

Wireless func. :

Channel : (Same as slave units)

● [All] Using multiple slave Speedlites as one flash unit

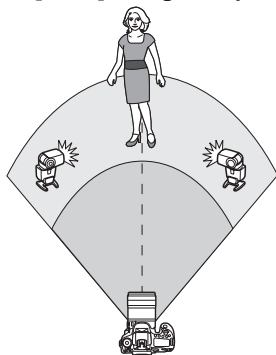

This is convenient when you need a large flash output. All the slave units will fire at the same output and be controlled to obtain a standard exposure.

No matter what the slave ID is (A, B, or C), all the slave units will fire as one group.

Built-in flash settings	
Flash mode	E-TTL II
Shutter sync.	1st curtain
Wireless func.	
Channel	1
Firing group	All
exp. comp.	-3.2.1.0.1.2*3

1 Set [Firing group: All].

2 Take the picture.

- **[ (A:B)] Multiple slave units in multiple groups**

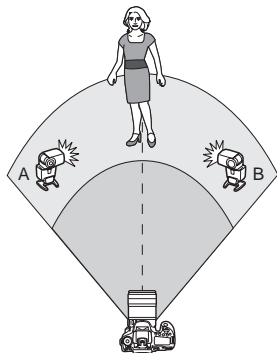

Divide the slave units into Groups A and B and change the flash ratio to obtain the desired lighting effect.

Refer to your Speedlite's instruction manual to set one slave unit's slave ID to A (Group A) and the other slave unit's ID to B (Group B) and position them as shown in the illustration.

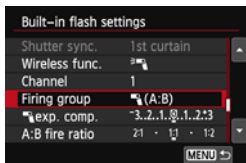

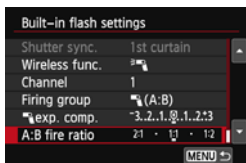

1 Set [Firing group] to [ (A:B)].



2 Set the desired flash ratio and take the picture.

- Select [A:B fire ratio] and set the flash ratio.

! If [Firing group] is set to [ (A:B)], Speedlites with slave ID:C (Group C) will not fire.

 The 8:1 to 1:1 to 1:8 flash ratio is equivalent to 3:1 to 1:1 to 1:3 stops (1/2-stop increments).

Fully Automatic Shooting with the Built-in Flash and Multiple External Speedlites

The built-in flash can also be added to wireless flash shooting explained on pages 209-210.

The basic settings are shown below. By changing the [**Firing group**] setting, you can shoot with various wireless flash setups of multiple Speedlites complemented with the built-in flash.

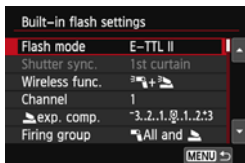

1 Basic settings:

Flash mode : E-TTL II

Wireless func. : [Wireless icon]

Channel : (Same as slave units)

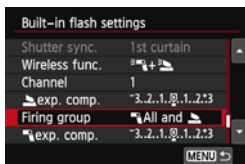

2 Set [Firing group].

- Select [**All and**] or [**(A:B)**].
- With [**(A:B)**], set the A:B flash ratio and shoot.

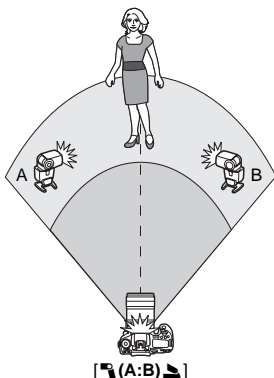
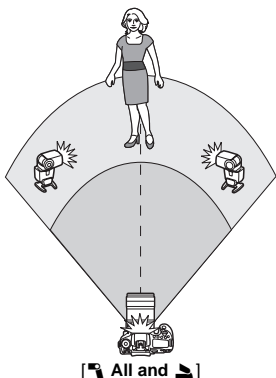

Creative Wireless Flash Shooting

● Flash exposure compensation

When **[Flash mode]** is set to **[E-TTL II]**, flash exposure compensation can be set. The flash exposure compensation settings that can be set (see below) will differ depending on the **[Wireless func.]** and **[Firing group]** settings.

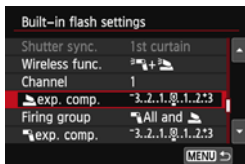

Flash exposure compensation

- The flash exposure compensation is applied to the built-in flash and all the external Speedlites.
- **exp. comp.**
- The flash exposure compensation is applied to the built-in flash.
- **exp. comp.**
- The flash exposure compensation is applied to all the external Speedlites.

● FE lock

If **[Flash mode]** is set to **[E-TTL II]**, you can press the **< * >** button to perform FE lock (p.192).

Setting the Flash Output Manually for Wireless Flash Shooting

When **[Flash mode]** is set to **[Manual flash]**, flash exposure can be set manually. The flash output settings that can be set (**[Flash output]**, **[Group A output]**, etc.) will differ depending on the **[Wireless func.]** setting (see below).

Built-in flash settings	
Flash mode	Manual flash
Shutter sync.	1st curtain
Wireless func.	
Channel	1
Firing group	All
flash output	1/4 . . 1/2 . . 1/1

Wireless func.:

- **Firing group: All**
The manual flash output setting will be applied to all the external Speedlites.
- **Firing group: (A:B)**
You can divide the slave units into Groups A and B and set the flash output separately for each group.

Wireless func.: +

- **Firing group: All and**
You can set the flash output separately for the external Speedlite(s) and built-in flash.
- **Firing group: (A:B)**
You can divide the slave units into Groups A and B and set the flash output separately for each group. You can also set the flash output for the built-in flash.

7

Shooting with the LCD Monitor (Live View Shooting)

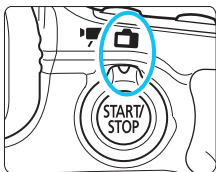

You can shoot while viewing the picture on the camera's LCD monitor. This is called "Live View shooting".

Live View shooting is enabled by setting the Live View shooting/Movie shooting switch to .

- If you handhold the camera and shoot while viewing the LCD monitor, camera shake can cause blurred images. Using a tripod is recommended.
- To shoot while handholding the camera, see page 76.



Remote Live View Shooting

With EOS Utility (provided software, p.456) installed in your computer, you can connect the camera to the computer and shoot remotely while viewing the computer screen. For details, refer to the Software Instruction Manual (p.459) on the CD-ROM.

Shooting with the LCD Monitor

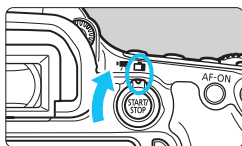

- 1 Set the Live View shooting/Movie shooting switch to .



- 2 Display the Live View image.

- Press the  button.
- ▶ The Live View image will appear on the LCD monitor.
- The Live View image will closely reflect the brightness level of the actual image you capture.



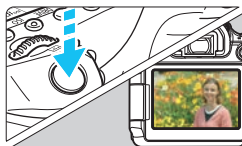

- 3 Focus the subject.

- When you press the shutter button halfway, the camera will focus with the current AF method (p.233).



- 4 Take the picture.

- Press the shutter button completely.
- ▶ The picture will be taken and the captured image is displayed on the LCD monitor.
- ▶ After the image review ends, the camera will return to Live View shooting automatically.
- Press the  button to exit Live View shooting.

-  ● The image's field of view is approx. 99% (with the image-recording quality set to JPEG ).
- In Creative Zone modes, you can check the depth of field by pressing the depth-of-field preview button.
 - During continuous shooting, the exposure set for the first shot will also be applied to subsequent shots.
 - You can also use a remote controller (sold separately, p.184) for Live View shooting.

Enabling Live View Shooting

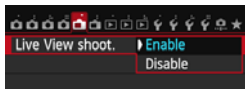

Set [**1**: Live View shoot.] to [Enable].

Number of Possible Shots with Live View Shooting

[Approx. number of shots]

Temperature	Room Temperature (23°C / 73°F)	Low Temperatures (0°C / 32°F)
No Flash	230	210
50% Flash Use	210	200

- The figures above are based on a fully-charged Battery Pack LP-E6 and CIPA (Camera & Imaging Products Association) testing standards.
- With a fully-charged Battery Pack LP-E6, continuous Live View shooting is possible for approx. 1 hr. 50 min. at room temperature (23°C / 73°F).



- In the <P> and <S> modes, the shooting area will be smaller.
- Do not point the camera toward an intense light source, such as the sun on a sunny day or an intense artificial light source. Doing so may damage the image sensor or the camera's internal components.
- **Cautions for using Live View shooting are on pages 249-250.**



- You can also focus by pressing the <AF-ON> button.
- When flash is used, there will be two shutter sounds, but only one shot will be taken. Also, the time it takes to take the picture after you press the shutter button completely will be slightly longer than with viewfinder shooting.
- If the camera is not operated for a prolonged period, the power will turn off automatically after the time set in [**2**: Auto power off] (p.59). If [**2**: Auto power off] is set to [Disable], Live View shooting will end automatically after 30 min. (camera power remains on).
- With the HDMI cable HTC-100 (sold separately) or stereo AV cable AVC-DC400ST (sold separately), you can display the Live View image on a TV screen (p.316, 319).

Information Display

- Each time you press the <INFO.> button, the information display will change.

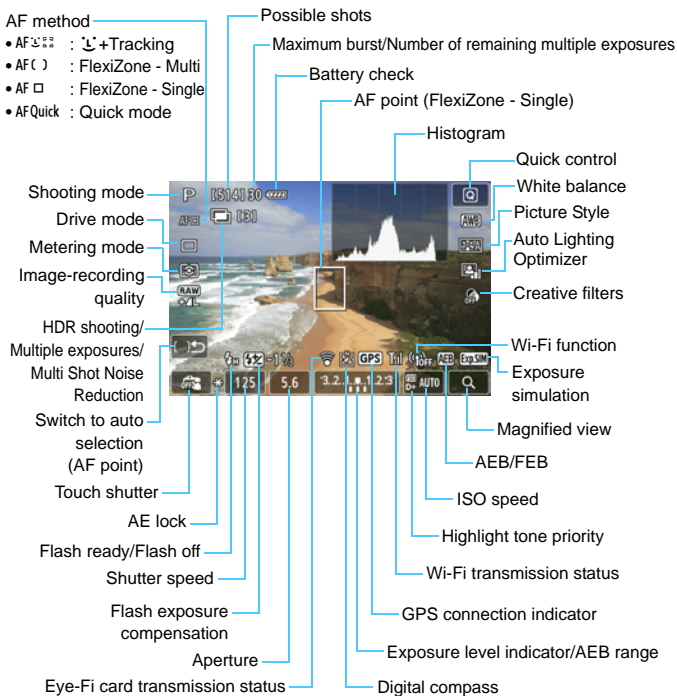



Do not hold the camera in the same position for long periods of time.

Even if the camera does not feel too hot, prolonged contact with the same body part may cause skin redness, blistering or low-temperature contact burns. The use of a tripod is recommended for people with circulation problems or very sensitive skin, or when using the camera in very hot places.



- The histogram can be displayed when [1: Expo. simulation: Enable] (p.230) is set.
- You can display the electronic level by pressing the <INFO.> button (p.65). Note that if the AF method is set to [+Tracking] or the camera is connected to a TV set with an HDMI cable, the electronic level cannot be displayed.
- When <Exp.SIM> is displayed in white, it indicates that the Live View image brightness is close to what the captured image will look like.
- If <Exp.SIM> is blinking, it indicates that the Live View image is displayed at a brightness that differs from the actual shooting result because of low- or bright-light conditions. However, the actual image recorded will reflect the exposure setting. Note that noise may be more noticeable than the actual image recorded.
- If the <> or <> mode is set, Multi Shot Noise Reduction is set, or bulb or flash is used, the <Exp.SIM> icon and histogram will be grayed out (for your reference). The histogram may not be properly displayed in low- or bright-light conditions.

Scene Icons

In the <A+> shooting mode, the camera detects the scene type and sets everything automatically to suit the scene. The detected scene type is indicated on the upper left of the screen. For certain scenes or shooting conditions, the icon displayed may not match the actual scene.

Background \ Subject	Portrait ^{*1}		Non-portrait			Background Color
		Movement	Nature and Outdoor Scene	Movement	Close ^{*2}	
Bright						Gray
	Backlit					
Blue Sky Included						Light blue
	Backlit					
Sunset	*3				*3	Orange
Spotlight						Dark blue
Dark						
With Tripod	*4*5	*3	*4*5	*3		

*1: Displayed only when the AF method is set to [**A+**+Tracking]. If another AF method is set, the “Non-portrait” icon will be displayed even if a person is detected.

*2: Displayed when the attached lens has distance information. With an Extension Tube or Close-up Lens, the icon displayed may not match the actual scene.

*3: The icon suiting the scene detected will be displayed.

*4: Displayed when all the following conditions apply: The shooting scene is dark, it is a night scene, and the camera is mounted on a tripod.

*5: Displayed with any of the lenses below:

- EF-S18-55mm f/3.5-5.6 IS II
- EF-S55-250mm f/4-5.6 IS II
- EF300mm f/2.8L IS II USM
- EF400mm f/2.8L IS II USM
- Image Stabilizer lenses marketed in 2012 or later.

*4+*5: If the conditions in both *4 and *5 are met, the shutter speed will slow down.

Final Image Simulation

The final image simulation reflects the settings of the Picture Style, white balance and other functions in the Live View image so you can see what the captured image will look like.



The Live View image will automatically reflect the effects of the settings listed below.





Final Image Simulation During Live View Shooting



- Picture Style
 - * All settings such as sharpness, contrast, color saturation, and color tone will be reflected.
- White balance
- White balance correction
- Creative filters
- Ambience-based shots
- Lighting/scene based shots
- Metering mode
- Exposure (with [ 1: Expo. simulation: Enable] set)
- Depth of field (with depth-of-field preview button ON)
- Auto Lighting Optimizer
- Peripheral illumination correction
- Chromatic aberration correction
- Highlight tone priority
- Aspect ratio (image area confirmation)

Shooting Function Settings

AF / DRIVE / ISO / / Settings

While the Live View image is displayed, if you press the <AF>, <DRIVE>, <ISO>, or <> button, the setting screen will appear on the LCD monitor and you can turn the <> or <> dial to set the respective shooting function.

When the Quick mode is set, you can press the <> button to select the AF area selection mode. With single-point AF (manual selection) and Zone AF, you can use <>, <>, or <> to select an AF point or zone.

-  When you set  (Partial metering) or  (Spot metering), a metering circle will be displayed in the center.
- During Live View shooting, the exposure is set at the moment the picture is taken, regardless of the metering mode.

Q Quick Control

In Creative Zone modes, you can set the **AF method**, **Drive mode**, Metering mode, **Image-recording quality**, White balance, Picture Style, Auto Lighting Optimizer, and **Creative Filters**.

In Basic Zone modes (except <P> and <A>), you can set the functions in bold and the settings shown in the table on page 91.



1 Press the <Q> button. (10)

- ▶ The settable functions will be displayed.

2 Select a function and set it.

- Press the <▲▼> key to select a function.
- ▶ The selected function and Feature guide (p.69) will appear.
- Set it by pressing the <◀▶> key.
- In the <SCN> mode, select the shooting mode option on the upper left of the screen, then press <SET> to select the shooting mode.
- To set the RAW image-recording quality or Picture Style parameters, press the <INFO.> button.

3 Exit the setting.

- Press <SET> to finalize the setting and return to Live View shooting.

Shooting with Filter Effects

While viewing the Live View image, you can apply a filter effect (Grainy B/W, Soft focus, Fish-eye effect, Art bold effect, Water painting effect, Toy camera effect, or Miniature effect) before shooting. These are called Creative filters.

When you take the picture, the camera saves only the image with the Creative filter applied. If you also want to save the image without a Creative filter applied, take the picture without a Creative filter. Then apply a Creative filter effect and save it as a new image (p.335).

1 Set any shooting mode except <P> or <A>.

2 Press the <Q> button. (10)

▶ Quick Control will appear.

3 Select [OFF].

- Press the <▲▼> key to select [OFF] (Creative filters) on the screen's right side.



4 Select a filter.

- Press the <◀▶> key to select the desired filter effect (p.226).
- ▶ The image will be displayed with the selected filter applied.







5 Adjust the filter effect.

- Press the <INFO.> button (except for the Miniature effect).
- Press the <◀▶> key to adjust the filter effect, then press <SET>.
- For the Miniature effect, press <SET>, then press the <▲▼> key to move the white frame over the area you want the image look sharp.





6 Take the picture.

- ▶ The image is shot with the filter applied.

 When you set a Creative filter, single shooting will take effect even if the drive mode has been set to <H>, <S>, or <S>.

-  ● You cannot use a Creative filter if the recording quality is RAW+JPEG or RAW, or if you have set AEB, white balance bracketing, or Multi Shot Noise Reduction.
- The histogram is not displayed when you shoot with Creative filters.

Creative Filter Characteristics

-  **Grainy B/W**
Creates a grainy black-and-white photo. You can change the black-and-white effect by adjusting the contrast.
-  **Soft focus**
Gives the image a soft look. You can change the degree of softness by adjusting the blur.
-  **Fish-eye effect**
Gives the effect of a fish-eye lens. The image will have a barrel-type distortion.
Depending on the level of this filter effect, the area trimmed along the periphery of the image changes. Also, since this filter effect expands the image center, the image resolution at the center may decrease depending on the recording quality. Set the filter while checking how the image looks. The AF method will be set to FlexiZone - Single (fixed at center) or Quick mode (fixed at center).
-  **Art bold effect**
Makes the photo look like an oil painting and the subject look three-dimensional. You can adjust the contrast and saturation. Note that the sky, white walls, and similar subjects may not be rendered with a smooth gradation and may look irregular or have significant noise.
-  **Water painting effect**
Makes the photo look like a watercolor painting with soft colors. You can adjust the color density. Note that night scenes or dark scenes may not be rendered with a smooth gradation and may look irregular or have significant noise.

-  **Toy camera effect**

Darkens the photo's corners and applies a color tone that makes it look as if it was shot by a toy camera. You can change the color cast by adjusting the color tone.

-  **Miniature effect**

Creates a diorama effect. You can change where the image looks sharp. In step 5, you can switch the horizontal/vertical orientation of the white frame by pressing the <@> button (or tapping [] on the screen). The AF method will be FlexiZone - Single to focus at the center of the white frame.



- With Grainy B/W, the grainy look displayed on the LCD monitor will be different from the actual image.
- With the Soft focus and Miniature effects, the blur effect displayed on the LCD monitor may not look the same as the actual image. By pressing the depth-of-field preview button, you can check the image's blur effect (Creative Zone modes only).

MENU Menu Function Settings

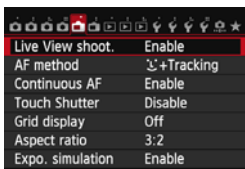

When the Live View shooting/Movie shooting switch is set to , the Live View shooting menu options will appear under the [1] and [2] tabs.

In Basic Zone modes, the [2] tab and certain options under the [1] tab will not appear.

The settable functions on this menu screen apply only to Live View shooting. They do not work with viewfinder shooting (settings become invalid).

- **Live View shooting**

You can set Live View shooting to [Enable] or [Disable].

- **AF method**

You can select ['+Tracking'], [FlexiZone - Multi], [FlexiZone - Single] or [Quick mode]. See pages 233-244 for the AF method.

- **Continuous AF**

The default setting is [Enable].

The camera attains rough focus of the subject continuously. This makes it quicker to achieve focus when you press the shutter button halfway. If [Enable] is set, the lens will operate constantly and consume more battery power. This will reduce the number of possible shots (battery life). Also, if the AF method is set to [Quick mode], Continuous AF will be automatically set to [Disable]. If you select another AF method, Continuous AF will revert to the original setting.

If you want to set the lens focus mode switch to <MF> during Continuous AF, first stop Live View shooting.

- **Touch Shutter**

Just by tapping the LCD monitor screen, you can focus and take the picture automatically. For details, see page 245.

- **Grid display**

With [3x3 \oplus] or [6x4 \oplus], you can display grid lines to help you level the camera vertically or horizontally. Also, with [3x3+diag \oplus], the grid is displayed together with diagonal lines to help you align the intersections over the subject for better balance in the composition.

- **Aspect ratio ☆**

The image's aspect ratio can be set to [3:2], [4:3], [16:9], or [1:1].

The area surrounding the Live View image is masked in black when the following aspect ratios are set: [4:3] [16:9] [1:1].

JPEG images will be saved with the set aspect ratio. RAW images will always be saved with the [3:2] aspect ratio. Since the aspect ratio information is appended to the RAW image, the image can be generated in the respective aspect ratio when you process the RAW image with the camera and the provided software.

Image Quality	Aspect Ratio and Pixel Count (approx.)			
	3:2	4:3	16:9	1:1
L / RAW	5472x3648 (20.0 megapixels)	4864x3648 (17.7 megapixels)	5472x3072* (16.8 megapixels)	3648x3648 (13.3 megapixels)
M	3648x2432 (8.9 megapixels)	3248x2432* (7.9 megapixels)	3648x2048* (7.5 megapixels)	2432x2432 (5.9 megapixels)
M RAW	4104x2736 (11.2 megapixels)	3648x2736 (10.0 megapixels)	4104x2310* (9.5 megapixels)	2736x2736 (7.5 megapixels)
S1/S RAW	2736x1824 (5.0 megapixels)	2432x1824 (4.4 megapixels)	2736x1536* (4.2 megapixels)	1824x1824 (3.3 megapixels)
S2	1920x1280 (2.5 megapixels)	1696x1280* (2.2 megapixels)	1920x1080 (2.1 megapixels)	1280x1280 (1.6 megapixels)
S3	720x480 (350,000 pixels)	640x480 (310,000 pixels)	720x408* (290,000 pixels)	480x480 (230,000 pixels)

- 
 - The asterisked image-recording quality settings do not match the respective aspect ratio exactly.
 - The image area displayed for the asterisked aspect ratio is slightly larger than the recorded area. Check the captured images on the LCD monitor when shooting.
 - If you use a different camera to directly print images shot with this camera in the 1:1 aspect ratio, the images may not be correctly printed.

• Exposure simulation [☆]

Exposure simulation simulates and displays how the brightness of the actual image (exposure) will look.

• Enable (Exp.SIM)

The displayed image brightness will be close to the actual brightness (exposure) of the resulting image. If you set exposure compensation, the image brightness will change accordingly.

• During (DISP/Exp.SIM)

Normally, the image is displayed at the standard brightness to make the Live View image easy to see. The image will be displayed close to the actual brightness (exposure) of the resulting image only while you hold down the depth-of-field preview button.

• Disable (DISP)

The image is displayed at the standard brightness to make the Live View image easy to see. Even if you set exposure compensation, the image is displayed at the standard brightness.

 2 ☆

- **Silent LV shooting** ☆

- **Mode 1**

The shooting operation noise is quieter than with normal shooting. Continuous shooting is also possible. If <  H > is set, you can shoot at a maximum continuous shooting speed of approx. 7.0 fps.

- **Mode 2**

When the shutter button is pressed completely, only one shot will be taken. While you keep holding down the shutter button, the camera operation will be suspended. Then when you return to the shutter button's halfway position, the camera operation will resume. The shooting noise is thereby minimized. Even if continuous shooting is set, only a single shot will be taken.

- **Disable**

Be sure to set it to **[Disable]** if you use a TS-E lens (other than those listed in  below) **for shifting or tilting the lens** or if you use an Extension tube. If **[Mode 1]** or **[Mode 2]** is set, the standard exposure may not be obtained or an irregular exposure may result.



- If you use flash, silent shooting will not be possible regardless of the **[Silent LV shoot.]** setting.
- When using a non-Canon flash unit, set it to **[Disable]**. The flash will not fire if it is set to **[Mode 1]** or **[Mode 2]**.
- If **[Mode 2]** is set and you use a Remote Controller (p.184), the operation will be the same as with **[Mode 1]**.



With the TS-E17mm f/4L or TS-E24mm f/3.5L II lens, you can use **[Mode 1]** or **[Mode 2]**.

- **Metering timer** [☆]

You can change how long the exposure setting is displayed (AE lock time).

 Performing any of the following operations will stop Live View shooting. To start Live View shooting again, press the START/STOP button.

- Selecting [**4: Dust Delete Data**], [**4: Sensor cleaning**], [**4: Clear all camera settings**], or [**4: firmware ver.**].
- Changing the shooting mode (example: Basic Zone modes ↔ Creative Zone modes).

Using AF to Focus (AF Method)

Changes in AF Speed Depending On the AF Control Method

If the AF method is set to [**Ⓜ**+Tracking], [**FlexiZone - Multi**], or [**FlexiZone - Single**] for Live View shooting or movie shooting, the AF control method (phase-difference detection with the image sensor or contrast detection) will switch automatically depending on the lens used and functions selected, such as movie digital zoom or magnified view. This can greatly affect the AF speed and the camera may take a longer time to focus (phase-difference detection generally allows faster AF focusing). For details, refer to Canon Web site.

Selecting the AF Method

You can select an AF method to suit the shooting conditions and your subject. The following AF methods are provided: [**Ⓜ**(face)+Tracking], [**FlexiZone - Multi**] (p.236), [**FlexiZone - Single**] (p.238), and [**Quick mode**] (p.243).

If you want to achieve precise focus, set the lens focus mode switch to <MF>, magnify the image, and focus manually (p.247).

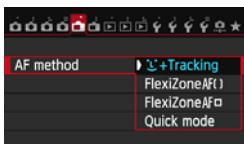

Select the AF method.

- Under the [**1**] tab, select [**AF method**].
- Select the desired AF method, then press <SET>.
- While the Live View image is displayed, you can also press the <AF> button to select the AF method on the setting screen.

Ⓜ(face)+Tracking: AF Ⓜ

The camera detects and focuses human faces. If a face moves, the AF point <[]> also moves to track the face.

1 Display the Live View image.

- Press the <START/STOP> button.
- ▶ The Live View image will appear on the LCD monitor.



2 Select an AF point.

- When a face is detected, the <[]> frame will appear over the face to be focused.
- If multiple faces are detected, <[]> will be displayed. Use <[]> to move the <[]> frame over the face you want to focus on.
- You can also tap the LCD monitor screen to select the face or subject. If the subject is not a face, <[]> will be displayed.
- If no faces can be detected, or if you tap the LCD monitor but do not select any face or subject, the camera will switch to [FlexiZone - Multi] with automatic selection (p.236).

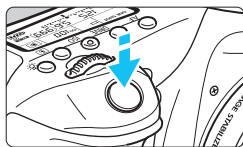

3 Focus the subject.

- Press the shutter button halfway to focus.
- ▶ When focus is achieved, the AF point will turn green and the beeper will sound.
- ▶ If focus is not achieved, the AF point will turn orange.



4 Take the picture.

- Check the focus and exposure, then press the shutter button completely to take the picture (p.216).



- If the subject's face is significantly out of focus, face detection will not be possible. You can prevent this by setting **[Continuous AF]** to **[Enable]**.
- An object other than a human face may be detected as a face.
- Face detection will not work if the face is very small or large in the picture, too bright or too dark, or partially hidden.
- The <[]> may cover only part of the face.



- You can press <[SET]> or the <[]> button to display the AF point <[]> at the center and use <[]> to move the AF point.
- Since AF is not possible with a face detected near the edge of the picture, the <[]> will be grayed out. If you press the shutter button halfway, the subject will be focused in FlexiZone - Multi method with automatic selection.

FlexiZone - Multi: AF ()

You can focus over a wide area with up to 31 AF points (automatic selection). This wide area can also be divided into 9 zones for focusing (zone selection).

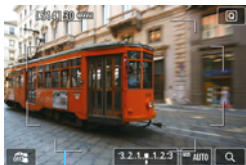

Area frame

1 Display the Live View image.

- Press the $\langle \text{START/STOP} \rangle$ button.
- ▶ The Live View image will appear on the LCD monitor.

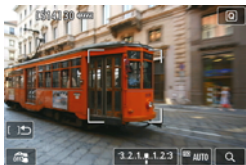

2 Select the AF point. ☆

- Pressing $\langle \text{SET} \rangle$ or the $\langle \text{TRIP} \rangle$ button will toggle between automatic selection and zone selection. In Basic Zone modes, automatic selection is set automatically.
- Use $\langle \text{ZONES} \rangle$ to select the zone. To return to the center zone, press $\langle \text{SET} \rangle$ or the $\langle \text{TRIP} \rangle$ button again.
- You can also tap the LCD monitor screen to select a zone.

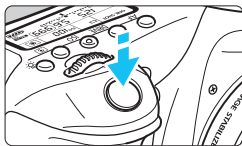

3 Focus the subject.

- Aim the AF point over the subject and press the shutter button halfway.
- ▶ When focus is achieved, the AF point will turn green and the beeper will sound.
- ▶ If focus is not achieved, the area frame will turn orange.



4 Take the picture.

- Check the focus and exposure, then press the shutter button completely to take the picture (p.216).



- If the camera does not focus the desired target subject with automatic AF point selection, switch the AF method to zone selection or [**FlexiZone - Single**] and refocus.
- Depending on the [**1: Aspect ratio**], the number of AF points will differ. At [**3:2**], there will be 31 AF points. At [**4:3**] and [**1:1**], there will be 25 AF points. And at [**16:9**], 21 AF points. Also, at [**16:9**], there will be only three zones.
- For movie shooting, there will be 21 AF points (or 25 AF points if [**640x480**] is set) and three zones (or 9 zones if [**640x480**] is set).

FlexiZone - Single: AF □

The camera focuses with a single AF point. This is effective when you want to focus a particular subject.



AF point

1 Display the Live View image.

- Press the $\langle \text{START/STOP} \rangle$ button.
- ▶ The Live View image will appear on the LCD monitor.
- ▶ The AF point $\langle \square \rangle$ will appear.
- During movie shooting, if **[Movie Servo AF]** is set to **[Enable]**, the AF point will be displayed in a larger size.



2 Move the AF point.

- Use $\langle \text{DIAL} \rangle$ to move the AF point to where you want to focus. (It cannot be moved to the edge of the screen.)
- To return the AF point to the center, press $\langle \text{SET} \rangle$ or $\langle \text{RESET} \rangle$ button.
- You can also tap the LCD monitor screen to move the AF point.

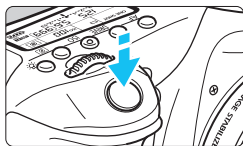

3 Focus the subject.

- Aim the AF point over the subject and press the shutter button halfway.
- ▶ When focus is achieved, the AF point will turn green and the beeper will sound.
- ▶ If focus is not achieved, the AF point will turn orange.



4 Take the picture.

- Check the focus and exposure, then press the shutter button completely to take the picture (p.216).

Notes for +Tracking / FlexiZone - Multi / FlexiZone - Single

AF Operation

- Even when focus has been achieved, pressing the shutter button halfway will focus again.
- The image brightness may change during and after the AF operation.
- If the light source changes while the Live View image is displayed, the screen may flicker and focusing may be difficult. If this happens, exit Live View shooting and autofocus under the actual light source.
- When [**FlexiZone - Multi**] is set and you press the <Q> button (or tap <Q> on the screen), the center of the selected zone (or image center with automatic selection) will be magnified. If you press the shutter button halfway, the display will return to normal and the camera will focus.
- When [**FlexiZone - Single**] is set and you press the <Q> button (or tap <Q> on the screen), the area covered by the AF point will be magnified. Press the shutter button halfway to focus while in magnified view. This is effective when the camera is attached to a tripod and you need to attain very precise focus. If focusing is difficult in magnified view, return to the normal display and use AF. Note that the AF speed may differ between the normal and magnified views.
- If you magnify the view after focusing with [**FlexiZone - Multi**] or [**FlexiZone - Single**] in the normal view, precise focus may not be achieved.
- If [ +Tracking] is set, magnified view is not possible.

- With certain types of lenses, the AF control method (phase-difference detection with the image sensor or contrast detection) will switch automatically. The AF speed may therefore change greatly and focusing may take longer.
- When in magnified view, contrast-detection AF will be used regardless of the lens used. The AF speed will therefore become slow.
- When in magnified view, Continuous AF (p.228) will not be executed.

Shooting Conditions that Make Focusing Difficult

- Low-contrast subjects such as the blue sky, solid-color flat surfaces or when highlight or shadow details are lost.
- Subjects in low light.
- Stripes and other patterns where there is contrast only in the horizontal direction.
- Subjects with repetitive patterns (skyscraper windows, computer keyboards, etc.).
- Fine lines and subject outlines.
- Under a light source whose brightness, color, or pattern keeps changing.
- Night scenes or points of light.
- Under fluorescent or LED light sources and when the image flickers.
- Extremely small subjects.
- Subjects at the edge of the picture.
- Subjects strongly reflecting light.
- The AF point covers both near and distant subjects (such as an animal in a cage).
- Subjects that keep moving within the AF point and cannot keep still due to camera shake or subject blur.
- A subject approaching or moving away from the camera.
- Autofocusing while the subject is very far out of focus.
- Soft focus effect is applied with a soft focus lens.
- A special effect filter is used.
- Noise (spots, banding, etc.) appears on the screen during AF.

 If you cannot achieve focus under the shooting conditions listed on the preceding page, set the lens focus mode switch to <MF> and focus manually.

- 
- If you shoot a peripheral subject and it is slightly out of focus, aim the center AF point or zone over the subject to focus, focus again, and then take the picture.
 - The AF-assist beam will not be emitted. However, if an EX-series Speedlite (sold separately) equipped with an LED light is used, the LED light will turn on for AF-assist when necessary.
 - During magnified view, camera shake may make it harder to achieve focus. Using a tripod is recommended.

Quick Mode: AFQuick

The dedicated AF sensor is used to focus in One-Shot AF mode (p.100), using the same AF method as with viewfinder shooting.

Although you can focus the target area quickly, **the Live View image will be interrupted momentarily during the AF operation.**

In AF area selection modes other than 19-point automatic selection AF, you can manually select the AF point. In Basic Zone modes, 19-point automatic selection AF is set automatically.

Area AF frame



1 Display the Live View image.

- Press the <START/STOP> button.
- ▶ The Live View image will appear on the LCD monitor.
- If the AF area selection mode is set to 19-point automatic selection AF, the Area AF frame will be displayed.
- With FlexiZone - Single (manual selection), the AF point will be displayed as a small frame.
- With Zone AF (manual zone selection), the frame indicating the zone is displayed.

2 Select the AF area selection mode and AF point. ☆

- Press the <AF AREA> button to display the current AF area selection mode.
- Each time you press the <AF AREA> button, the AF area selection mode changes.
- When the AF area selection mode is FlexiZone - Single (manual selection) or Zone AF (manual zone selection), you can select the AF point (or zone).

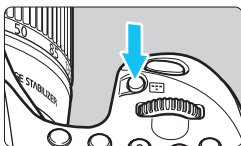

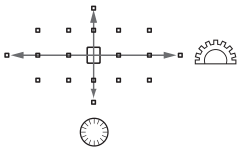

- The AF point (or zone) selection will change in the direction you tilt .
- If you press , the center AF point (or center Zone) will be selected.
- You can also use the and dials to select the AF point.

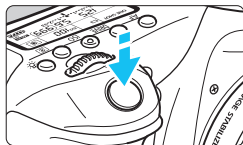

3 Focus the subject.

- Aim the AF point over the subject and press the shutter button halfway.
- ▶ The Live View image will turn off, the reflex mirror will go back down, and AF will be executed. (No picture is taken.)
- ▶ When focus is achieved, the beeper will sound and the Live View image will reappear.
- ▶ The AF point used to focus will light up in green.
- ▶ If focus is not achieved, the AF point will blink in orange.

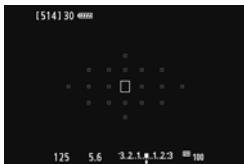

4 Take the picture.

- Check the focus and exposure, then press the shutter button completely to take the picture (p.216).



- When [Quick mode] is set, [Continuous AF] will automatically be set to [Disable].
- Quick mode cannot be set for movie shooting.

 You cannot take a picture during autofocus. Take the picture while the Live View image is displayed.

Shooting with the Touch Shutter

Just by tapping the LCD monitor screen, you can focus and take the picture automatically. This works in all shooting modes.







1 Display the Live View image.

- Press the <  > button.
- ▶ The Live View image will appear on the LCD monitor.





2 Enable the touch shutter.

- Tap [] on the screen's bottom left. Each time you tap the icon, it will toggle between [] and [].
- [] (Touch shutter: Enable)
You can focus and shoot by tapping the screen.
- [] (Touch shutter: Disable)
You can select where you want to focus by tapping the screen. Then you press the shutter button completely to take the picture.



3 Tap the screen to shoot.

- Tap the face or subject on the screen.
- ▶ At the point you tap, the camera will focus in the AF method that was set (p.233-244).
- ▶ When focus is achieved, the AF point turns green and the picture is taken automatically.
- If focus is not achieved, the AF point will turn orange. Tap the face or subject on the screen again.

- Even if H>, , or S> is set, single shooting will take effect.
- The touch shutter does not function during magnified view.
- When [ **Shutter butt. half-press**] is set to [**Metering start**] or [**AE lock (while button pressed)**] under [ **C.Fn III-4: Custom Controls**], autofocusing does not take effect.

- You can also set the touch shutter with [ **1: Touch shutter**].
- To take a bulb exposure, tap the screen twice. The first tap on the screen will start the bulb exposure. Tapping it again will stop the exposure. Be careful not to shake the camera when tapping the screen.

MF: Focusing Manually

You can magnify the image and focus precisely with manual focus.

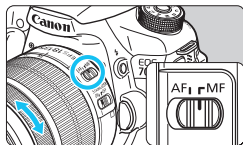

1 Set the lens focus mode switch to <MF>.

- Turn the lens focusing ring to focus roughly.

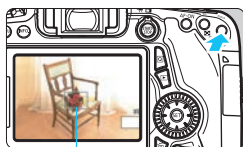

Magnifying frame

2 Display the magnifying frame.

- Press the <Q> button.
- ▶ The magnifying frame will appear.
- You can also tap [Q] on the screen to magnify the image.

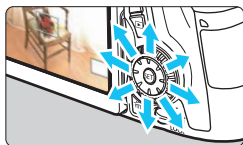

3 Move the magnifying frame.

- Press <⬤> to move the magnifying frame to the position where you want to focus. You can also tap it to move it.
- To return the magnifying frame to the center, press <SET> or <⏏> button.

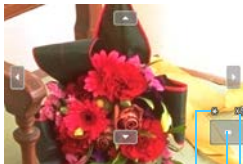

AE lock
Magnified area position
Magnification

4 Magnify the image.

- Each time you press the <Q> button, the magnification within the frame will change as follows:

→ 1x → 5x → 10x → Normal view

- While in magnified view, you can use <⬤> to scroll around in magnified view.

5 Focus manually.

- While looking at the magnified image, turn the lens focusing ring to focus.
- After achieving focus, press the <Ⓜ> button to return to the normal view.

6 Take the picture.







- Check the focus and exposure, then press the shutter button completely to take the picture (p.216).

Live View Shooting Cautions

Image Quality

- When you shoot at high ISO speeds, noise (such as dots of light and banding) may become noticeable.
- Shooting in high temperatures may cause noise and irregular colors in the image.
- If Live View shooting is used continuously for a prolonged period, the camera's internal temperature may rise, and image quality may deteriorate. Always exit Live View shooting when you are not shooting.
- If you shoot a long exposure while the camera's internal temperature is high, image quality may deteriorate. Exit Live View shooting and wait a few minutes before shooting again.

White and Red Internal Temperature Warning Icons

- If the camera's internal temperature increases due to prolonged Live View shooting or under a high ambient temperature, a white  or red  icon will appear.
- The white  icon indicates that the image quality of still photos will deteriorate. You should exit Live View shooting and allow the camera's internal temperature to cool before shooting again.
- The red  icon indicates that the Live View shooting will soon stop automatically. If this happens, you will not be able to shoot again until the camera's internal temperature decreases. Exit the Live View shooting or turn off the power and let the camera rest for a while.
- Using Live View shooting at a high temperature for a prolonged period will cause the  or  icon to appear earlier. When you are not shooting, turn off the camera.
- If the camera's internal temperature is high, the image quality of high ISO speed images or long exposures may deteriorate even before the white  icon is displayed.

Shooting Result

- If you take the picture in magnified view, the exposure may not come out as desired. Return to the normal view before taking the picture. In magnified view, the shutter speed and aperture will be displayed in orange. Even if you take the picture in magnified view, the image will be captured in the normal view range.
- If **[ 3: Auto Lighting Optimizer]** (p.140) is set to other than **[Disable]**, the image may look bright even if a decreased exposure compensation or decreased flash exposure compensation is set.

Live View Shooting Cautions

Live View Image

- Under low- or bright-light conditions, the Live View image may not reflect the brightness of the captured image.
- Even if a low ISO speed is set, noise may be noticeable in the displayed Live View image under low light. However, when you shoot, the image recorded will have minimal noise. (The image quality of the Live View image is different from that of the recorded image.)
- If the light source (illumination) within the image changes, the screen may flicker. If this happens, exit Live View shooting and resume shooting under the actual light source.
- If you point the camera in a different direction, it may throw off the Live View image's correct brightness momentarily. Wait until the brightness level stabilizes before shooting.
- If there is a very bright light source in the picture, the bright area may appear black on the LCD monitor. However, the actual captured image will correctly show the bright area.
- In low light, if you set the [**⚡2: LCD brightness**] to a bright setting, noise or irregular colors may appear in the Live View image. However, the noise or irregular colors will not be recorded in the captured image.
- When you magnify the image, the image sharpness may look more pronounced than in the actual image.

Custom Functions

- During Live View shooting, some Custom Function settings will not take effect (p.363).

Lens and Flash

- The focus preset function is possible for Live View shooting only when using a (super) telephoto lens equipped with the focus preset mode, available since the second half of 2011.
- FE lock will not work if the built-in flash is used. FE lock and modeling flash will not work if an external Speedlite is used.

8

Shooting Movies

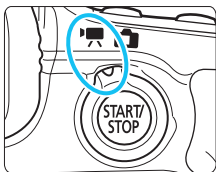

Movie shooting is enabled by setting the Live View shooting/Movie shooting switch to . The movie recording format will be MOV.

- For cards that can record movies, see page 3.
- If you handhold the camera and shoot movies, camera shake can cause blurred movies. Using a tripod is recommended.
- To shoot while handholding the camera, see page 76.



If [**Wi-Fi**] is set to [**Enable**], movie shooting is not possible. Before shooting movies, set [**Wi-Fi**] to [**Disable**].



Full HD 1080

Full HD 1080 indicates compatibility with High-Definition featuring 1080 vertical pixels (scanning lines).



Shooting Movies

Autoexposure Shooting

When the shooting mode is set to other than <M>, autoexposure control will take effect to suit the scene's current brightness.

1 Set the shooting mode to a mode other than <M>.

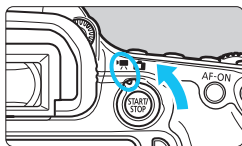

2 Set the Live View shooting/Movie shooting switch to <Movie>.

- ▶ The reflex mirror will make a sound, then the image will appear on the LCD monitor.

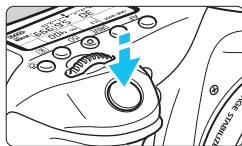

3 Focus the subject.

- Before shooting a movie, focus with AF or manual focus (p.233-248).
- When you press the shutter button halfway, the camera will focus with the current AF method.

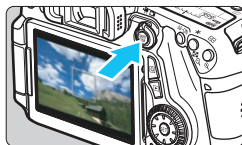

4 Shoot the movie.

- Press the <START/STOP> button to start shooting a movie.
- ▶ While the movie is being shot, the “●” mark will be displayed on the upper right of the screen.
- To stop shooting the movie, press the <START/STOP> button again.

Recording movies



Microphone



- In Basic Zone modes, the shooting result will be the same as in the <A+> mode. Also, the scene icon for the scene detected by the camera is displayed on the upper left of the screen (p.255).
- In the <Tv>, <Av>, or shooting modes, the settings will be the same as in the <P> mode.
- Settable menu functions will differ between Basic Zone modes and Creative Zone modes (p.415).
- In Creative Zone modes, you can press the <★> button (p.170) to lock the exposure (AE lock). The exposure setting will be displayed for the time length set with [CAM 1: Metering timer]. After applying AE lock during movie shooting, you can cancel it by pressing the <⊞> button. (AE lock setting is retained until you press the <⊞> button.)
- In Creative Zone modes, you can set exposure compensation by sliding the <LOCK> switch downward and turning the <⊙> dial.
- Pressing the shutter button halfway displays the ISO speed and shutter speed at the screen bottom. This is the exposure setting for taking a still photo (p.258). The exposure setting for movie shooting is not displayed. Note that the exposure setting for movie shooting may differ from that for still photo shooting.
- If you shoot a movie with autoexposure, the shutter speed and aperture will not be recorded in the image information (Exif).

ISO Speed in Basic Zone Modes

- The ISO speed will be set automatically within ISO 100 - ISO 6400.

ISO Speed in the P, Tv, Av, and B Mode

- The ISO speed will be set automatically within ISO 100 - ISO 6400.
- Under [**3: ISO speed settings**], if you set [**ISO speed range**]'s [**Maximum**] setting to [**12800/H**] (p.123), the maximum ISO speed for the automatic ISO speed setting will be expanded to H (equivalent to ISO 12800). Be aware that if you set [**Maximum**] to [**12800**], the maximum ISO speed will not be expanded and remains ISO 6400.
- If [**4: Highlight tone priority**] is set to [**Enable**] (p.145), the ISO speed will be ISO 200 - ISO 6400.
- Under [**3: ISO speed settings**], [**Auto ISO range**] or [**Min. shutter spd.**] cannot be set (p.124, 125) for movie shooting.



















📌 Under [**ISO speed range**], if [**Maximum**] is set to [**H (25600)**] and you switch from still photo shooting to movie shooting, the maximum ISO speed for the automatic ISO range during movie shooting will be H (equivalent to ISO 12800). It cannot be expanded to ISO 25600.

Using an EX-series Speedlite (Sold Separately) Equipped with an LED Light

With autoexposure (modes other than **M**) movie shooting, the camera will automatically turn on the Speedlite's LED light under low-light conditions. **For details, refer to the EX-series Speedlite's instruction manual.**

Scene Icons

During movie shooting in a Basic Zone mode, an icon representing the scene detected by the camera will be displayed and the shooting will be adapted to that scene. For certain scenes or shooting conditions, the icon displayed may not match the actual scene.

Subject Background	Portrait ^{*1}	Non-Portrait		Background Color
		Nature and Outdoor Scene	Close ^{*2}	
Bright				Gray
Backlit				
Blue Sky Included				Light blue
Backlit				
Sunset	*3		*3	Orange
Spotlight				Dark blue
Dark				

*1: Displayed only when the AF method is set to [+Tracking]. If another AF method is set, the "Non-portrait" icon will be displayed even if a person is detected.

*2: Displayed when the attached lens has distance information. With an Extension Tube or Close-up Lens, the icon displayed may not match the actual scene.

*3: The icon suiting the scene detected will be displayed.

Manual Exposure Shooting

You can manually set the shutter speed, aperture, and ISO speed for movie shooting. Using manual exposure to shoot movies is for advanced users.



1 Set the Mode Dial to <M>.

2 Set the Live View shooting/Movie shooting switch to <[Movie Icon]>.

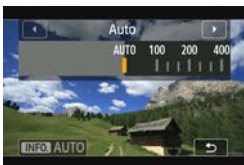

3 Set the ISO speed.

- Press the <ISO> button.
- ▶ The ISO speed setting screen will appear on the LCD monitor.
- Turn the <[ISO Dial]> dial to set the ISO speed.
- For details on the ISO speed, see the next page.

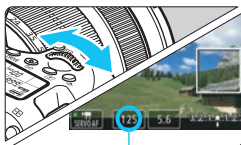

Shutter speed

4 Set the shutter speed and aperture.

- Press the shutter button halfway and check the exposure level indicator.
- To set the shutter speed, turn the <[Shutter Speed Dial]> dial. The settable shutter speeds depend on the frame rate <[Frame Rate]>.
 - [30] [25] [24] : 1/4000 sec. - 1/30 sec.
 - [60] [50] : 1/4000 sec. - 1/60 sec.
- To set the aperture, turn the <[Aperture Dial]> dial.
- If it cannot be set, set the <LOCK> switch downward, then turn the <[Shutter Speed Dial]> or <[Aperture Dial]> dial.



Aperture

5 Focus and shoot the movie.

- The procedure is the same as steps 3 and 4 for “Autoexposure Shooting” (p.252).

ISO Speed During Manual Exposure Shooting

- With **[Auto] (A)**, the ISO speed will be set automatically within ISO 100 - ISO 6400. Under **[CAMERA 3: ISO speed settings]**, if you set **[ISO speed range]**'s **[Maximum]** setting to **[12800/H]** (p.123), the maximum ISO speed will be expanded and the ISO speed will be set automatically within ISO 100 to H (equivalent to ISO 12800).
- You can set the ISO speed manually within ISO 100 - ISO 6400 in 1/3-stop increments. Under **[CAMERA 3: ISO speed settings]**, if you set **[ISO speed range]**'s **[Maximum]** setting to **[12800/H]**, the maximum ISO speed for the manual ISO speed setting will be expanded to H (equivalent to ISO 12800). Be aware that when you set **[Maximum]** to **[12800]**, the maximum ISO speed will not be expanded and remains ISO 6400.
- If **[CAMERA 4: Highlight tone priority]** is set to **[Enable]** (p.145), the ISO speed will be ISO 200 - ISO 6400 (depending on the **[ISO speed range]** setting).
- Under **[CAMERA 3: ISO speed settings]**, **[Auto ISO range]** or **[Min. shutter spd.]** cannot be set (p.124, 125) for movie shooting.



- Since shooting a movie at ISO 8000/10000/12800 may result in much noise, it is designated as an expanded ISO speed (displayed as **[H]**).
- Under **[ISO speed range]**, if **[Maximum]** is set to **[H (25600)]** and you switch from still photo shooting to movie shooting, the maximum ISO speed for the manual ISO range during movie shooting will be H (equivalent to ISO 12800). It cannot be expanded to ISO 25600.
- Changing the shutter speed or aperture during movie shooting is not recommended since the changes in the exposure will be recorded.
- When shooting a movie of a moving subject, a shutter speed of 1/30 sec. to 1/125 sec. is recommended. The faster the shutter speed, the less smooth the subject's movement will look.
- If you change the shutter speed while shooting under fluorescent or LED lighting, image flicker may be recorded.



- When Auto ISO is set, you can press the **<★>** button to lock the ISO speed.
- If you press the **<★>** button and recompose the shot, you can see the exposure level difference on the exposure level indicator (p.22, 258) compared to when the **<★>** button was pressed.
- By pressing the **<INFO.>** button, you can display the histogram.

Information Display

- Each time you press the **<INFO.>** button, the information display will change.

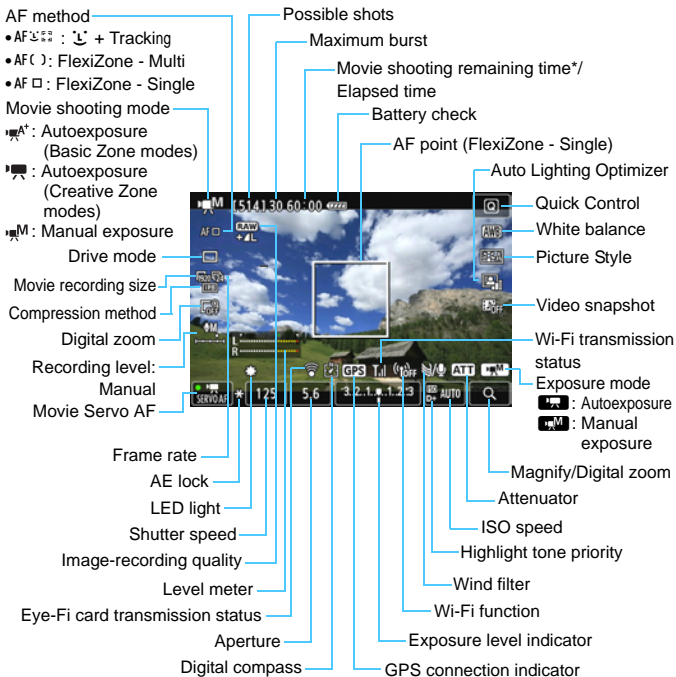

* Applies to a single movie clip.

- You can display the electronic level by pressing the **<INFO.>** button (p.65).
- Note that if the AF method is set to **[AF + Tracking]** or the camera is connected to a TV set with an HDMI cable (p.316), the electronic level cannot be displayed.
- When movie shooting starts, the movie shooting remaining time will change to the elapsed time.

Notes on Movie Shooting



Do not hold the camera in the same position for long periods of time.

Even if the camera does not feel too hot, prolonged contact with the same body part may cause skin redness, blistering or low-temperature contact burns. The use of a tripod is recommended for people with circulation problems or very sensitive skin, or when using the camera in very hot places.



- Do not point the camera toward an intense light source, such as the sun on a sunny day or an intense artificial light source. Doing so may damage the image sensor or the camera's internal components.
- If **<AWB>** is set and the ISO speed or aperture changes during movie shooting, the white balance may also change.
- If you shoot a movie under fluorescent or LED lighting, the movie may flicker.
- Zooming the lens during movie shooting is not recommended. Zooming the lens can cause changes in the exposure regardless of whether the lens' maximum aperture changes or not. Exposure changes may be recorded as a result.
- During movie shooting, you cannot magnify the image even if you press the **<Q>** button.
- Be careful not to cover the microphone (p.252) with your finger, etc.
- **Cautions for movie shooting are on pages 287 and 288.**
- **If necessary, also read the Live View shooting cautions on pages 249 and 250.**



- Movie-related settings are under the **[CAM 1]** and **[CAM 2]** tabs (p.273).
- A movie file is recorded each time you shoot a movie. If the file size exceeds 4 GB, a new file will be created for every subsequent 4 GB.
- The movie image's field of view is approx. 100% (with movie recording size set to **[F1920]**).
- You can also focus the image by pressing the **<AF-ON>** button.
- To focus during movie shooting, press the **<AF-ON>** button. You cannot focus by pressing the shutter button.
- The sound will be recorded in stereo by the camera's built-in microphone.
- Most commercially-available external stereo microphones with a 3.5 mm diameter mini plug can be connected to the camera.

Notes on Movie Shooting



- You can use Remote Controller RC-6 (sold separately, p.184) to start and stop the movie shooting if the drive mode is or . Set the shooting timing switch to <2> (2-sec. delay), then press the transmit button. If the switch is set to (immediate shooting), still photo shooting will take effect.
- With a fully-charged Battery Pack LP-E6, the total movie shooting time will be approx. 1 hr. 20 min. at room temperature (23°C / 73°F) and at low temperatures (0°C / 32°F).
- The focus preset function is possible for movie shooting when using a (super) telephoto lens equipped with the focus preset mode, available since the second half of 2011.

Final Image Simulation

The final image simulation is a function that allows you to see the effects of the Picture Style, white balance, etc., on the image. During movie shooting, the image displayed will automatically reflect the effects of the settings listed below.

Final Image Simulation for Movie Shooting

- Picture Style
 - * All settings such as sharpness, contrast, color saturation, and color tone will be reflected.
- White balance
- White balance correction
- Exposure
- Depth of field
- Auto Lighting Optimizer
- Peripheral illumination correction
- Chromatic aberration correction
- Highlight tone priority

Shooting Still Photos

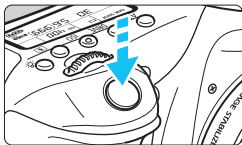

While shooting a movie, you can also take a still photo by pressing the shutter button completely.

Taking Still Photos during Movie Shooting

- If you take a still photo during movie shooting, the movie will record a still moment lasting approx. 1 sec.
- The captured still photo will be recorded to the card, and the movie shooting will resume automatically when the Live View image is displayed.
- The movie and still photo will be recorded as separate files on the card.
- Functions particular to still photo shooting are shown below. Other functions will be the same as for movie shooting.

Function	Settings
Image-recording quality	As set in [1: Image quality]. When the movie recording size is [1920x1080] or [1280x720], the aspect ratio will be 16:9. When the size is [640x480], the aspect ratio will be 4:3.
ISO Speed*	<ul style="list-style-type: none"> • With autoexposure shooting: ISO 100 - ISO 6400. • With manual exposure shooting: See "ISO speed during manual-exposure shooting" on page 257.
Exposure Setting	<ul style="list-style-type: none"> • With autoexposure shooting: Automatically-set shutter speed and aperture. • With manual exposure shooting: Manually-set shutter speed and aperture.



* If highlight tone priority is set, the ISO speed range will start from ISO 200.

- 
 - AEB cannot be used.
 - Even if a flash is used, it will not fire.
 - Continuous still photo shooting is possible during movie shooting. However, the captured images will not be displayed on the screen. Depending on the still photo's image-recording quality, number of shots during continuous shooting, card performance, etc., movie shooting may stop automatically.
 - When you press the <AF-ON> button to autofocus during movie shooting, the following phenomena may occur.
 - Focus may become far off momentarily.
 - The brightness of the recorded movie may be different from that of the actual scene.
 - The recorded movie may be momentarily still.
 - The movie may record the lens operation noise.
 - You cannot shoot still photos when focus is not achieved, such as when the subject is moving.
 - Autofocus will not be performed during movie shooting even if the shutter button is pressed halfway.

- 
 - If you want to shoot still photos continuously during movie shooting, using a high-speed card is recommended. Setting a smaller image-recording quality for still photos and shooting fewer continuous still photos are also recommended.
 - You can shoot still photos in all drive modes.
 - The self-timer can be set before you start shooting a movie. During movie shooting, the camera will switch to single-image shooting.

Shooting Function Settings

AF / DRIVE / ISO Settings

While the movie image is displayed on the LCD monitor, if you press the <AF> or <DRIVE> button, the setting screen will appear on the LCD monitor and you can turn the < > or < > dial to set the respective shooting function.

During manual exposure shooting (p.256), you can press the <ISO> button to set the ISO speed.

Note that metering mode cannot be set.

Q Quick Control

In Creative Zone modes, you can set the **AF method**, **Drive mode**, **Movie recording size**, **Digital zoom**, White balance, Picture Style, Auto Lighting Optimizer, and **Video snapshots**.

In Basic Zone modes, only the functions in bold can be set.



1 Press the <Q> button. (10)

- ▶ The settable functions will be displayed.

2 Select a function and set it.

- Press the <▲▼> key to select a function.
- ▶ The selected function and Feature guide (p.69) will appear.
- Set it by pressing the <◀▶> key.
- To set the Picture Style parameters, press the <INFO.> button.

3 Exit the setting.

- Press <SET> to finalize the setting and return to movie shooting.

MENU Setting the Movie Recording Size



With [**2: Movie rec. size**], you can set the movie's image size, frame rate per second, and compression method. The frame rate switches automatically depending on the [**3: Video system**] setting.

● Image Size

- 1920 [1920x1080]** : Full High-Definition (Full HD) recording quality. The aspect ratio will be 16:9.
- 1280 [1280x720]** : High-Definition (HD) recording quality. The aspect ratio will be 16:9.
- 640 [640x480]** : Standard-definition recording quality. The aspect ratio will be 4:3.





















● Frame Rate (fps: frames per second)

- 30/60** : For areas where the TV format is NTSC (North America, Japan, Korea, Mexico, etc.).
- 25/50** : For areas where the TV format is PAL (Europe, Russia, China, Australia, etc.).
- 24** : Mainly for motion pictures.

● Compression Method

- IPB** IPB : Compresses multiple frames at a time efficiently for recording. Since the file size will be smaller than with ALL-I, you can shoot longer.
- ALL-I** ALL-I (I-only) : Compresses one frame at a time for recording. Although the file size will be larger than with IPB, the movie will be more suited for editing.

Total Movie Recording Time and File Size Per Minute

Movie Recording Size	Total Recording Time (approx.)			File Size (approx.)
	4 GB Card	8 GB Card	16 GB Card	
    	16 min.	32 min.	1 hr. 4 min.	235 MB/min.
	   	5 min.	11 min.	22 min.
   	18 min.	37 min.	1 hr. 14 min.	205 MB/min.
	  	6 min.	12 min.	25 min.
   	48 min.	1 hr. 37 min.	3 hr. 14 min.	78 MB/min.

● Movie Files Exceeding 4 GB

Even if you shoot a movie exceeding 4 GB, you can keep shooting without interruption.

During movie shooting, approx. 30 sec. before the movie reaches the 4 GB file size, the elapsed shooting time or time code displayed in the movie-shooting image will start blinking. If you keep shooting until the movie file size exceeds 4 GB, a new movie file will be created automatically and the elapsed shooting time or time code will stop blinking.

When you play back the movie, you will have to play each movie file individually. Movie files cannot play back consecutively automatically. After the movie playback ends, select the next movie to be played.

● Movie Shooting Time Limit

The maximum recording time of one movie clip is 29 min. 59 sec. If the movie shooting time reaches 29 min. 59 sec., the movie shooting will stop automatically. You can start shooting a movie again by pressing the  button. (A new movie file starts being recorded.)

 An increase of the camera's internal temperature may cause movie shooting to stop before the maximum recording time shown in the table (p.287).

MENU Using Movie Digital Zoom

When the movie size is [1920x1080] (Full HD), you can shoot with an approx. 3x to 10x digital zoom.

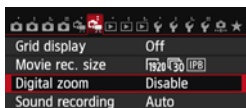

1 Select [Digital zoom].

- Under the [MENU] tab, select [Digital zoom], then press <SET>.

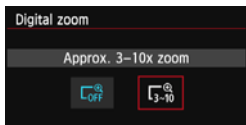

2 Select [Approx. 3-10x zoom].

- Select [Approx. 3-10x zoom], then press <SET>.
- Press the <MENU> button to exit the menu and return to movie shooting.



3 Use digital zoom.

- Press the <▲▼> button.
- The digital zoom bar will appear.
- Press the <▲> key to zoom in or press the <▼> key to zoom out.
- Movie Servo AF will not work.
- When you press the shutter button halfway, the camera will focus with [FlexiZone - Single] (fixed at center).
- To cancel digital zoom, set [Disable] in step 2.



- Use a tripod to prevent camera shake.
- If you use movie digital zoom, contrast-detection AF will be used regardless of the lens used. The AF speed will therefore become slow.
- When movie digital zoom is set, the maximum ISO speed will be ISO 6400 (it cannot be expanded to H: equivalent to ISO 12800). Also, magnified view is not possible.
- Since movie digital zoom processes the image digitally, the image will look rougher at higher magnifications. Noise, light spots, etc., may also become noticeable.
- When movie digital zoom is set, the scene icon will not be displayed.
- Also see "Shooting Conditions that Make Focusing Difficult" on page 241.
- Still photo shooting is not possible.

MENU Setting the Sound Recording

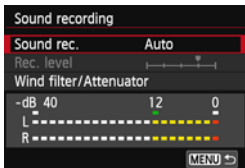

You can shoot movies while recording sound with the built-in stereo microphone or a commercially-available stereo microphone. You can also freely adjust the sound-recording level. Set the sound recording with [CAMERA] 2: **Sound recording**].

Sound Recording/Sound-Recording Level

[Auto] : The sound-recording level is adjusted automatically. Auto level control will operate automatically in response to the sound level.

[Manual] : For advanced users. You can adjust the sound-recording level to one of 64 levels.

Select **[Rec. level]** and look at the level meter while turning the <◉> dial to adjust the sound-recording level. While looking at the peak hold indicator (3 sec.), adjust so that the level meter sometimes lights up the “12” (-12 dB) mark on the right for the loudest sounds. If it exceeds “0”, the sound will be distorted.

[Disable] : Sound will not be recorded.

Wind Filter/Attenuator

[Wind filter] : When **[Enable]** is set, it reduces the wind noise when recording outdoors. This feature takes effect only with the built-in microphone.

Note that **[Enable]** will also reduce low bass sounds, so set this function to **[Disable]** when there is no wind. It will record a more natural sound than with **[Enable]**.

[Attenuator] : Even if **[Sound rec.]** is set to **[Auto]** or **[Manual]** before shooting, sound distortion may still result if there is a very loud sound. In such a case, setting it to **[Enable]** is recommended.

- **Using the Microphone**

The built-in microphone records stereo sound.

Stereo sound recording is also possible by connecting an external stereo microphone (commercially-available) equipped with a miniature stereo plug ($\phi 3.5$ mm) to the camera's external microphone IN terminal (p.20).



- In Basic Zone modes, the settings available for [**Sound recording**] will be [**On/Off**]. If [**On**] is set, the sound-recording level will be adjusted automatically (same as with [**Auto**]), but the wind filter function will not take effect.
- The sound volume balance between L (left) and R (right) cannot be adjusted.
- Both L and R record audio at a 48 kHz/16-bit sampling rate.

MENU Setting the Time Code

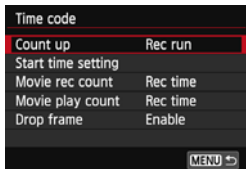

The time code is a time reference recorded automatically to synchronize the video and audio during movie shooting. It is recorded at all times in the following units: hours, minutes, seconds, and frames. It is mainly used during movie editing.

Set the time code with [ 2: Time code].

Count Up

[Rec run] : The time code counts up only while you are shooting a movie.

[Free run] : The time code counts up whether you are shooting or not.

Start Time Setting

You can set the time code's start time.

[Manual input setting] : You can freely set the hour, minute, second, and frames.

[Reset] : The time will be reset to the time set with **[Manual input setting]** and **[Set to camera time]**. It will be "00:00:00." or "00:00:00:" (p.272).

[Set to camera time] : Sets hours, minutes, and seconds to match the camera's internal clock. "Frames" will be set to 00.



- Shooting still photos during movie shooting will cause a discrepancy between the actual time and time code.
- If **[Free run]** is set and you change the time, zone, or daylight saving time (p.37), the time code will be affected.
- The time code is not recorded for video snapshots.



Regardless of the **[Movie rec count]** setting, the time code will always be recorded to the movie file.

Movie Recording Count

You can select what to display on the movie-shooting screen.

[Rec time] : Indicates the elapsed time from the start of the movie shooting.

[Time code] : Indicates the time code during movie shooting.

Movie Playback Count

You can select what to display on the movie playback screen.

[Rec time] : Displays the recording time and playback time during movie playback.

[Time code] : Displays the time code during movie playback.

With **[Time code]** set:

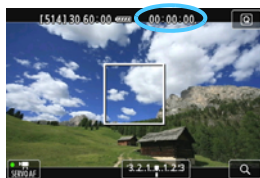

During movie shooting



During movie playback



- If you change the setting for either **[Movie play count]** in **[C1: 2: Time code]** or for **[C2: 3: Movie play count]**, the other setting will also change accordingly.
- “Frames” are not displayed during movie shooting and movie playback.

Drop Frame

If the frame rate setting is $\overline{30}$ (29.97 fps) or $\overline{60}$ (59.94 fps), the time code's frame count causes a discrepancy between the actual time and time code. This discrepancy can be corrected automatically. This correction function is called drop frame.

[Enable] : The discrepancy is corrected automatically by skipping time code numbers (DF: Drop frame).

[Disable] : The discrepancy is not corrected (NDF: Non-drop frame).

The time code will be displayed as follows:

[Enable] (DF) : 00:00:00. (00:00:00.00 during playback)

[Disable] (NDF) : 00:00:00: (00:00:00:00 during playback)

 If the frame rate is $\overline{24}$ (23.98 fps), $\overline{25}$ (25.00 fps), or $\overline{50}$ (50.00 fps), there will be no drop frames. (If $\overline{24}$ is set or if [**3: Video system**] is set to **[PAL]**, the drop frame option will not appear.)

MENU Menu Function Settings

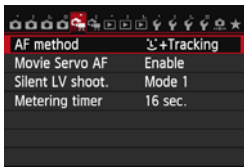

When the Live View shooting/Movie shooting switch is set to <[]>, the [1] and [2] tabs dedicated to movie shooting will be displayed.

● AF method

The AF methods are the same as described on pages 233-242. You can select [+Tracking], [**FlexiZone - Multi**], or [**FlexiZone - Single**].



For movie shooting, [**Quick mode**] cannot be set.

● Movie Servo AF

During movie shooting, the camera focuses the subject continuously. The default setting is [**Enable**].

When [Enable] is set:

- The camera focuses the subject continuously even when you are not pressing the shutter button halfway.
- Since this drives the lens continuously, it will consume battery power and shorten the movie shooting time (p.266).
- With certain lenses, the lens operation noise during focusing may be recorded. To reduce the recording of the lens operation noise, use a commercially-available external microphone. With EF-S18-55mm f/3.5-5.6 IS STM or EF-S18-135mm f/3.5-5.6 IS STM lens, the lens operation noise is less prone to be recorded.
- If you want to set the lens focus mode switch to <MF> during Movie Servo AF, first set the Live View shooting/Movie shooting switch to <[]>.

- If you want to keep the focus at a specific point or you do not want the lens operation noise to be recorded, you can temporarily stop Movie Servo AF as follows. When you stop Movie Servo AF, the AF point will turn gray. When you perform the same steps below, Movie Servo AF will resume.
 - Tap the  icon on the lower left of the screen.
 - Press the <⏏> button.
 - Under [ **C.Fn III-4: Custom controls**], if a button is assigned with [**AF stop**], you can pause the Movie Servo AF while holding down that button. When you let go of the button, Movie Servo AF will resume.
- While Movie Servo AF is paused, pressing the <MENU> or <> button, changing the AF method, or other operation will have Movie Servo AF resume when you resume movie shooting.

When [**Disable**] is set:

- Press the shutter halfway (only before you start movie shooting) or press the <AF-ON> button to focus.



Cautions When [Movie Servo AF] is Set to [Enable]

- **Shooting Conditions that Make Focusing Difficult**
 - A fast-moving subject approaching or moving away from the camera.
 - A subject moving at a close distance in front of the camera.
 - Also see “Shooting Conditions that Make Focusing Difficult” on page 241.
- Movie Servo AF will pause during zooming or magnified view.
- Movie Servo AF will not work during movie digital zooming.
- During movie shooting, if a subject approaches or moves away or if the camera is moved vertically or horizontally (panning), the recorded movie image may momentarily expand or contract (change in image magnification).

- **Silent LV shooting**[★]
This function applies to still photo shooting. For details, see page 231.
- **Metering timer**[★]
You can change how long the exposure setting is displayed (AE lock time).

2

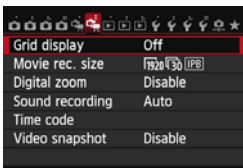

- **Grid display**

With [3x3 

- **Movie recording size**

You can set the movie recording size (image size, frame rate, and compression method). For details, see page 265.

- **Digital zoom**

You can use digital zoom for telephoto shooting. For details, see page 267.

- **Sound recording**

You can set sound-recording settings. For details, see page 268.

- **Time code**

You can set the time code. For details, see page 270.

- **Video snapshot**

You can shoot video snapshots. For details, see page 277.

MENU Shooting Video Snapshots

A video snapshot is a short video clip lasting about 2 sec., 4 sec., or 8 sec. A series of video snapshots can be strung together to form a video snapshot album to show highlights of a trip, event, etc.

A video snapshot album can also be played together with background music (p.284, 309).

Video Snapshot Album Concept

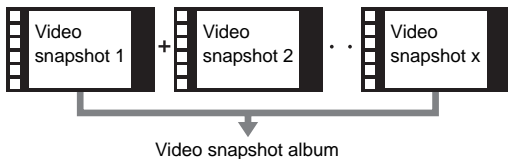

Setting the Video Snapshot Shooting Duration

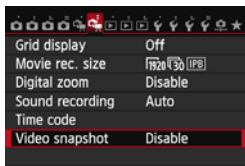

1 Select [Video snapshot].

- Under the [CAM 2] tab, select [Video snapshot], then press <SET>.

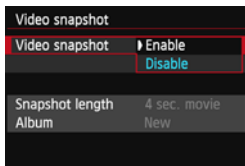

2 Select [Enable].

- Select [Enable], then press <SET>.

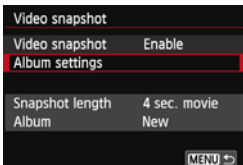

3 Select [Album settings].

- Select [Album settings], then press <SET>.

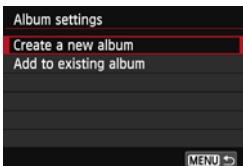

4 Select [Create a new album].

- Select [Create a new album], then press <SET>.

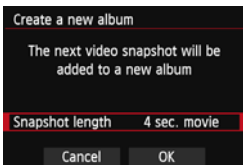

5 Select the snapshot length.

- Press <SET> and use the <▲▼> key to select the snapshot's length, then press <SET>.



Shooting duration

6 Select [OK].

- Select [OK], then press <SET>.
- Press the <MENU> button to exit the menu.
- ▶ A blue bar will appear to indicate the snapshot length.
- Go to "Creating a Video Snapshot Album" (p.279).

Creating a Video Snapshot Album



7 Shoot the first video snapshot.

- Press the <START/STOP> button, then shoot.
- ▶ The blue bar indicating the shooting duration will gradually decrease. After the set shooting duration elapses, the shooting stops automatically.
- ▶ The confirmation dialog will appear (p.280).



8 Save as a video snapshot album.

- Select [**Save as album**], then press <SET>.
- ▶ The movie clip will be saved as the video snapshot album's first video snapshot.



9 Continue to shoot more video snapshots.



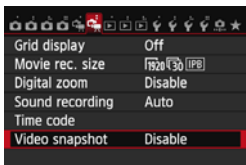



- Repeat step 7 to shoot the next video snapshot.
- Select [**Add to album**], then press <SET>.
- To create another video snapshot album, select [**Save as a new album**].
- If necessary, do step 9 again.













10 Exit the video snapshot shooting.

- Set [**Video snapshot**] to [**Disable**].
To return to normal movie shooting, be sure to set [Disable].
- Press the <MENU> button to exit the menu and return to the normal movie shooting.

Options in Steps 8 and 9

Function	Description
 Save as album (Step 8)	The movie clip will be saved as the video snapshot album's first video snapshot.
 Add to album (Step 9)	The video snapshot just shot will be added to the album recorded immediately before.
 Save as a new album (Step 9)	A new video snapshot album is created and the movie clip is saved as the first video snapshot. The new album will be a different file from the previously recorded album.
 Playback video snapshot (Steps 8 and 9)	The video snapshot just recorded will be played. For playback operations, see the table on the next page.
 Do not save to album (Step 8)  Delete without saving to album (Step 9)	The video snapshot just recorded will be erased instead of being saved to the album. Select [OK] on the confirmation dialog.

[Playback video snapshot] Operations

Function	Playback Description
 Play	By pressing <SET>, you can play or pause the just-recorded video snapshot.
 First frame	Displays the first scene of the album's first video snapshot.
 Skip backward*	Each time you press <SET>, the video snapshot skips back by a few seconds.
 Previous frame	Each time you press <SET>, the previous frame is displayed. If you hold down <SET>, it will rewind the movie.
 Next frame	Each time you press <SET>, the movie will play frame-by-frame. If you hold down <SET>, it will fast forward the movie.
 Skip forward*	Each time you press <SET>, the video snapshot skips forward by a few seconds.
 Last frame	Displays the last scene of the album's last video snapshot.
	Playback position
mm' ss''	Playback time (minutes:seconds)
 Volume	You can adjust the built-in speaker's (p.308) volume by turning the <VOL> dial.
MENU 	Pressing the <MENU> button returns to the previous screen.

* With [**Skip backward**] and [**Skip forward**], the skipping length will correspond to the number of seconds set under [**Video snapshot**] (approx. 2 sec., 4 sec., or 8 sec.).

Adding to an Existing Album

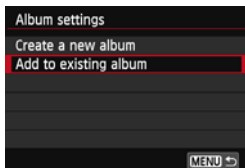

1 Select [Add to existing album].

- Follow step 4 on page 278 to select [Add to existing album], then press <SET>.



2 Select an existing album.

- Turn the <DIAL> dial to select an existing album, then press <SET>.
- Select [OK], then press <SET>.
- ▶ Certain video snapshot settings will change to match the existing album's settings.
- Press the <MENU> button to exit the menu.
- ▶ The video snapshot shooting screen will appear.

3 Shoot the video snapshot.

- Go to "Creating a Video Snapshot Album" (p.279).

 You cannot select an album shot with another camera.



Cautions for Shooting Video Snapshots

- You can add to an album only video snapshots with the same duration (approx. 2 sec., 4 sec., or 8 sec. each).
- Note that if you do any of the following while shooting video snapshots, a new album will be created for subsequent video snapshots.
 - Changing the **[Movie rec. size]**.
 - Changing the **[Sound rec.]** setting from **[Auto/Manual]** to **[Disable]** or from **[Disable]** to **[Auto/Manual]**.
 - Updating the firmware.
- You cannot take still photos while shooting a video snapshot.
- The shooting duration of a video snapshot is only approximate. Depending on the frame rate, the shooting duration displayed during playback may not be exact.

Playing an Album

You can play a video snapshot album in the same way as a normal movie (p.308).



1 Play back the movie.

- Press the <▶> button to display an image.

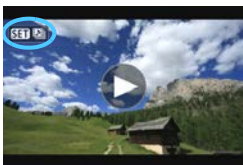

2 Select the album.

- In the single-image display, the [SET] icon displayed on the upper left of the screen indicates a video snapshot album.
- Turn the <⦿> dial to select an album.



3 Play back the album.

- Press <Ⓢ>.
- On the movie playback panel displayed, select [▶] (Play), then press <Ⓢ>.



Background Music

- You can play background music when you play back albums, normal movies, and slide shows on the camera (p.309, 312). To play background music, you must first copy the background music to the card using EOS Utility (provided software). For information on how to copy the background music, refer to the Software Instruction Manual on the CD-ROM.
- Music recorded on the memory card must be used only for private enjoyment. Do not violate the rights of the copyright holder.

Editing an Album

After shooting, you can rearrange, delete, or play back the video snapshots in the album.



1 Select [X].

- On the movie playback panel displayed, select [X] (Edit), then press <SET>.
- The editing screen will be displayed.



2 Select an editing operation.

- Select an editing option, then press <SET>.

Function	Description
↔ Move snapshot	Press the <◀▶> key to select the video snapshot you want to move, then press <SET>. Press the <◀▶> key to move the snapshot, then press <SET>.
🗑 Delete snapshot	Press the <◀▶> key to select the video snapshot you want to delete, then press <SET>. The [🗑] icon will be displayed on the selected video snapshot. Pressing <SET> again will cancel the selection and [🗑] will disappear.
▶ Play snapshot	Press the <◀▶> key to select the video snapshot you want to play, then press <SET>.

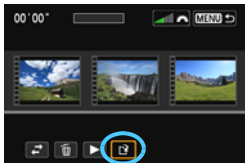

3 Save the edited movie.

- Press the <MENU> button to return to the Editing panel at the screen's bottom.
- Select [**□**] (Save), then press <SET>.
- ▶ The save screen will appear.
- To save it as a new movie, select [**New file**]. To save it and overwrite the original movie file, select [**Overwrite**], then press <SET>.

- If the card does not have enough free space, [**New file**] will not be available.
- When the battery level is low, editing albums is not possible. Use a fully-charged battery.

Provided Software Usable with Albums

- **EOS Video Snapshot Task:** Enables the editing of albums. This add-on function for ImageBrowser EX is automatically downloaded from the Internet using the auto update function.



Movie Shooting Cautions

White <🔥> and Red <🔥> Internal Temperature Warning Icons

- If the camera's internal temperature increases due to prolonged movie shooting or under a high ambient temperature, a white <🔥> or red <🔥> icon will appear.
- The white <🔥> icon indicates that the image quality of still photos will deteriorate. You should stop still photo shooting and allow the camera's internal temperature to cool before shooting again. Since movie image quality will hardly be affected, you can still shoot movies.
- The red <🔥> icon indicates that movie shooting will soon be terminated automatically. If this happens, you will not be able to shoot again until the camera's internal temperature decreases. Turn off the power and let the camera rest for a while.
- Shooting a movie at a high temperature for a prolonged period will cause the <🔥> or <🔥> icon to appear earlier. When you are not shooting, turn off the camera.

Recording and Image Quality

- If the attached lens has an Image Stabilizer and you set the Image Stabilizer (IS) switch to <ON>, the Image Stabilizer will operate at all times even if you do not press the shutter button halfway. The Image Stabilizer consumes battery power and may shorten the total movie shooting time or decrease the number of possible shots. If you use a tripod or if the Image Stabilizer is not necessary, it is recommended to set the IS switch to <OFF>.
- The camera's built-in microphone will also pick up camera operation noise. Using a commercially-available external microphone can prevent (or reduce) these noises from being recorded.
- Do not connect anything other than an external microphone to the camera's external microphone IN terminal.
- If the brightness changes during autoexposure movie shooting, that part may look momentarily still when you play back the movie. In such cases, shoot movies with manual exposure.
- If there is a very bright light source in the picture, the bright area may appear black on the LCD monitor. The movie will be recorded in almost the same way you see it on the LCD monitor.
- In low light, noise or irregular colors may appear in the image. The movie will be recorded in almost the same way you see it on the LCD monitor.

Movie Shooting Cautions

Recording and Image Quality

- If you use a card with a slow writing speed, a five-level indicator may appear on the right of the screen during movie shooting. It indicates how much data has not yet been written to the card (remaining capacity of the internal buffer memory). The slower the card, the faster the indicator will climb upward. If the indicator becomes full, movie shooting will stop automatically.

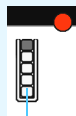

Indicator

If the card has a fast writing speed, the indicator will either not appear or the level (if displayed) will hardly go upward. First, shoot a few test movies to see if the card can write fast enough.

Still Photo Shooting during Movie Shooting

- Regarding the image quality of still photos, see “Image Quality” on page 249.

Playback and TV connection

- If you connect the camera to a TV set (p.316, 319) and shoot a movie, the TV will not output any sound during the shooting. However, the sound will be properly recorded.

9

Image Playback

This chapter explains how to play back and erase photos and movies, how to display them on a TV screen, and other playback-related functions.

Images shot and saved with another device

The camera may not be able to properly display images captured with a different camera, edited with a computer, or that have had their file names changed.

▶ Image Playback

Single-Image Display



1 Play back the image.

- Press the <▶> button.
- ▶ The last captured image or last image played back will appear.



2 Select an image.

- To play back images starting with the last image, turn the <◻> dial counterclockwise.
- To play back images starting with the first captured image, turn the dial clockwise.
- Each time you press the <INFO.> button, the display format will change.



No information



With basic information

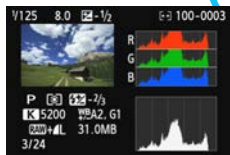

Histogram

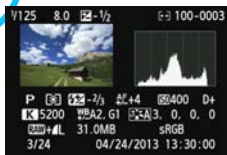

Shooting information display

3 Exit the image playback.

- Press the <▶> button to exit the image playback and return to shooting-ready state.

MENU Grid Display

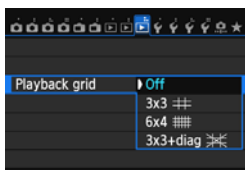

On the single-image display, you can overlay a playback grid.

With [**▶3: Playback grid**], you can select [**3x3** , [**6x4** , or [**3x3+diag** ].

This function is convenient for checking the image's vertical or horizontal tilt, as well as composition.



The grid is not displayed during movie playback.

INFO.: Shooting Information Display

Sample Still Photo Taken in a Creative Zone Mode

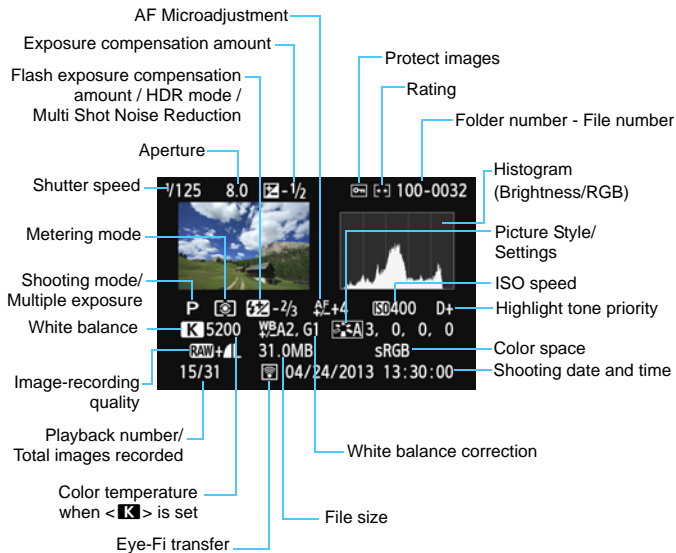

- * When you shoot in RAW+JPEG image quality, the RAW image file size will be displayed.
- * During flash photography without flash exposure compensation, $\langle \text{f} \rangle$ will be displayed.
- * $\langle \text{HDR} \rangle$ and the dynamic range adjustment amount will be displayed for images taken in the HDR mode.
- * $\langle \text{ME} \rangle$ will be displayed for multiple-exposure photos.
- * $\langle \text{NR} \rangle$ will be displayed for images shot with Multi Shot Noise Reduction.
- * For still photos taken during movie shooting, $\langle \text{M} \rangle$ will be displayed.
- * For images developed with the camera's RAW processing function, resized, or processed with a Creative filter and then saved, $\langle \text{CF} \rangle$ will be displayed.

Sample Still Photo Taken in a Basic Zone Mode

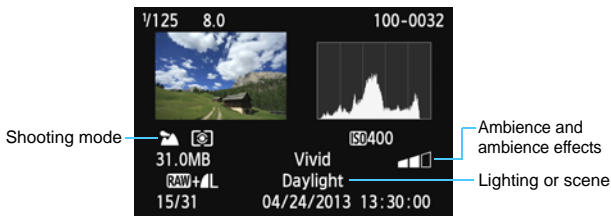

- * With images taken in a Basic Zone mode, the information displayed will differ depending on the shooting mode.
- * [**Background blur**] will be displayed for images taken in the <[CA]> mode.

Sample Movie Information Display

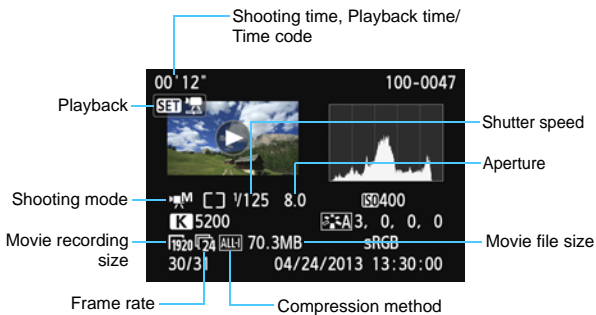

- * If manual exposure was used, the shutter speed, aperture, and ISO speed (when set manually) will be displayed.
- * The <[M]> icon will be displayed for video snapshots.

- **Highlight Alert**

When [ **3: Highlight alert**] is set to [**Enable**], overexposed highlight areas will blink. To obtain more image detail in the overexposed, blinking areas, set the exposure compensation to a negative amount and shoot again.

- **AF Point Display**

When [ **3: AF point disp.**] is set to [**Enable**], the AF point that achieved focus will be displayed in red. If automatic AF point selection was used, multiple AF points may be displayed at the same time.

● Histogram

The brightness histogram shows the exposure level distribution and overall brightness. The RGB histogram is for checking the color saturation and gradation. The display can be switched with [**▶** 3: Histogram disp.].

[Brightness] Display

This histogram is a graph showing the distribution of the image's brightness level. The horizontal axis indicates the brightness level (darker on the left and brighter on the right), while the vertical axis indicates how many pixels exist for each brightness level. The more pixels there are toward the left, the darker the image. The more pixels there are toward the right, the brighter the image. If there are too many pixels on the left, the shadow detail will be lost. If there are too many pixels on the right, the highlight detail will be lost. The gradation in-between will be reproduced. By checking the image and its brightness histogram, you can see the exposure level inclination and the overall gradation.

Sample Histograms



Dark image



Normal brightness



Bright image

[RGB] Display

This histogram is a graph showing the distribution of each primary color's brightness level in the image (RGB or red, green, and blue). The horizontal axis indicates the color's brightness level (darker on the left and brighter on the right), while the vertical axis indicates how many pixels exist for each color brightness level. The more pixels there are toward the left, the darker and less prominent the color. The more pixels there are toward the right, the brighter and denser the color. If there are too many pixels on the left, the respective color information will be lacking. If there are too many pixels on the right, the color will be too saturated with no gradation. By checking the image's RGB histogram, you can see the color's saturation and gradation condition, as well as white balance inclination.

▶ Searching for Images Quickly

❑ Display Multiple Images on One Screen (Index Display)

Search for images quickly with the index display showing four or nine images on one screen.



1 Switch to the index display.

- During image playback, press the <❑·Q> button.
- ▶ The 4-image index display will appear. The selected image is highlighted in an orange frame.
- Press the <❑·Q> button again to switch to the 9-image display. Pressing the <Q> button will switch the display from 9 images to 4 images and then to 1 image.

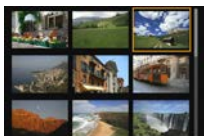

2 Select an image.



- Turn the <☉> dial to move the orange frame and select the image. You can also press the <▲▼> <◀▶> keys to select the image.
- Turning the <☉> dial will display image(s) on the next or previous screen.
- Press <ⓈET> in the index display to display the selected image as a single image.

Jump through Images (Jump Display)

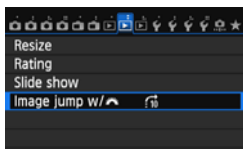

In the single-image display, you can turn the  dial to jump through the images forward or backward according to the jump method set.



1 Select [Image jump w/].

- Under the [ 2] tab, select [Image jump w/ ], then press < >.

2 Select the jump method.

- Turn the < > dial to select the jump method, then press < >.

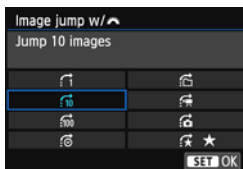

: Display images one by one

: Jump 10 images

: Jump 100 images

: Display by date

: Display by folder

: Display movies only

: Display stills only

: Display by image rating (p.302)



Turn the < > dial to select.



Jump method

Playback position

3 Browse by jumping.

- Press the < > button to play back images.
- In the single-image display, turn the < > dial.
- ▶ You can browse by the method that was set.





- To search images according to the shooting date, select [Date].
- To search images according to folder, select [Folder].
- If the card contains both movies and still photos, select [Movies] or [Stills] to display only one or the other.
- If no images match the selected [Rating], you cannot browse through the images with the < > dial.

Magnified View

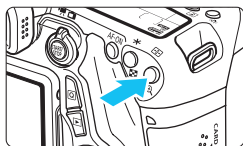
You can magnify a captured image by approx. 1.5x to 10x on the LCD monitor.



1 Magnify the image.



- Press the  button during image playback.
- ▶ The image will be magnified.
- If you hold down the  button, the image will be magnified until it reaches the maximum magnification.
- Press the  button to reduce the magnification. If you hold down the button, the magnification will be reduced to the single-image display.



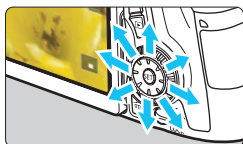

Magnified area position



2 Scroll around the image.

- Use  to scroll around the magnified image.
- To exit magnified view, press the  button and the single-image display will reappear.



-  ● You can turn the  dial to view another image while the magnification is maintained.
- Magnified view is not possible during the image review immediately after the image is taken.
- A movie cannot be magnified.

Playing Back with the Touch Screen

The LCD monitor is a touch-sensitive panel that you can touch with your fingers for various playback operations. **First, press the <▶> button to play back images.**

Browsing Images



Swipe with one finger.

- With single-image display, touch the LCD monitor with **one finger**. You can browse to the next or previous image by swiping your finger to the left or right. Swipe left to see the next (newer) images or swipe right to see previous (older) images.
- With index display, also touch the LCD monitor with **one finger**. You can browse to the next or previous screen by swiping your finger up or down.

Swipe up to see the next (newer) images or swipe down to see the previous (older) images.

When you select an image, the orange frame will appear. Tap the image again to display it as a single image.

Jumping through Images (Jump Display)

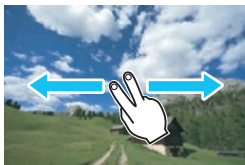

Swipe with two fingers.

Touch the LCD monitor with two fingers. When you swipe **two fingers** to the left or right, you can jump through images with the method set in [Image jump w/ ] under the [▶2] tab.

Reducing Image (Index Display)



Pinch two fingers.

Touch the screen with two fingers spread apart, then pinch your fingers together on the screen.

- Each time you pinch your fingers, the screen changes from a single-image display to a 4-image index display and 9-image index display. If you spread your fingers, the image display will change in the reverse order.
- When you select an image, the orange frame will appear. Tap the image again to display it as a single image.

Magnifying Image



Spread two fingers apart.

Touch the screen with two fingers together, then spread your fingers apart on the screen.

- As you spread your fingers, the image will be magnified.
- The image can be magnified up to 10x.
- You can scroll around the image by dragging your finger.
- To reduce the image, pinch your fingers together on the screen.
- Tapping the [↶] icon will return to the single-image display.



 Touch screen operations on the camera's LCD monitor are also possible while playing back images on a TV set connected to your camera (p.316, 319).

Rotating the Image

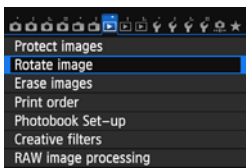
You can rotate the displayed image to the desired orientation.



1 Select [Rotate image].

- Under the [ 1] tab, select [Rotate image], then press < >.



2 Select an image.



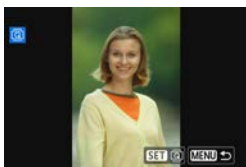



- Turn the < > dial to select the image to be rotated.
- You can also select an image in the index display (p.296).



3 Rotate the image.

- Each time you press < >, the image will rotate clockwise as follows: 90° → 270° → 0°.
- To rotate another image, repeat steps 2 and 3.
- To return to the menu, press the <MENU> button.



- If you have set [ 1: Auto rotate] to [On  ] (p.325) before taking vertical shots, you need not rotate the image as described above.
- If the rotated image is not displayed in the rotated orientation during image playback, set [ 1: Auto rotate] to [On  ].
- A movie cannot be rotated.

MENU Setting Ratings

You can rate images (still photos and movies) with one of five rating marks: [★]/[★]/[★]/[★]/[★]. This function is called rating.

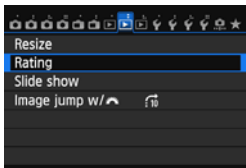

1 Select [Rating].

- Under the [▶]2 tab, select [Rating], then press <SET>.



2 Select an image.

- Turn the <◉> dial to select the image or movie to be rated.
- To display the three-image display, press the <[grid]-Q> button. To return to the single-image display, press the <Q> button.



3 Rate the image.

- Press the <▲▼> key to select a rating.
- ▶ The total number of images rated will be counted for each rating.
- To rate another image, repeat steps 2 and 3.
- To return to the menu, press the <MENU> button.













The total number of images with a given rating that can be displayed is up to 999. If there are more than 999 images with a given rating, [###] will be displayed for that rating.

Taking Advantage of Ratings

- With [**▶2: Image jump w/** ], you can display only images with a specific rating.
- With [**▶2: Slide show**], you can play back only images with a specific rating.
- With Digital Photo Professional (provided software, p.456), you can select only images with a specific rating (still photos only).
- With Windows 7 or Windows Vista, etc., you can see each file's rating as part of the file information display or in the provided image viewer (still photos only).

Quick Control for Playback

During single-image display, you can press the  button to set any of the following: [: **Protect images**, : Rotate image, : **Rating**, : Creative filters, : Resize (JPEG image only), : **Highlight alert**, : **AF point display**, : **Image jump w/** , (): **Wi-Fi***].

For movies, only the functions in bold above can be set.

* Not selectable if [ **3: Wi-Fi**] is set to [Disable].

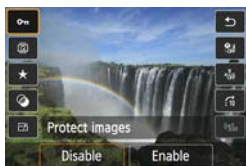





1 Press the button.

- During image playback, press the  button.
- ▶ The Quick Control options will appear.









2 Select a function and set it.

- Press the  key to select a function.
- ▶ The setting of the selected function is displayed at the bottom.
- Press the  key to change it.
- When setting the Creative filters (p.335), Resize (p.333), or Wi-Fi function, also press  to finalize the setting.
- Image jump w/ : Set the Rating (p.297) by pressing the **<INFO.>** button.
- To cancel, press the **<MENU>** button.

3 Exit the setting.

- Press the  button to exit the Quick Control screen.

 To rotate an image, set [**⚙1: Auto rotate**] to [**On**  ]. If [**⚙1: Auto rotate**] is set to [**On** ] or [**Off**], the [**Ⓚ Rotate image**] setting will be recorded to the image, but the camera will not rotate the image for display.

-  • Pressing the <> button during the index display will switch to the single-image display and the Quick Control screen will appear. Pressing the <> button again will return to the index display.
- For images taken with another camera, the options you can select may be limited.

Enjoying Movies

You can play back movies in the following three ways:

Playback on a TV Set (p.316, 319)



Use the HDMI cable HTC-100 (sold separately) or stereo AV cable AVC-DC400ST (sold separately) to connect the camera to a TV set. Then you can play back captured movies and still photos on TV.

If you have a High-Definition TV set and connect your camera with an HDMI cable, you can watch Full High-Definition (Full HD: 1920x1080) and High-Definition (HD: 1280x720) movies with higher image quality.

- Since hard disk recorders do not have an HDMI IN terminal, the camera cannot be connected to a hard disk recorder with an HDMI cable.
- Even if the camera is connected to a hard disk recorder with a USB cable, movies and still photos cannot be played nor saved.
- If the playback device is not compatible with MOV files, the movie cannot be played.

Playback on the Camera's LCD Monitor (p.308-315)



You can play back movies on the camera's LCD monitor. You can also edit out the movie's first and last scenes, and play back the still photos and movies on the card in an automatic slide show.

- A movie edited with a computer cannot be rewritten to the card and played back with the camera. However, video snapshot albums edited with EOS Video Snapshot Task (p.286) can be played on the camera.

Playback and Editing with a Computer (p.456)



The movie files recorded on the card can be transferred to a computer and played with ImageBrowser EX (provided software).

- To have the movie play back smoothly on a computer, use a high-performance computer. Regarding the computer hardware requirements for ImageBrowser EX, refer to the PDF file ImageBrowser EX User Guide.
- If you want to use commercially-available software to play back or edit the movies, be sure it is compatible with MOV files. For details on commercially-available software, contact the software manufacturer.

▶ Playing Movies



1 Play back the image.

- Press the <▶> button to display an image.



2 Select a movie.

- Turn the <◉> dial to select the movie to be played.
- In the single-image display, the <SET [camera]> icon displayed on the upper left of the screen indicates a movie. If the movie is a video snapshot, <SET [snapshot]> will be displayed.
- In the index display, perforations at the left edge of a thumbnail indicate a movie. **As movies cannot be played from the index display, press <SET> to switch to the single-image display.**



3 In the single-image display, press <SET>.

- ▶ The movie playback panel will appear at the bottom of the screen.



4 Play back the movie.





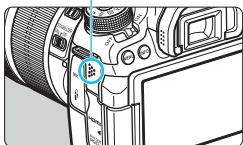







- Select [▶] (Play), then press <SET>.
- ▶ The movie will start playing.
- You can pause the movie playback by pressing <SET>.
- You can adjust the sound volume by turning the <◉> dial even during movie playback.
- For more details on the playback procedure, see the next page.

Speaker



ⓘ The camera may not be able to play movies shot with another camera.

Movie Playback Panel

Operation	Playback Description
 Play	Pressing <SET> toggles between play and stop.
 Slow motion	Adjust the slow motion speed by pressing the <◀▶> key. The slow motion speed is indicated at the upper right of the screen.
 First frame	Displays the movie's first frame.
 Previous frame	Each time you press <SET>, the previous frame is displayed. If you hold down <SET>, it will rewind the movie.
 Next frame	Each time you press <SET>, the movie will play frame-by-frame. If you hold down <SET>, it will fast forward the movie.
 Last frame	Displays the movie's last frame.
 Background music*	Plays back a movie with the selected background music (p.315).
 Edit	Displays the editing screen (p.310).
	Playback position
mm' ss"	Playback time (minutes:seconds with [Movie play count: Rec time] set)
hh:mm:ss.ff (DF) hh:mm:ss:ff (NDF)	Time code (hours:minutes:seconds:frames with [Movie play count: Time code] set)
 Volume	You can adjust the built-in speaker's (p.308) volume by turning the <◀▶> dial.
 MENU 	Pressing the <MENU> button returns to the single-image display.

* When background music is set, the movie's sound will not be played.



- With a fully-charged Battery Pack LP-E6, the continuous playback time at room temperature (23°C / 73°F) will be as follows: approx. 4 hours.
- If you connect the camera to a TV set to play a movie (p.316, 319), adjust the sound volume with the TV set. (Turning the <◀▶> dial will not change the sound volume.)
- If you took a still photo while you shot the movie, the still photo will be displayed for approx. 1 sec. during the movie playback.

Playback with the Touch Screen

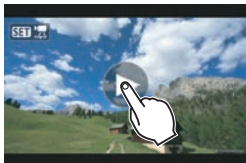

Tap [▶] at the center of the screen.

- ▶ The movie will start playing.
- To display the movie playback panel, tap <SET [SET] [SET]> on the upper left of the screen.
- To pause the movie while it is playing, tap the screen. The movie playback panel will also appear.

✂ Editing a Movie's First and Last Scenes

You can edit out the first and last scenes of a movie in approx. 1-sec. increments.



1 On the movie playback screen, select [✂].

- ▶ The movie editing panel will be displayed at the bottom of the screen.



2 Specify the part to be edited out.

- Select either [✂] (Cut beginning) or [□] (Cut end), then press <SET>.
- Press the <◀▶> key to see the previous or next frames. Holding it down will fast forward the frames. Turn the <⌚> dial for frame-by-frame playback.
- After deciding which part to edit out, press <SET>. The portion highlighted in gray on the top of the screen is what will remain.





3 Check the edited movie.

- Select [▶] and press <SET> to play back the edited movie.
- To change the editing, go back to step 2.
- To cancel the editing, press the <MENU> button, then select [OK] on the confirmation screen.



4 Save the edited movie.

- Select [💾], then press <SET>.
- ▶ The save screen will appear.
- To save it as a new movie, select [New file]. To save it and overwrite the original movie file, select [Overwrite], then press <SET>.
- On the confirmation screen, select [OK], then press <SET> to save the edited movie and return to the movie playback screen.



- Since the editing is performed in approx. 1-sec. increments (position indicated by [✂] on the top of the screen), the actual position where the movie is edited may differ from the position you specified.
- If the card does not have enough free space, [New file] will not be available.
- When the battery level is low, movie editing is not possible. Use a fully-charged battery.

MENU Slide Show (Auto Playback)

You can play back the images on the card as an automatic slide show.

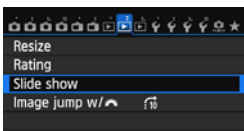

1 Select [Slide show].

- Under the [▶] 2 tab, select [Slide show], then press <SET>.

Number of images to be played

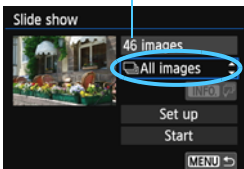

2 Select the images to be played.

- Press the <▲▼> key to select the desired option, then press <SET>.

[All images]/[Movies]/[Stills]

- Press the <▲▼> key to select one of the following: [📁 All images]/ [🎞 Movies]/ [📷 Stills]. Then press <SET>.

[Date]/[Folder]/[Rating]

- Press the <▲▼> key to select one of the following: [📅 Date]/ [📁 Folder]/ [★ Rating].
- When <INFO. [INFO.]> is highlighted, press the <INFO.> button.
- Press the <▲▼> key to select the desired option, then press <SET>.

[Date]



[Folder]



[Rating]

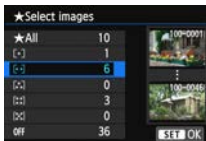

Item	Playback Description
All images	All the still photos and movies on the card will be played back.
Date	Still photos and movies taken on the selected shooting date will be played back.
Folder	Still photos and movies in the selected folder will be played back.
Movies	Only the movies on the card will be played back.
Stills	Only the still photos on the card will be played back.
Rating	Only the still photos and movies with the selected rating will be played back.

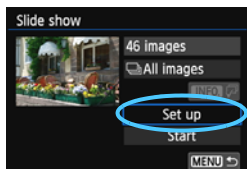

3 Set [Set up] as desired.

- Press the <▲▼> key to select [**Set up**], then press <SET>.
- Set the [**Display time**], [**Repeat**] (repeated playback), [**Transition effect**] (effect when changing images), and [**Background music**] for the still photos.
- The background music selection procedure is explained on page 315.
- After selecting the settings, press the <MENU> button.

[Display time]

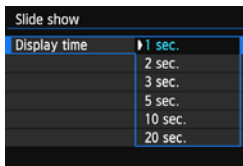

[Repeat]

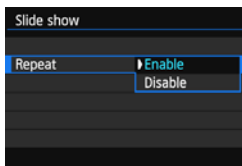

[Transition effect]

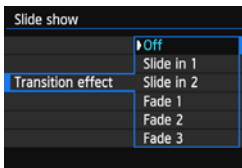

[Background music]

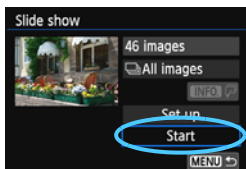
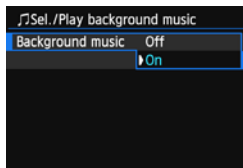

4 Start the slide show.

- Press the <▲▼> key to select [Start], then press <SET>.
- ▶ After [Loading image...] is displayed, the slide show will start.

5 Exit the slide show.

- To exit the slide show and return to the setting screen, press the <MENU> button.

- To pause the slide show, press <SET>. During pause, [III] will be displayed on the upper left of the image. Press <SET> again to resume the slide show.
- During auto playback, you can press the <INFO.> button to change the still photo display format (p.290).
- During movie playback, you can adjust the sound volume by turning the <🔊> dial.
- During auto playback or pause, you can turn the <🕒> dial to view another image.
- During auto playback, auto power off will not work.
- The display time may vary depending on the image.
- To view the slide show on a TV set, see page 316.

Selecting the Background Music

After you use EOS Utility (provided software) to copy background music to the card, you can play background music together with the slide show.



1 Select [Background music].

- Set [Background music] to [On], then press <SET>.
- If the card has no background music, you cannot perform step 2.

2 Select the background music.

- Press the <▲▼> key to select the desired background music, then press <SET>. You can also select multiple background music tracks.

3 Play the background music.

- To listen to a sample of the background music, press the <INFO.> button.
- Press the <▲▼> key to play another background music track. To stop listening to the background music, press the <INFO.> button again.
- Adjust the sound volume by turning the <◀▶> dial.
- To delete a background music track, press the <▲▼> key and select the track, then press the <🗑️> button.



Upon purchase, the camera does not have background music. The procedure to copy background music to a card is explained in the EOS Utility instruction manual on the CD-ROM.

Viewing Images on a TV Set

You can view still photos and movies on a TV set.

Viewing on High-Definition (HD) TV Sets (Connected with HDMI)

HDMI Cable HTC-100 (sold separately) is required.

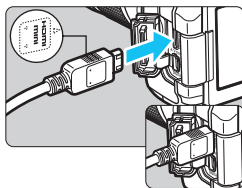

1 Connect the HDMI cable to the camera.

- With the plug's <▲HDMI MINI> logo facing the front of the camera, insert it into the <HDMI OUT> terminal.

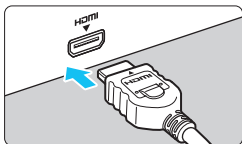

2 Connect the HDMI cable to the TV set.

- Connect the HDMI cable to the TV's HDMI IN port.

3 Turn on the TV and switch the TV's video input to select the connected port.

4 Set the camera's power switch to <ON>.

- Adjust movie sound volume with the TV set. The sound volume cannot be adjusted with the camera.
- Before connecting or disconnecting the cable between the camera and TV set, turn off the camera and TV set.
- Depending on the TV set, part of the image displayed may be cut off.

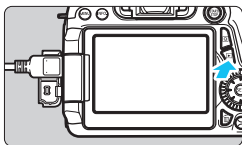

5 Press the <▶> button.

- ▶ The image will appear on the TV screen. (Nothing will be displayed on the camera's LCD monitor.)
- The images will automatically be displayed at the TV's optimum resolution.
- By pressing the <INFO.> button, you can change the display format.
- To play back movies, see page 308.



The images cannot be output at the same time from both the <HDMI OUT> and <A/V OUT> terminals.



- Do not connect any other device's output to the camera's <HDMI OUT> terminal. Doing so may cause a malfunction.
- Certain TVs may not be able to display the captured movies. In such a case, use the stereo AV cable AVC-DC400ST (sold separately) to connect to the TV.

Using HDMI CEC TV Sets

If the TV set connected to the camera with an HDMI cable is compatible with HDMI CEC*, you can use the TV set's remote control for playback operations.

* An HDMI-standard function enabling HDMI devices to control each other so that you can control them with one remote control unit.

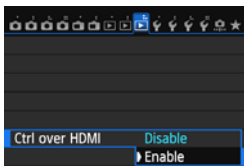

1 Set [Ctrl over HDMI] to [Enable].

- Under the [▶3] tab, select [Ctrl over HDMI], then press <SET>.
- Select [Enable], then press <SET>.

2 Connect the camera to a TV set.

- Use an HDMI cable to connect the camera to the TV.
- ▶ The TV's input will switch automatically to the HDMI port connected to the camera.

3 Press the camera's <▶> button.

- ▶ An image will appear on the TV screen and you can use the TV's remote control to play back images.

4 Select an image.

- Point the remote control toward the TV set and press the ←/→ button to select an image.

5 Press the remote control's Enter button.

- ▶ The menu appears and you can perform the playback operations shown on the left.
- Press the ←/→ button to select the desired option, then press the Enter button. For a slide show, press the remote control's ↑/↓ button to select an option, then press the Enter button.
- If you select **[Return]** and press the Enter button, the menu will disappear and you can use the ←/→ button to select an image.

Still photo playback menu



Movie playback menu



- ↶ : Return
- ☐☐☐ : 9-image index
- 🎬 : Play movie
- 🔄 : Slide show
- INFO. : Disp. shooting info
- 🔄 : Rotate

- Some TV sets require you to first enable the HDMI CEC connection. For details, refer to the TV set's instruction manual.
- Certain TV sets, even those compatible with HDMI CEC, may not operate properly. In such a case, set [**▶**3: **Ctrl over HDMI**] to [**Disable**], and use the camera to control the playback operation.

Viewing on Non-HD TV Sets (Connected with AV Cable)

Stereo AV Cable AVC-DC400ST (sold separately) is required.

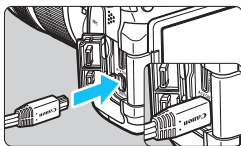

1 Connect the AV cable to the camera.

- With the plug's <Canon> logo facing the back of the camera, insert it into the <A/V OUT> terminal.

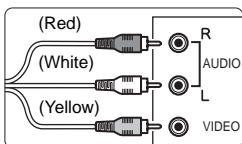

2 Connect the AV cable to the TV set.

- Connect the AV cable to the TV's video IN terminal and audio IN terminals.

3 Turn on the TV and switch the TV's video input to select the connected port.

4 Set the camera's power switch to <ON>.

5 Press the <▶> button.

- ▶ The image will appear on the TV screen. (Nothing will be displayed on the camera's LCD monitor.)
- To play back movies, see page 308.

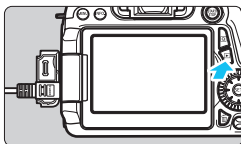



- Do not use any AV cable other than the Stereo AV cable AVC-DC400ST (sold separately). Movies may not be displayed if you use a different cable.
- If the video system format does not match the TV's, the movies will not be displayed properly. If this happens, switch to the proper video system format with [**F3: Video system**].

Protecting Images

Protecting an image prevents it from being erased accidentally.

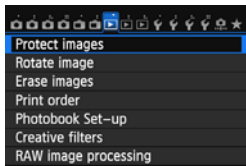
MENU Protecting a Single Image



- 1 Select [Protect images].**
 - Under the [ 1] tab, select [**Protect images**], then press < >.

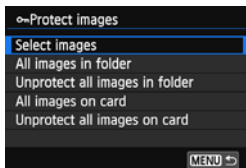







- 2 Select [Select images].**
 - Select [**Select images**], then press < >.
 - An image will be displayed.

Image protect icon



- 3 Protect the image.**
 - Turn the < > dial to select the image to be protected, then press < >.
 - The image will be protected, and the < > icon will appear at the top of the screen.
 - To cancel the image protection, press < > again. The < > icon will disappear.
 - To protect another image, repeat step 3.
 - To return to the menu, press the <**MENU**> button.

MENU Protecting All Images in a Folder or on a Card

You can protect all the images in a folder or on a card at one time.

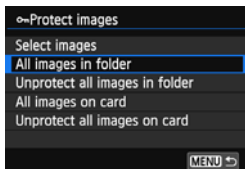

When you select **[All images in folder]** or **[All images on card]** in [▶ 1: **Protect images**], all the images in the folder or on the card will be protected. To cancel the image protection, select **[Unprotect all images in folder]** or **[Unprotect all images on card]**.

 **If you format the card (p.57), the protected images will also be erased.**

-  ● Movies can also be protected.
- Once an image is protected, it cannot be erased by the camera's erase function. To erase a protected image, you must first cancel the protection.
- If you erase all the images (p.323), only the protected images will remain. This is convenient when you want to erase unnecessary images all at once.

Erasing Images

You can either select and erase unnecessary images one by one or erase them in one batch. Protected images (p.320) will not be erased.

- 1 **Once an image is erased, it cannot be recovered. Make sure you no longer need the image before erasing it. To prevent important images from being erased accidentally, protect them. Erasing a RAW+JPEG image will erase both the RAW and JPEG images.**

Erasing a Single Image



- 1 **Play back the image to be erased.**

- 2 **Press the  button.**

- ▶ The Erase menu will appear at the bottom of the screen.

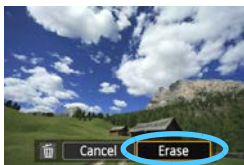

- 3 **Erase the image.**



- Select **[Erase]**, then press . The image displayed will be erased.

MENU Checkmarking Images to Be Erased in a Batch

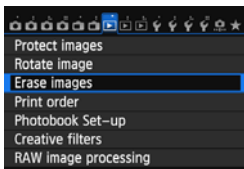
By appending checkmarks  to the images to be erased, you can erase multiple images at one time.



- 1 **Select **[Erase images]**.**

- Under the **[ 1]** tab, select **[Erase images]**, then press .

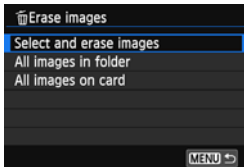

2 Select [Select and erase images].

- Select [Select and erase images], then press <SET>.
- ▶ An image will be displayed.
- To display the three-image display, press the <DISP> button. To return to the single-image display, press the <Q> button.



3 Select the images to be erased.

- Turn the <DISP> dial to select the image to be erased, then press <SET>.
- ▶ A checkmark <✓> will be displayed on the upper left of the screen.
- To select other images to be erased, repeat step 3.

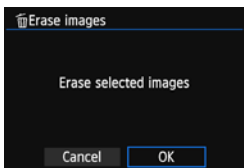

4 Erase the image.

- Press the <DISP> button.
- Select [OK], then press <SET>.
- ▶ The selected images will be erased.

MENU Erasing All Images in a Folder or on a Card

You can erase all the images in a folder or on a card at one time. When [▶ 1: Erase images] is set to [All images in folder] or [All images on card], all the images in the folder or on the card will be erased.

 To also erase protected images, format the card (p.57).

Changing Image Playback Settings

MENU Adjusting the LCD Monitor Brightness

You can adjust the brightness of the LCD monitor to make it easier to read.

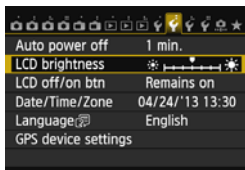

1 Select [LCD brightness].

- Under the [**2**] tab, select [**LCD brightness**], then press <SET>.

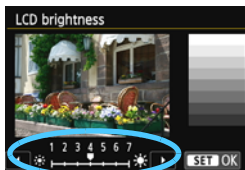

2 Adjust the brightness.

- While referring to the gray chart, press the <◀▶> key, then press <SET>.

 To check the image's exposure, looking at the histogram is recommended (p.295).

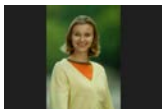
MENU Auto Rotation of Vertical Images

Vertical images are rotated automatically so they are displayed vertically on the camera's LCD monitor and on the computer instead of horizontally. You can change the setting for this feature.

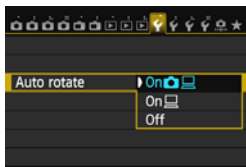
**1** Select **[Auto rotate]**.

- Under the [**1**] tab, select **[Auto rotate]**, then press **<SET>**.

2 Set the auto rotation.

- Select the desired setting, then press **<SET>**.

- On**  

The vertical image is automatically rotated during playback on both the camera's LCD monitor and on the computer.

- On** 

The vertical image is automatically rotated only on the computer.

- Off**

The vertical image is not automatically rotated.



Auto rotation will not work with vertical images captured while auto rotation was **[Off]**. They will not rotate even if you later switch it to **[On]** for playback.



- Immediately after image capture, the vertical image will not be automatically rotated for the image review.
- If the vertical image is taken while the camera is pointed up or down, the image may not be rotated automatically for playback.
- If the vertical image is not automatically rotated on the computer screen, it means the software you are using is unable to rotate the image. Using the provided software is recommended.

10

Post-Processing Images

You can process RAW images with the camera, resize (reduce the pixel count of) JPEG images, and apply Creative filters.

- The ☆ icon at the upper right of the page title indicates that the function is available only in Creative Zone modes (**P/Tv/Av/M/B**).



- The camera may not be able to process images taken with another camera.
- Post-processing images as described in this chapter is not possible if the camera is set for multiple exposures, or while it is connected to a computer via the <DIGITAL> terminal.

RAW/JPEG ↓ Processing RAW Images with the Camera ☆

You can process **RAW** images with the camera and save them as JPEG images. While the RAW image itself does not change, you can process the RAW image according to different conditions to create any number of JPEG images from it.

Note that **M RAW** and **S RAW** images cannot be processed with the camera. Use Digital Photo Professional (provided software, p.456) to process those images.

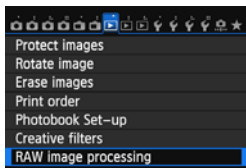

1 Select [RAW image processing].

- Under the [▶] 1 tab, select [**RAW image processing**], then press <SET>.
- ▶ **RAW** images will be displayed.



2 Select an image.

- Turn the <◉> dial to select the image you want to process.
- By pressing the <☒+Q> button, you can switch to the index display and select an image.



3 Process the image.

- Press <SET> and then the RAW-processing options will appear (p.330).
- Press the <▲▼> <◀▶> keys to select an option, then turn the <◉> dial to change the setting.
- ▶ The displayed image will reflect “Brightness adjustment”, “White balance”, and the other setting adjustments.
- To return to the image settings at the time of shooting, press the <INFO.> button.



Displaying the setting screen

- Press <SET> to display the setting screen. Turn the <DISP> or <DISP/ON/OFF> dial to change the setting. To finalize the change and return to the screen in step 3, press <SET>.



4 Save the image.

- Select [] (Save), then press <SET>.
- Select [OK] to save the image.
- Check the destination folder and image file number, then select [OK].
- To process another image, repeat steps 2 to 4.
- To return to the menu, press the <MENU> button.

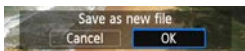

Magnified View

You can magnify the image by pressing the <Q> button in step 3. The magnification will differ depending on the pixel count of **[Image quality]** set in **[RAW image processing]**. With <DISP>, you can scroll around the magnified image.







To cancel magnified view, press the <DISP/Q> button.

Images with Aspect Ratio Setting

Images shot in an aspect ratio (p.229) of **[4:3]**, **[16:9]**, or **[1:1]** will be displayed in the respective aspect ratio. JPEG images will also be saved in the set aspect ratio.

When Wi-Fi function is used, RAW image processing cannot be performed.

RAW Image Processing Options

-  **Brightness adjustment**
You can adjust the image brightness up to ± 1 stop in 1/3-stop increments. The displayed image will reflect the setting's effect.
-  **Picture Style** (p.126)
You can select the Picture Style. Press the <◀▶> key to select the Picture Style. To set the parameters such as sharpness, press the <INFO.> button to display the setting screen. Press the <▲▼> key to select a parameter to be adjusted, then press the <◀▶> key to change it. To finalize the setting and return to the screen in step 3, press <SET>. The displayed image will reflect the setting's effect.
-  **White balance** (p.134)
You can select the white balance. If you select [**K**], turn the <☀️> dial to set the color temperature on the setting screen. The displayed image will reflect the setting's effect.
-  **Auto Lighting Optimizer** (p.140)
You can set the Auto Lighting Optimizer. The displayed image will reflect the setting's effect.
-  **High ISO speed noise reduction** (p.141)
You can set the noise reduction for high ISO speeds. The displayed image will reflect the setting's effect. If the effect is difficult to discern, magnify the image (p.329).
-  **Image quality** (p.116)
You can set the image quality when converting an image to JPEG format. The image size displayed, such as [*****M ***x*****], has a 3:2 aspect ratio. The pixel count of each aspect ratio is indicated in the table on page 334.

- sRGB **Color space** (p.155)
You can select either sRGB or Adobe RGB. Since the camera's LCD monitor is not compatible with Adobe RGB, the image will not look very different when either color space is set.
- OFF **Peripheral illumination correction** (p.146)
If [**Enable**] is set, the corrected image will be displayed. If the effect is difficult to discern, magnify the image (p.329) and check the four corners. The peripheral illumination correction applied with the camera will be less pronounced than with Digital Photo Professional (provided software) and may be less apparent. In such a case, use Digital Photo Professional to apply the peripheral illumination correction.
- OFF **Chromatic aberration correction** (p.147)
When [**Enable**] is set, the lens' chromatic aberrations (color fringing along the subject's outline) can be corrected. If [**Enable**] is set, the corrected image will be displayed. If the effect is difficult to discern, magnify the image (p.329).
- OFF **Distortion correction**
When [**Enable**] is set, image distortion due to the lens characteristics is corrected. If [**Enable**] is set, the corrected image will be displayed. The image periphery will be cropped in the corrected image.
Since the image resolution may look slightly lower, use the Picture Style's sharpness parameter to make adjustments as necessary.

ⓘ Peripheral Illumination Correction, Distortion Correction, and Chromatic Aberration Correction

To execute peripheral illumination correction, distortion correction, and chromatic aberration correction with the camera, the data of the lens used for the shot must be registered in the camera. If the lens data has not been registered in the camera, use EOS Utility (provided software, p.456) to register the lens data.

- ⓘ ● Processing RAW images in the camera will not produce the same results as processing RAW images with Digital Photo Professional.
- When processing images with [**Distortion correction**] set to [**Enable**], AF point display information (p.294) and Dust Delete Data (p.341) will not be appended to the image.

Resizing JPEG Images

You can resize an image to make the pixel count lower and save it as a new image. Resizing an image is possible only with JPEG L/M/S1/S2 images. **JPEG S3 and RAW images cannot be resized.**

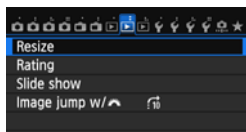



1 Select [Resize].

- Under the [ 2] tab, select [Resize], then press <SET>.
- ▶ An image will be displayed.





2 Select an image.

- Turn the < > dial to select the image you want to resize.
- By pressing the <- > button, you can switch to the index display and select an image.



Target sizes

3 Select the desired image size.

- Press <SET> to display the image sizes.
- Press the <- > key to select the desired image size, then press <SET>.



4 Save the image.

- Select [OK] to save the resized image.
- Check the destination folder and image file number, then select [OK].
- To resize another image, repeat steps 2 to 4.
- To return to the menu, press the <MENU> button.

Resize Options According to Original Image Size

Original Image Size	Available Resize Settings			
	M	S1	S2	S3
L	<input type="radio"/>	<input type="radio"/>	<input type="radio"/>	<input type="radio"/>
M		<input type="radio"/>	<input type="radio"/>	<input type="radio"/>
S1			<input type="radio"/>	<input type="radio"/>
S2				<input type="radio"/>

Image Sizes

The image size displayed in step 3 on the preceding page, such as [***M ***x***], has a 3:2 aspect ratio. The image size according to aspect ratios is shown in the table below.

The asterisked image-recording quality figures do not exactly match the aspect ratio. The image will be cropped slightly.

Image Quality	Aspect Ratio and Pixel Count (Approx.)			
	3:2	4:3	16:9	1:1
M	3648x2432 (8.9 megapixels)	3248x2432* (7.9 megapixels)	3648x2048* (7.5 megapixels)	2432x2432 (5.9 megapixels)
S1	2736x1824 (5.0 megapixels)	2432x1824 (4.4 megapixels)	2736x1536* (4.2 megapixels)	1824x1824 (3.3 megapixels)
S2	1920x1280 (2.5 megapixels)	1696x1280* (2.2 megapixels)	1920x1080 (2.1 megapixels)	1280x1280 (1.6 megapixels)
S3	720x480 (350,000 pixels)	640x480 (310,000 pixels)	720x408* (290,000 pixels)	480x480 (230,000 pixels)



 When Wi-Fi function is used, resizing is not possible.

Applying Creative Filters

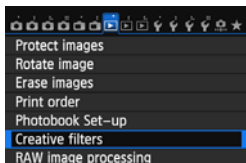
You can apply the following Creative filters to an image and save it as a new image: Grainy B/W, Soft focus, Fish-eye effect, Art bold effect, Water painting effect, Toy camera effect, and Miniature effect.





1 Select [Creative filters].

- Under the [] tab, select [Creative filters], then press <  >.
- ▶ An image will be displayed.





2 Select an image.

- Turn the <  > dial to select the image you want to apply a filter to.
- By pressing the <  > button, you can switch to the index display and select an image.







3 Select a filter.

- When you press <  >, the types of Creative filters will be displayed (p.336).
- Press the <  > key to select a filter, then press <  >.
- ▶ The image will be displayed with the corresponding filter applied.



4 Adjust the filter effect.

- Press the <  > key to adjust the filter effect, then press <  >.
- For the Miniature effect, press the <  > key and select the image area (within the white frame) where you want the image to look sharp, then press <  >.

 While Wi-Fi is used, Creative filters cannot be applied.

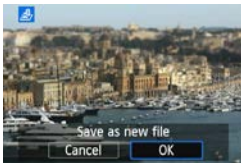

5 Save the image.

- Select [**OK**] to save the image.
- Check the destination folder and image file number, then select [**OK**].
- To apply a filter to another image, repeat steps 2 to 5.
- To return to the menu, press the <**MENU**> button.

- When shooting **RAW**+JPEG images, the Creative filter will be applied to the **RAW** image and the image will be saved as a JPEG image.
- When shooting **M RAW**+JPEG or **S RAW**+JPEG images, the Creative filter will be applied to the JPEG image.
- During Live View shooting, if an aspect ratio was set for a **RAW** image and a Creative filter is applied to it, the image will be saved in the aspect ratio that was set.

Creative Filter Characteristics

- **Grainy B/W**
Creates a grainy black-and-white photo. You can change the black-and-white effect by adjusting the contrast.
- **Soft focus**
Gives the image a soft look. You can change the degree of softness by adjusting the blur.

-  **Fish-eye effect**

Gives the effect of a fish-eye lens. The image will have a barrel-type distortion.

Depending on the level of this filter effect, the area trimmed along the periphery of the image changes. Also, since this filter effect will magnify the image center, the apparent resolution at the center may degrade depending on the number of recorded pixels. Set the filter effect in step 4 while checking the resulting image.

-  **Art bold effect**

Makes the photo look like an oil painting and the subject look three-dimensional. You can adjust the contrast and saturation. Note that the sky, white walls, and similar subjects may not be rendered with a smooth gradation and may look irregular or have significant noise.

-  **Water painting effect**

Makes the photo look like a watercolor painting with soft colors. You can adjust the color density. Note that night scenes or dark scenes may not be rendered with a smooth gradation and may look irregular or have significant noise.

-  **Toy camera effect**

Darkens the photo's corners and applies a color tone that makes it look as if it was shot by a toy camera. You can change the color cast by adjusting the color tone.

-  **Miniature effect**

Creates a diorama effect. You can change where the image looks sharp. In step 4, if you press the <INFO.> button (or tap on [] at the screen's bottom), you can switch between the white frame's vertical and horizontal orientations.

11

Sensor Cleaning

The camera has a Self Cleaning Sensor Unit to automatically shake off dust adhered to the image sensor's front layer (low pass filter). The Dust Delete Data can also be appended to the image so that the dust spots remaining can be erased automatically by Digital Photo Professional (provided software, p.456).

Smudges adhering to the front of the sensor

Besides dust entering the camera from outside, in rare cases lubricant from the camera's internal parts may adhere to the front of the sensor. If visible spots still remain after the automatic sensor cleaning, having the sensor cleaned by a Canon Service Center is recommended.



Even while the Self Cleaning Sensor Unit is operating, you can press the shutter button halfway to interrupt the cleaning and start shooting immediately.

Automatic Sensor Cleaning

Whenever you set the power switch to <ON> or <OFF>, the Self Cleaning Sensor Unit operates to automatically shake off the dust on the front of the sensor. Normally, you need not pay attention to this operation. However, you can choose to perform sensor cleaning at any time, or disable it.

Cleaning the Sensor Now

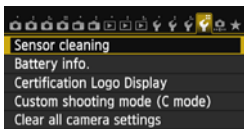

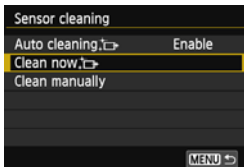

1 Select [Sensor cleaning].

- Under the [**4**] tab, select [**Sensor cleaning**], then press <SET>.



2 Select [Clean now].

- Select [**Clean now **], then press <SET>.
- Select [**OK**], then press <SET>.
- ▶ The screen will indicate that the sensor is being cleaned. (A small sound may be heard.) Although there will be a shutter sound, no picture is taken.

- For best results, perform the sensor cleaning with the camera placed upright and stable on a table or other flat surface.
- Even if you repeat the sensor cleaning, the result will not improve much. Immediately after the sensor cleaning is finished, the [**Clean now **] option will remain disabled temporarily.

Disabling Automatic Sensor Cleaning

- In step 2, select [**Auto cleaning **] and set it to [**Disable**].
- ▶ The sensor cleaning will no longer be executed when you set the power switch to <ON> or <OFF>.

MENU Appending Dust Delete Data ☆

Normally, the Self Cleaning Sensor Unit will eliminate most of the dust that may be visible on captured images. However, in case visible dust still remains, you can append the Dust Delete Data to the image for erasing the dust spots later. The Dust Delete Data is used by Digital Photo Professional (provided software, p.456) to erase the dust spots automatically.

Preparation

- Prepare a solid white object such as a sheet of paper.
- Set the lens focal length to 50 mm or longer.
- Set the lens focus mode switch to <MF> and set the focus to infinity (∞). If the lens has no distance scale, look at the front of the lens and turn the focusing ring clockwise all the way.

Obtaining the Dust Delete Data

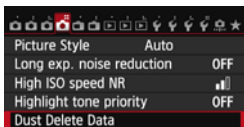

1 Select [Dust Delete Data].

- Under the [CAMERA] tab, select [Dust Delete Data], then press <SET>.

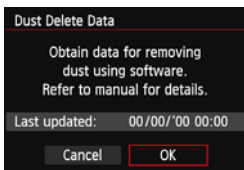

2 Select [OK].

- Select [OK] and press <SET>. After the automatic self-cleaning of the sensor is performed, a message will appear. Although there will be a shutter sound during the cleaning, no picture is taken.

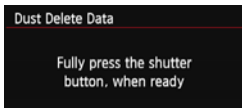
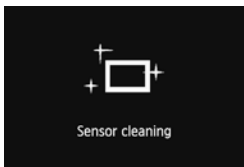



3 Shoot a solid-white object.

- At a distance of 20 cm - 30 cm (0.7 ft. - 1.0 ft.), fill the viewfinder with a patternless, solid-white object and take a picture.
- ▶ The picture will be taken in aperture-priority AE mode at an aperture of f/22.
- Since the image will not be saved, the data can still be obtained even if there is no card in the camera.
- ▶ When the picture is taken, the camera will start collecting the Dust Delete Data. When the Dust Delete Data is obtained, a message will appear. Select **[OK]** and the menu will reappear.
- If the data was not obtained successfully, an error message will appear. Follow the “Preparation” procedure on the preceding page, then select **[OK]**. Take the picture again.

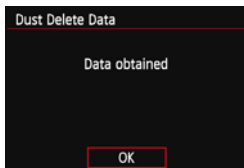

Dust Delete Data

After the Dust Delete Data is obtained, it is appended to all the JPEG and RAW images captured thereafter. Before an important shoot, it is recommended to update the Dust Delete Data by obtaining it again. For details about using Digital Photo Professional (provided software, p.456) to erase dust spots, refer to the Software Instruction Manual (p.459) on the CD-ROM.

The Dust Delete Data appended to the image is so small that it hardly affects the image file size.

! Be sure to use a solid-white object such as a new sheet of white paper. If the object has any pattern or design, it may be recognized as dust data and affect the accuracy of the dust deletion with the software.

MENU Manual Sensor Cleaning ☆

Dust that could not be removed by the automatic sensor cleaning can be removed manually with a commercially-available blower, etc. Before cleaning the sensor, detach the lens from the camera.

The surface of the image sensor is extremely delicate. If the sensor needs to be cleaned directly, having it done by a Canon Service Center is recommended.

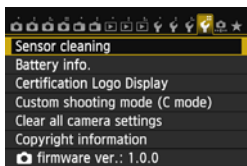

1 Select [Sensor cleaning].

- Under the [4] tab, select [Sensor cleaning], then press <SET>.

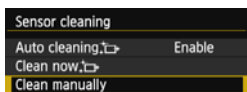

2 Select [Clean manually].

- Select [Clean manually], then press <SET>.

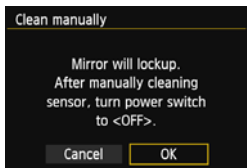

3 Select [OK].

- Select [OK], then press <SET>.
- ▶ In a moment, the reflex mirror will lockup and the shutter will open.
- "CLn" will blink on the LCD panel.

4 Clean the sensor.

5 End the cleaning.

- Set the power switch to <OFF>.

 If you use a battery, make sure it is fully charged. If the battery grip with size-AA/LR6 batteries is attached, manual sensor cleaning will not be possible.

 For the power source, using AC Adapter Kit ACK-E6 (sold separately) is recommended.

- **While cleaning the sensor, never do any of the following. If the power is cut off, the shutter will close and the shutter curtains and image sensor may get damaged.**
 - **Setting the power switch to <OFF>.**
 - **Removing or inserting the battery.**
- The surface of the image sensor is extremely delicate. Clean the sensor with care.
- Use a plain blower without any brush attached. A brush can scratch the sensor.
- Do not insert the blower tip inside the camera beyond the lens mount. If the power is turned off, the shutter will close and the shutter curtains or reflex mirror may get damaged.
- Never use pressurized air or gas to clean the sensor. The blowing force can damage the sensor or the spray gas can freeze on the sensor and scratch it.
- If the battery level becomes low while you clean the sensor, the beeper will sound as a warning. Stop cleaning the sensor.
- If a smudge that cannot be removed with a blower remains, having the sensor cleaned by a Canon Service Center is recommended.

12

Printing Images

- **Printing** (p.348)
You can connect the camera directly to a printer and print out the images on the card. The camera is compatible with “PictBridge”, which is the standard for direct printing. You can also use a wireless LAN to send images to a PictBridge (DPS over IP) printer and print them. For details, refer to the Wi-Fi Function Instruction Manual.
- **Digital Print Order Format (DPOF)** (p.355)
DPOF (Digital Print Order Format) enables you to print images recorded on the card according to your printing instructions such as the image selection, quantity to print, etc. You can print multiple images in one batch or give the print order to a photofinisher.
- **Specifying Images for a Photobook** (p.359)
You can specify images on the card for printing in a photobook.

Preparing to Print

The direct printing procedure can be performed entirely with the camera while you look at the camera's LCD monitor.

Connecting the Camera to a Printer

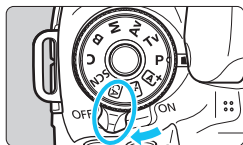

- 1 Set the camera's power switch to <OFF>.

- 2 Set up the printer.

- For details, refer to the printer's instruction manual.

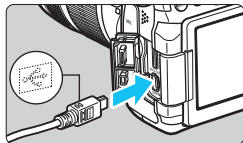

- 3 Connect the Camera to the Printer.

- Use the interface cable provided with the camera.
- Connect the cable to the camera's <DIGITAL> terminal with the cable plug's <DIGITAL> icon facing the front of the camera.
- To connect to the printer, refer to the printer's instruction manual.

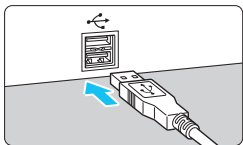

- 4 Turn on the printer.

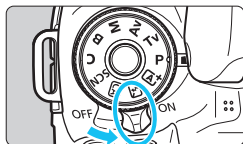

- 5 Set the camera's power switch to <ON>.

- ▶ Some printers may make a beeping sound.

PictBridge



6 Play back the image.

- Press the <▶> button.
- ▶ The image will appear, with the <PictBridge icon> on the upper left of the screen to indicate that the camera is connected to a printer.



- Make sure the printer has a PictBridge connection port.
- Movies cannot be printed.
- The camera cannot be used with printers compatible only with CP Direct or Bubble Jet Direct.
- Do not use any interface cable other than the one provided.
- If there is a long beeping sound in step 5, it indicates a problem with the printer. Resolve the problem displayed in the error message (p.354).
- Printing is not possible when shooting mode is set to <P> or <A>, Multi Shot Noise Reduction is set, or HDR mode is set.
- If [4: Wi-Fi] is set to [Enable], direct printing is not possible. Set it to [Disable], then connect the interface cable.



- You can also print RAW images taken with this camera.
- If you use a battery pack to power the camera, make sure it is fully charged. With a fully-charged battery, printing up to approx. 4 hours is possible.
- Before disconnecting the cable, first turn off the camera and printer. Hold the plug (not the cord) to pull out the cable.
- For direct printing, using AC Adapter Kit ACK-E6 (sold separately) to power the camera is recommended.

☞ Printing

The screen display and setting options will differ depending on the printer. Some settings may not be available. For details, refer to the printer's instruction manual.

Printer-connected icon



1 Select the image to be printed.

- Check that the <☞> icon is displayed on the upper left of the LCD monitor.
- Turn the <⊙> dial to select the image to be printed.

2 Press <SET>.

- ▶ The print setting screen will appear.

Print setting screen

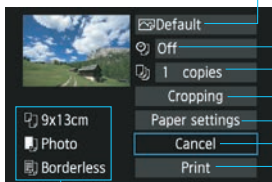

Sets the printing effects (p.350).

Sets the date or file number imprinting to on or off (p.351).

Sets the quantity to be printed (p.351).

Sets the print area (p.353).

Sets the paper size, type, and layout (p.349).

Returns to the screen in step 1.

Starts the printing.

The paper size, type, and layout you have set are displayed.

* Depending on the printer, certain settings such as the date and file number imprinting and cropping may not be selectable.

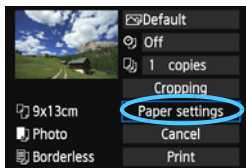

3 Select [Paper settings].

- Select [Paper settings], then press <⊙>.
- ▶ The paper settings screen will appear.

Setting the Paper Size

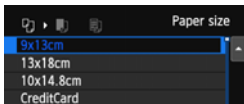

- Select the size of the paper loaded in the printer, then press **<SET>**.
- ▶ The paper type screen will appear.

Setting the Paper Type

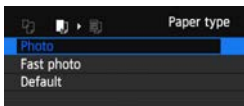

- Select the type of the paper loaded in the printer, then press **<SET>**.
- ▶ The page layout screen will appear.

Setting the Page Layout

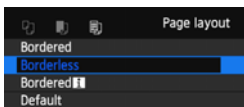

- Select the page layout, then press **<SET>**.
- ▶ The print setting screen will reappear.

Bordered	The print will have white borders along the edges.
Borderless	The print will have no borders. If your printer cannot print borderless prints, the print will have borders.
Bordered [i]	The shooting information* ¹ will be imprinted on the border on 9x13 cm or larger prints.
xx-up	Option to print 2, 4, 8, 9, 16, or 20 images on one sheet.
20-up [i] 35-up [i]	20 or 35 images will be printed as thumbnails on A4 or Letter size paper* ² . • [20-up [i]] will have the shooting information* ¹ imprinted.
Default	The page layout will vary depending on the printer model or its settings.

*1: From the Exif data, the camera name, lens name, shooting mode, shutter speed, aperture, exposure compensation amount, ISO speed, white balance, etc., will be imprinted.

*2: After ordering the prints with "Digital Print Order Format (DPOF)" (p.355), printing by following "Direct Printing of Print-Ordered Images" (p.358) is recommended.

If the image's aspect ratio is different from the printing paper's aspect ratio, the image may be cropped significantly when you print it as a borderless print. If the image is cropped, it may look grainier on the paper due to the fewer number of pixels.

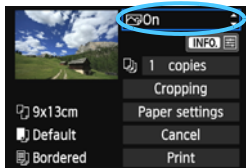

4 Set the printing effects.

- Set them if necessary. If you do not need to set any printing effects, go to step 5.
- **What is displayed on the screen differs depending on the printer.**
- Select the option, then press <SET>.
- Select the desired printing effect, then press <SET>.
- If the <INFO> and <MENU> icons are displayed brightly, you can also adjust the printing effect (p.352).

Printing Effect	Description
On	The image will be printed using the printer's standard colors. The image's Exif data is used to make automatic corrections.
Off	No automatic correction will be applied.
VIVID	The image will be printed with higher saturation to produce more vivid blues and greens.
NR	Image noise is reduced before printing.
B/W B/W	Prints in black-and-white with true blacks.
B/W Cool tone	Prints in black-and-white with cool, bluish blacks.
B/W Warm tone	Prints in black-and-white with warm, yellowish blacks.
Natural	Prints the image in the actual colors and contrast. No automatic color adjustments are applied.
Natural M	The printing characteristics are the same as the "Natural" setting. However, this setting enables finer printing adjustments than with "Natural."
Default	The printing will differ depending on the printer. For details, refer to the printer's instruction manual.

* When you change the printing effects, changes are reflected in the image displayed on the upper left of the screen. Note that the printed image may look slightly different from the displayed image, which is only an approximation. This also applies to [Brightness] and [Adjust levels] on page 352.

If the shooting information of an image shot at the "H" ISO speed is imprinted, the correct ISO speed may not be imprinted.

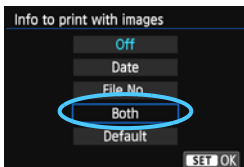

5 Set the date and file number imprinting.

- Set them if necessary.
- Select <☺>, then press <SET>.
- Set the print settings as desired, then press <SET>.

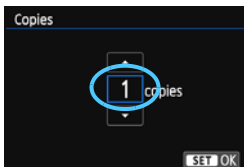

6 Set the number of copies.

- Set it if necessary.
- Select <☺>, then press <SET>.
- Select the number of copies, then press <SET>.

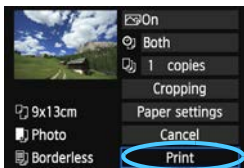

7 Start printing.

- Select [Print], then press <SET>.



- The [Default] setting for printing effects and other options are the printer's own default settings as set by the printer's manufacturer. Refer to the printer's instruction manual to find out what the [Default] settings are.
- Depending on the image's file size and image-recording quality, it may take some time for the printing to start after you select [Print].
- If image tilt correction (p.353) is applied, it may take longer to print the image.
- To stop the printing, press <SET> while [Stop] is displayed, then select [OK].
- If you execute [4: Clear all camera settings] (p.61), all the settings will revert to their defaults.

Adjustment of Printing Effects

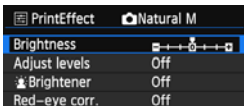
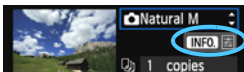

In step 4 on page 350, select the printing effect. When the  icon is displayed brightly next to **<INFO>**, you can press the **<INFO.>** button. You can then adjust the printing effect. What can be adjusted or what is displayed will depend on the selection made in step 4.

Brightness

The image brightness can be adjusted.

Adjust levels

When you select **[Manual]**, you can change the histogram's distribution and adjust the image's brightness and contrast.

With the Adjust levels screen displayed, press the **<INFO.>** button to change the position of the **<I>**. Press the **<◀▶>** key to freely adjust the shadow level (0-127) or highlight level (128-255).



Brightener

Effective in backlit conditions that can make the subject's face look dark. When **[On]** is set, the face will be brightened for printing.

Red-eye corr.

Effective in flash images where the subject has red eye. When **[On]** is set, the red eye will be corrected for printing.

-  The **[Brightener]** and **[Red-eye corr.]** effects will not be reflected on the screen.
- When **[Detail set.]** is selected, you can adjust the **[Contrast]**, **[Saturation]**, **[Color tone]**, and **[Color balance]**. To adjust the **[Color balance]**, use **<◉>**. B is for blue, A for amber, M for magenta, and G for green. The image's color balance will be corrected towards the selected color.
- If you select **[Clear all]**, all the printing effect settings will be reverted to their defaults.

Cropping the Image

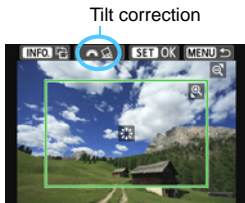



You can crop the image and print only an enlarged version of the cropped portion, as if the image had been recomposed.

Set the cropping right before printing. If you change the print settings after setting the cropping, you may have to set the cropping again before printing.

- 1 On the print setting screen, select **[Cropping]**.
- 2 Set the cropping frame size, position, and aspect ratio.
 - The image area within the cropping frame will be printed. The cropping frame's aspect ratio can be changed with **[Paper settings]**.

Changing the Cropping Frame Size

When you press the  or  button, the size of the cropping frame will change. The smaller the cropping frame, the larger the image magnification will be for printing.



Moving the Cropping Frame

Use  to move the frame over the image vertically or horizontally. Move the cropping frame until it covers the desired image area.

Rotating the Frame

Pressing the **<INFO.>** button will toggle the cropping frame between the vertical and horizontal orientations. This enables you to create a vertically oriented print from a horizontal image.

Image Tilt Correction

By turning the  dial, you can adjust the image tilt angle up to ± 10 degrees in 0.5-degree increments. When you adjust the image tilt, the  icon on the screen will turn blue.

- 3 Press **<SET>** to exit the cropping.
 - ▶ The print setting screen will reappear.
 - You can check the cropped image area on the upper left of the print setting screen.

- Depending on the printer, the cropped image area may not be printed as you specified.
- The smaller you make the cropping frame, the grainier the picture will look in the print.
- While cropping the image, look at the camera's LCD monitor. If you look at the image on a TV screen, the cropping frame may not be displayed accurately.



Handling Printer Errors

If you resolve a printer error (no ink, no paper, etc.) and select [**Continue**] to resume printing but it does not resume, operate the buttons on the printer to resume printing. For details on resuming the printing, refer to the printer's instruction manual.

Error Messages

If a problem occurs during printing, an error message will appear on the camera's LCD monitor. Press < (SET) > to stop printing. After fixing the problem, resume printing. For details on how to fix a printing problem, refer to the printer's instruction manual.

Paper Error

Check whether the paper is properly loaded in the printer.

Ink Error

Check the printer's ink level and the waste ink tank.

Hardware Error

Check for any printer problems other than paper and ink problems.

File Error

The selected image cannot be printed via PictBridge. Images taken with a different camera or images edited with a computer may not be printable.

Digital Print Order Format (DPOF)

You can set the print type, date imprinting, and file number imprinting. The print settings will be applied to all print-ordered images. (They cannot be set individually for each image.)

Setting the Printing Options

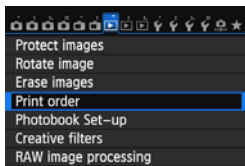

1 Select [Print order].

- Under the [▶] 1 tab, select [Print order], then press <SET>.

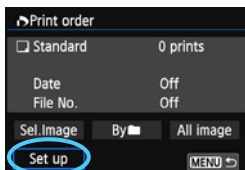

2 Select [Set up].

- Select [Set up], then press <SET>.

3 Set the option as desired.

- Set the [Print type], [Date], and [File No.].
- Select the option to be set, then press <SET>. Select the desired setting, then press <SET>.

[Print type]

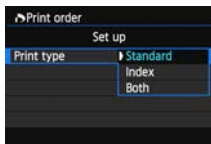



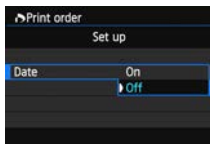

[Date]

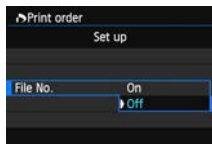

[File No.]



Print type		Standard	Prints one image on one sheet.
		Index	Multiple thumbnail images are printed on one sheet.
	 	Both	Prints both the standard and index prints.
Date	On	[On] imprints the recorded date on the print.	
	Off		
File number	On	[On] imprints the file number on the print.	
	Off		

4 Exit the setting.

- Press the <MENU> button.
- ▶ The print order screen will reappear.
- Next, select [**Sel.Image**], [**By** ], or [**All image**] to order the images to be printed.

- Even if [**Date**] and [**File No.**] are set to [**On**], the date or file number may not be imprinted depending on the print type setting and printer model.
- With [**Index**] prints, the [**Date**] and [**File No.**] cannot both be set to [**On**] at the same time.
- When printing with DPOF, use the card whose print order specifications have been set. It will not work if you just extract images from the card and try to print them.
- Certain DPOF-compatible printers and photofinishers may not be able to print the images as you specified. Refer to the printer's instruction manual before printing, or check with your photofinisher about compatibility when ordering prints.
- Do not insert into the camera a card whose print order was set by a different camera and then try to specify a print order. The print order may be overwritten. Also, depending on the image type, the print order may not be possible.

 RAW images and movies cannot be print ordered. You can print RAW images with PictBridge (p.345).

Print Ordering

Sel.Image

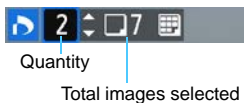
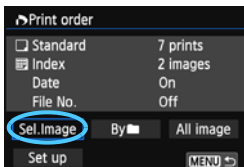

Select and order images one by one. To display the three-image display, press the <☒·Q> button. To return to the single-image display, press the <Q> button.

Press the <MENU> button to save the print order to the card.

[Standard] [Both]

Press the <▲▼> key to set the number of copies to be printed for the displayed image.

[Index]

Press <SET> to add a checkmark to the box <✓>. The image will be included in the index print.

By

Select [**Mark all in folder**] and select the folder. A print order for one copy of all the images in the folder will be placed. If you select [**Clear all in folder**] and select the folder, the print order for that folder will all be canceled.

All image

If you select [**Mark all on card**], one copy of all the images on the card will be set for printing. If you select [**Clear all on card**], the print order will be cleared for all the images on the card.



- Note that RAW images and movies will not be included in the print order even if you set [**By**] or [**All image**].
- When using a PictBridge printer, print no more than 400 images for one print order. If you specify more than this, all the images may not be printed.

Direct Printing of Print-Ordered Images

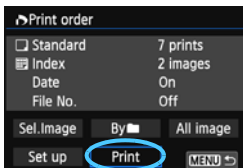

With a PictBridge printer, you can easily print images with DPOF.

1 Prepare to print.

- See page 346.

Follow the “Connecting the Camera to a Printer” procedure up to step 5.

2 Under the [1] tab, select [Print order].

3 Select [Print].

- [Print] will be displayed only if the camera is connected to a printer and printing is possible.

4 Set the [Paper settings] (p.348).

- Set the printing effects (p.350) if necessary.

5 Select [OK].

- Before printing, be sure to set the paper size.
- Certain printers cannot imprint the file number.
- If [Bordered] is set, certain printers may imprint the date on the border.
- Depending on the printer, the date may appear faint if it is imprinted on a bright background or on the border.

- Under [Adjust levels], [Manual] cannot be selected.
- If you stopped the printing and want to resume printing the remaining images, select [Resume]. Note that printing will not resume if any of the following occur:
 - Before resuming the printing, you changed the print order or deleted print-ordered images.
 - When you set the index, you changed the paper setting before resuming the printing.
 - When you paused the printing, the card's remaining capacity was low.
- If a problem occurs during printing, see page 354.

Specifying Images for a Photobook

When you select images to use in photobooks (up to 998 images) and use EOS Utility (provided software) to transfer them to a computer, the selected images will be copied into a dedicated folder. This function is useful for ordering photobooks online.

Specifying One Image at a Time

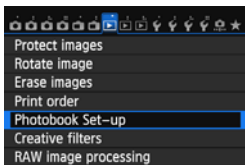

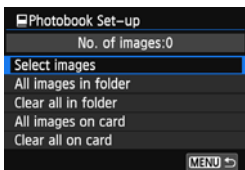

1 Select [Photobook Set-up].

- Under the [] tab, select [Photobook Set-up], then press <SET>.



2 Select [Select images].

- Select [Select images], then press <SET>.
- ▶ An image will be displayed.
- To display the three-image display, press the <· > button. To return to the single-image display, press the < > button.



3 Select the image to be specified.

- Turn the < > dial to select the image to be specified, then press <SET>.
- Repeat this step to select other images. The number of images that have been specified will be displayed on the upper left of the screen.
- To cancel the image specification, press <SET> again.
- To return to the menu, press the <MENU> button.

Specifying All Images in a Folder or on a Card

You can specify all the images in a folder or on a card at one time.

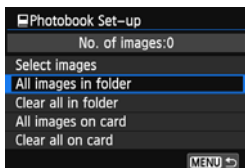

When [▶ 1: **Photobook Set-up**] is set to [**All images in folder**] or [**All images on card**], all the images in the folder or on the card will be specified.

To cancel the image specification, select [**Clear all in folder**] or [**Clear all on card**].

⚠ Do not specify images already specified for a photobook in another camera for another photobook with this camera. The photobook settings may be overwritten.

📄 RAW images and movies cannot be specified.

13

Customizing the Camera

You can customize various camera functions to suit your picture-taking preferences with Custom Functions. Also, the current camera settings can be saved under the Mode Dial <C> position.

The functions explained in this chapter work only in the Creative Zone modes.

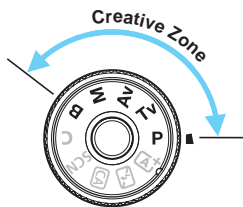

MENU Setting Custom Functions ☆

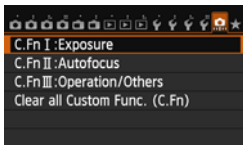

1 Select [**⏏**].

2 Select the group.

- Select C.Fn I, II, or III, then press <Ⓢ>.

Custom Function number

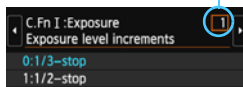

3 Select the Custom Function number.

- Press the <◀▶> key to select the Custom Function number, then press <Ⓢ>.

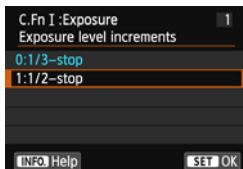

4 Change the setting as desired.

- Select the desired setting (number), then press <Ⓢ>.
- Repeat steps 2 to 4 if you want to set other Custom Functions.

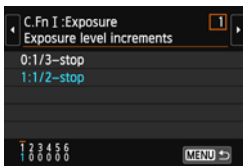

5 Exit the setting.

- Press the <MENU> button.
- ▶ The screen for step 2 will reappear.

Clearing All Custom Functions



In step 2, select [**Clear all Custom Func. (C.Fn)**] to clear all the Custom Function settings.

Even if you clear all the Custom Function settings, the [**⏏ C.Fn III-4: Custom Controls**] settings will be retained.

MENU Custom Functions ☆

C.Fn I: Exposure



1	Exposure level increments	p.365
2	ISO speed setting increments	p.365
3	Bracketing auto cancel	p.365
4	Bracketing sequence	p.366
5	Number of bracketed shots	p.366
6	Safety shift	p.367

 LV Shooting	 Movie Shooting
○	○
○	In M
○	(Still photo, with WB bracketing)
○	
○	

C.Fn II: Autofocus

1	Tracking sensitivity	p.368
2	Acceleration/deceleration tracking	p.369
3	AI Servo 1st image priority	p.369
4	AI Servo 2nd image priority	p.370
5	AF-assist beam firing	p.371
6	Lens drive when AF impossible	p.371
7	Select AF area selection mode	p.372
8	AF area selection method	p.372
9	Orientation linked AF point	p.373
10	Manual AF point selection pattern	p.373
11	AF point display during focus	p.374
12	VF display illumination	p.374
13	AF Microadjustment	p.375

With AFQuick*	
With AFQuick	
With AFQuick	
With AFQuick	
With AFQuick	
With AFQuick	
With AFQuick	

* If you use an EX-series Speedlite (sold separately) equipped with an LED light, the LED light will turn on for AF-assist even with AF , AF , and AF .



The shaded Custom Functions do not function during Live View (LV) shooting or movie shooting. (Settings are disabled.)

C.Fn III: Operation/Others

1	Dial direction during Tv/Av	p.375	<input type="radio"/>	<input type="radio"/>
2	Multi function lock	p.375	<input type="radio"/>	<input type="radio"/>
3	Warnings  in viewfinder	p.376		
4	Custom Controls	p.376	Depends on setting	

MENU Custom Function Settings ☆

C.Fn I: Exposure

C.Fn I -1 Exposure level increments

0: 1/3-stop

1: 1/2-stop

Sets 1/2-stop increments for the shutter speed, aperture, exposure compensation, AEB, flash exposure compensation, etc. This is effective when you prefer to control the exposure in less fine increments than 1/3-stop increments.



With setting 1, the exposure level will be displayed in the viewfinder and on the LCD panel as shown below.



C.Fn I -2 ISO speed setting increments

0: 1/3-stop

1: 1-stop

C.Fn I -3 Bracketing auto cancel

0: On

When you set the power switch to <OFF>, the AEB and white balance bracketing settings will be canceled. AEB will also be canceled when the flash is ready to fire or if you switch to movie shooting.

1: Off

The AEB and white balance bracketing settings will not be canceled even if you set the power switch to <OFF>. (If the flash is ready to fire or if you switch to movie shooting, AEB will be canceled temporarily, but the AEB range will be retained.)

C.Fn I -4 Bracketing sequence

The AEB shooting sequence and white balance bracketing sequence can be changed.

0: 0 → - → +

1: - → 0 → +

2: + → 0 → -

AEB	White Balance Bracketing	
	B/A Direction	M/G Direction
0 : Standard exposure	0 : Standard white balance	0 : Standard white balance
- : Decreased exposure	- : Blue bias	- : Magenta bias
+ : Increased exposure	+ : Amber bias	+ : Green bias

C.Fn I -5 Number of bracketed shots

The number of shots taken with AEB and white balance bracketing can be changed from the usual 3 shots to 2, 5, or 7 shots.

When [**Bracketing sequence: 0**] is set, the bracketed shots will be taken as shown in the table below.

0: 3 shots

1: 2 shots

2: 5 shots

3: 7 shots

(1-stop increments)

	1st Shot	2nd Shot	3rd Shot	4th Shot	5th Shot	6th Shot	7th Shot
0: 3 shots	Standard (0)	-1	+1				
1: 2 shots	Standard (0)	±1					
2: 5 shots	Standard (0)	-2	-1	+1	+2		
3: 7 shots	Standard (0)	-3	-2	-1	+1	+2	+3

 With setting 1, you can select the + or - amount when setting AEB.

C.Fn I -6 Safety shift

0: Disable

1: Shutter speed/Aperture

This takes effect in the shutter-priority AE (**Tv**) and aperture-priority AE (**Av**) modes. If the subject brightness changes and the standard exposure cannot be obtained within the autoexposure range, the camera will automatically change the manually-selected setting to obtain a standard exposure.

2: ISO speed

This works in the Program AE (**P**), shutter-priority AE (**Tv**), and aperture-priority AE (**Av**) modes. If the subject brightness changes and the standard exposure cannot be obtained within the autoexposure range, the camera will automatically change the manually set ISO speed to obtain a standard exposure.



- Under [**3: ISO speed settings**], even if [**ISO speed range**] or [**Min. shutter spd.**] is changed from the default setting, safety shift will override it if a standard exposure cannot be obtained.
- The minimum and maximum ISO speeds of the safety shift using the ISO speed will be determined by the [**Auto ISO range**] setting (p.124). However, if the manually set ISO speed exceeds the [**Auto ISO range**], the safety shift will take effect up to the manually set ISO speed.
- If [**Shutter speed/Aperture**] or [**ISO speed**] is set, safety shift will take effect if necessary even when flash is used.

C.Fn II: Autofocus

C.Fn II -1 Tracking sensitivity

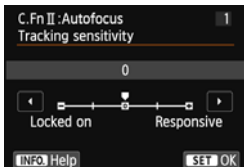

Sets the subject-tracking sensitivity during AI Servo AF when an obstacle enters the AF points or when the AF points stray from the subject.

0: Default setting suited for most subjects. Suited for normal, moving subjects.

Locked on: -2 / Locked on: -1

The camera will try to continue focusing the subject even if an obstacle enters the AF points or if the subject strays from the AF points. The -2 setting makes the camera track the target subject longer than with the -1 setting.

However, if the camera focuses the wrong subject, it may take slightly longer to switch and focus the target subject.

Responsive: +2 / Responsive:+1

Once an AF point tracks a subject, the camera can focus consecutive subjects at different distances. Also effective when you want to always focus on the closest subject. The +2 setting makes it quicker to focus the next consecutive subject than with +1.

However, the camera will be more prone to focus on the wrong subject.

 **[Tracking sensitivity]** is the feature named **[AI Servo tracking sensitivity]** in the EOS-1D Mark III/IV, EOS-1Ds Mark III, and EOS 7D.

C.Fn II -2 Acceleration/deceleration tracking

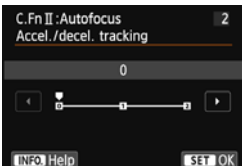

This sets the tracking sensitivity for moving subjects whose speed can suddenly change dramatically by starting or stopping suddenly, etc.

0: Suited for subjects that move at a fixed speed.

+2 / +1:

Effective for subjects having sudden movements, sudden acceleration/ deceleration, or sudden stops. Even if the moving subject's speed suddenly changes dramatically, the camera continues to focus the target subject. For example, for an approaching subject, the camera becomes less prone to focus behind it to avoid subject blur. For a subject stopping suddenly, the camera becomes less prone to focus in front of it. Setting +2 can track dramatic changes in the moving subject's speed better than with +1.

However, since the camera will be sensitive to even slight movements of the subject, the focusing may be unstable momentarily.

C.Fn II -3 AI Servo 1st image priority

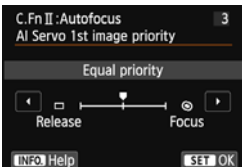

You can set the AF operation characteristics and shutter-release timing for the first shot during continuous shooting with AI Servo AF.

Equal priority:

Equal priority is given to focusing and shutter release.

□: Release priority

Pressing the shutter button takes the picture immediately even if focus has not been achieved. It is effective when you want give priority to the shutter chance rather than to focus.

⊙: Focus priority

Pressing the shutter button does not take the picture until focus has been achieved. Effective when you want to achieve focus before capturing the shot.

C.Fn II -4 AI Servo 2nd image priority

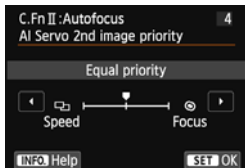

You can set the AF operation characteristics and shutter-release timing during continuous shooting after the first shot with AI Servo AF.

Equal priority:

Equal priority is given to focusing and continuous shooting speed. In low light or with low-contrast subjects, shooting speed may slow down.

☐: Shooting speed priority

Priority is given to the continuous shooting speed instead of achieving focus. The continuous shooting speed does not slow down. Convenient when you want to maintain the continuous shooting speed.

⊙: Focus priority

Priority is given to achieving focus instead of the continuous shooting speed. The picture is not taken until focus is achieved. Effective when you want to achieve focus before capturing the shot.

C.Fn II -5 AF-assist beam firing

Enables or disables the AF-assist beam emitted by the built-in flash or EOS-dedicated external Speedlite.

0: Enable

The AF-assist beam will be emitted when necessary.

1: Disable

The AF-assist beam is not emitted. This prevents the AF-assist beam from disturbing others.

2: Enable external flash only

The AF-assist beam will be emitted when necessary only if an external Speedlite is used. The camera's built-in flash will not fire the AF-assist beam.

3: IR AF assist beam only

When an external Speedlite is attached, only with infrared AF-assist beam will be emitted. This prevents the AF-assist light from firing as a burst of small flashes.

With an EX-series Speedlite equipped with an LED light, the LED light will not automatically turn on for AF-assist.



If the external Speedlite's **[AF-assist beam firing]** Custom Function is set to **[Disable]**, this function's setting will be overridden and the AF-assist beam will not be emitted by the Speedlite.

C.Fn II -6 Lens drive when AF impossible

If focus cannot be achieved with autofocus, you can have the camera keep searching for the correct focus or have it stop searching.

0: Continue focus search

1: Stop focus search

If autofocus starts and the focus is far off or if focus cannot be achieved, the lens drive stops. This prevents the lens from becoming grossly out of focus due to focus searching.



Super telephoto lenses can become grossly out of focus during continuous focus search, taking more time to achieve focus the next time. Therefore, setting **[1: Stop focus search]** is recommended for super telephoto lenses.

C.Fn II -7 Select AF area selection mode

You can limit the selectable AF area selection modes to suit your shooting preferences. Select the mode you want to use, then press $\langle \text{SET} \rangle$ to append a checkmark $\langle \checkmark \rangle$ and select [OK].

Manual selection: 1 pt AF

You can select one AF point.

Manual select.: Zone AF

The 19 AF points are divided into five zones for focusing.

Auto selection: 19 pt AF

All of the AF points are used for focusing.

 The $\langle \checkmark \rangle$ mark cannot be deleted from [Manual selection:1 pt AF].

C.Fn II -8 AF area selection method



You can set the method for changing the AF area selection mode.

0: → **AF area selection button**

After you press the $\langle \text{AF area selection button} \rangle$ or $\langle \text{AF area selection button} \rangle$ button, each time you press the $\langle \text{AF area selection button} \rangle$ button, the AF area selection mode changes.

1: → **Main Dial**

After you press the $\langle \text{AF area selection button} \rangle$ or $\langle \text{AF area selection button} \rangle$ button, turning the $\langle \text{Main Dial} \rangle$ dial changes the AF area selection mode.

 When [1:  → **Main Dial**] is set, use $\langle \text{Main Dial} \rangle$ to move the AF point horizontally.

C.Fn II -9 Orientation linked AF point

You can set the AF area selection mode and manually-selected AF point separately for vertical shooting and horizontal shooting.

0: Same for both vertical/horizontal

The same AF area selection mode and manually-selected AF point (or zone) are used for both vertical shooting and horizontal shooting.

1: Select separate AF points

The AF area selection mode and manually-selected AF point (or zone) can be set separately for each camera orientation (1. Horizontal, 2. Vertical with the camera grip at the top, 3. Vertical with the camera grip at the bottom). Convenient when, for instance, you want to keep using the right AF point during all camera orientations.

When you manually select the AF area selection mode and AF point (or zone) for each of the three camera orientations, they will be set for the respective orientation. Whenever you change the camera orientation, the camera will switch to the AF area selection mode and manually-selected AF point (or zone) set for that orientation.

C.Fn II -10 Manual AF point selection pattern

During manual AF point selection, the selection can either stop at the outer edge or it can move to the opposite AF point.

This works with single-point AF (manual selection) and 19-point automatic selection AF with AI Servo AF.

0: Stops at AF area edges

Convenient if you often use an AF point along the edge.

1: Continuous

Instead of stopping at the outer edge, the selected AF point continues to the opposite side.

C.Fn II -11 AF point display during focus

You can set whether or not to display the AF point(s) in the following cases: 1. When selecting the AF point(s), 2. When the camera is ready to shoot (before AF operation), 3. During AF operation, and 4. When focus is achieved.

0: Selected (constant)

The selected AF point(s) is always displayed.

1: All (constant)

All 19 AF points are always displayed.

2: Selected (pre-AF, focused)

The selected AF point(s) is displayed for 1, 2, and 4.

3: Selected (focused)

The selected AF point(s) is displayed for 1 and 4.

4: Disable display

For 2, 3, and 4, the selected AF point(s) will not be displayed.

 If [2: Selected (pre-AF, focused)] or [3: Selected (focused)] is set, the AF point will not be displayed even when focus is achieved with AI Servo AF.

C.Fn II -12 VF display illumination

The AF points and grid in the viewfinder can be illuminated in red when focus is achieved.

0: Auto

The AF points and grid are automatically illuminated in red under low light.

1: Enable

The AF points and grid are illuminated in red regardless of the ambient light level.

2: Disable

The AF points and grid are not illuminated in red.

-  • When AI Servo AF is set, there is no illumination in red even when focus is achieved.
- The setting here is not applied to the electronic level display (before shooting) (p.67) in the viewfinder.

 When you press the <[AF-ON]> or <[AF-ON]> button, the AF points and grid will be illuminated in red regardless of this setting.

C.Fn II -13 AF Microadjustment

Fine adjustment of the AF's point of focus is possible for viewfinder shooting or Live View shooting in the Quick mode. For details, see page 377.

C.Fn III: Operation/Others

C.Fn III -1 Dial direction during Tv/Av

0: Normal

1: Reverse direction

The dial's turning direction for setting the shutter speed and aperture can be reversed.

In the <M> shooting mode, the turning direction of the <☀> and <⊙> dials will be reversed. In the other shooting modes, the turning direction of only the <☀> dial will be reversed. The <⊙> dial's turning direction will be the same for the <M> mode and for setting the exposure compensation.

C.Fn III -2 Multi function lock

When the <LOCK> switch is set upward, it will prevent the <☀> and <⊙> dials and <⊛> from accidentally changing a setting.

Select the camera control you want to lock, then press <SET> to append a checkmark <✓> and select [OK].



: Main Dial



: Quick Control Dial







: Multi-controller



- If the <LOCK> switch is set and you try to use one of the locked camera controls, [L] will be displayed in the viewfinder and on the LCD panel. Also, on the shooting function settings display (p.49), [LOCK] will be displayed.
- By default, when the <LOCK> switch is set upward, the <⊙> dial will be locked.

C.Fn III -3 Warnings in viewfinder

When any of the following functions are set, the  icon can be displayed on the viewfinder's bottom right (p.23). The  icon will also appear on the shooting function settings display (p.49).

Select the function for which you want the warning icon to appear, press  to append a , then select [OK].

When monochrome is set:

If the Picture Style is set to [Monochrome] (p.127), the warning icon will appear.

When WB is corrected:

If white balance correction is set (p.138), the warning icon will appear.

When ISO expansion is used:

If the ISO speed is set manually to H (25600) (p.120), the warning icon will appear.

When spot metering is set:

If the metering mode is set to [Spot metering] (p.166), the warning icon will appear.

C.Fn III -4 Custom Controls

You can assign often-used functions to camera buttons or dials according to your preferences. For details, see page 383.

: Fine Adjustment of AF's Point of Focus ■

Fine adjustment of the AF's point of focus is possible for viewfinder shooting or Live View shooting in the Quick mode. This is called "AF Microadjustment". Before making the adjustment, read "Notes for AF Microadjustment" on page 382.



 **Normally, this adjustment is not required. Perform this adjustment only if necessary. Note that performing this adjustment may prevent correct focusing from being achieved.**

1: Adjust All by Same Amount

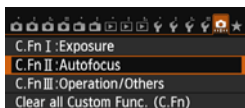
Set the adjustment manually by adjusting, shooting, and checking the result. Repeat this until the desired adjustment is made. During AF, regardless of the lens used, the point of focus will always be shifted by the adjustment amount.



1 Select [C.Fn II: Autofocus].

- Under the [] tab, select [C.Fn II: Autofocus], then press <  >.

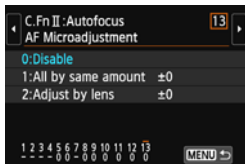

2 Select [13: AF Microadjustment].

- Select [13: AF Microadjustment], then press <  >.

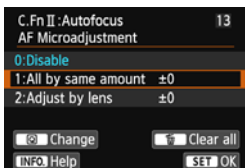

3 Select [1: All by same amount].

- Select [1: All by same amount].

4 Press the < > button.

- ▶ The [1: All by same amount] screen will appear.

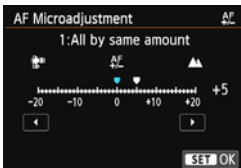

5 Make the adjustment.

- Press the <◀▶> key to make the adjustment. The adjustable range is ± 20 steps.
- Setting it toward “-: 📷” will shift the point of focus in front of the standard point of focus.
- Setting it toward “+: 📷” will shift the point of focus to the rear of the standard point of focus.
- After making the adjustment, press <SET>.
- Select [1: All by same amount], then press <SET>.
- Press the <MENU> button to exit.

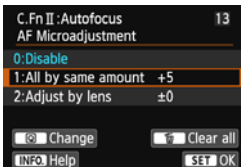

6 Check the result of the adjustment.

- Take a picture and play back the image (p.290) to check the adjustment result.
- When the resulting picture is focused in front of the targeted point, adjust toward the “+: 📷” side. When the resulting picture is focused behind the targeted point, adjust toward the “-: 📷” side.
- If necessary, do the adjustment again.

🔍 If [1: All by same amount] is selected, AF adjustment will not be possible for the wide-angle and telephoto ends of zoom lenses.

2: Adjust by Lens

You can make the adjustment for each lens and register the adjustment in the camera. You can register the adjustment for up to 40 lenses. When you autofocus with a lens whose adjustment has been registered, the point of focus will always be shifted by the adjustment amount. Set the adjustment manually by adjusting, shooting, and checking the result. If you use a zoom lens, make the adjustment for the wide-angle (W) and telephoto (T) ends.

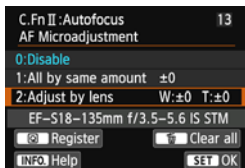

1 Select [2: Adjust by lens].

- Select [2: Adjust by lens].

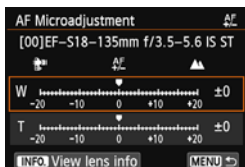

2 Press the <Q> button.

- ▶ The [2: Adjust by lens] screen will appear.

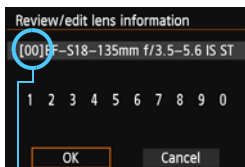

Registered number

3 Check and change the lens information.

Check the lens information.

- Press the <INFO.> button.
- ▶ The screen will show the lens name and a 10-digit serial number. When the serial number is displayed, select [OK] and go to step 4.
- If the lens' serial number cannot be confirmed, "0000000000" will be displayed. Enter the number as indicated below. See the next page about the asterisk "*" displayed in front of some lens serial numbers.

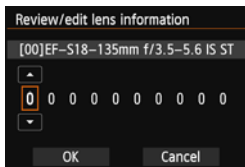

Enter the serial number.

- Press the <◀▶> key to select the digit to be entered, then press <SET> to display <⏏>.
- Press the <▲▼> key to enter the number, then press <SET>.
- After entering all the digits, select [OK] and press <SET>.

Lens Serial Number

- In step 3, if “ * ” appears in front of the 10-digit lens serial number, you cannot register several units of the same lens model. Even if you enter the serial number, “ * ” will remain displayed.
- The lens serial number on the lens may differ from the serial number displayed on the screen in step 3. This is not a malfunction.
- If the lens serial number includes letters, enter only the numbers in step 3.
- The location of the serial number differs depending on the lens.
- Some lenses may not have a serial number inscribed. To register a lens that has no serial number inscribed, enter any serial number in step 3.



- If [2: Adjust by lens] is selected and an Extender is used, the adjustment will be registered for the lens and Extender combination.
- If 40 lenses have already been registered, a message will appear. After you select a lens whose registration is to be erased (overwritten), you can register another lens.

Single focal length lens

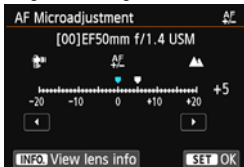

Zoom lens

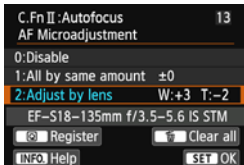
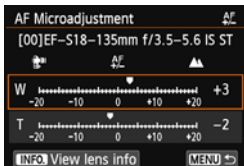

4 Make the adjustment.



- For a zoom lens, press the <▲▼> key and select the wide-angle (W) or telephoto (T) end. Press <SET> and the box will disappear, allowing you to make the adjustment.
- Press the <◀▶> key to adjust as desired, then press <SET>. The adjustable range is ±20 steps.
- Setting it toward “-: 📷 ” will shift the point of focus in front of the standard point of focus.
- Setting it toward “+: ▲ ” will shift the point of focus to the rear of the standard point of focus.
- For a zoom lens, repeat step 4 and adjust it for the wide-angle (W) and telephoto (T) ends.
- After completing the adjustment, press the <MENU> button to return to the screen in step 1.
- Select [2: Adjust by lens], then press <SET>.
- Press the <MENU> button to exit.

5 Check the result of the adjustment.





- Take a picture and play back the image (p.290) to check the adjustment result.
- When the resulting picture is focused in front of the targeted point, adjust toward the “+: ▲ ” side. When the resulting picture is focused behind the targeted point, adjust toward the “-: 📷 ” side.
- If necessary, do the adjustment again.

 When shooting with the intermediate range (focal length) of a zoom lens, the AF's point of focus is corrected automatically relative to the adjustments made for the wide-angle and telephoto ends. Even if only the wide-angle or telephoto end has been adjusted, a correction will be made automatically for the intermediate range.

Clearing All AF Microadjustments

When  **Clear all** appears at the bottom of the screen, pressing the  > button will clear all the adjustments made for **[1: All by same amount]** and **[2: Adjust by lens]**.

Notes for AF Microadjustment



-  ● The AF's point of focus will vary slightly depending on the subject conditions, brightness, zoom position, and other shooting conditions. Therefore, even if you perform AF Microadjustment, focus may still not be achieved at the suitable position.
 - If you clear all the Custom Function settings (p.362), the AF Microadjustment will be retained. However, the setting will become **[0: Disable]**.
- 
- It is best to make the adjustment at the actual location where you will shoot. This will make the adjustment more precise.
 - Using a tripod when making the adjustment is recommended.
 - For checking the adjustment result, shooting at the  image-recording quality is recommended.
 - The adjustment amount of one stop varies depending on the maximum aperture of the lens. Keep adjusting, shooting, and checking the focus repeatedly to adjust the AF's point of focus.
 - The AF Microadjustment will not be applied to  + Tracking, FlexiZone - Multi, and FlexiZone - Single during Live View shooting and movie shooting.

Custom Controls

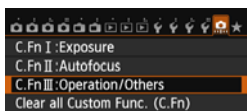
You can assign often-used functions to camera buttons or dials according to your preferences.



1 Select [C.Fn III: Operation/Others].

- Under the [] tab, select [C.Fn III: Operation/Others], then press < >.



2 Select [4: Custom Controls].

- Select [4: Custom Controls], then press < >.
- The Custom Controls screen will appear.



3 Select a camera button or dial.

- Select a camera button or dial, then press < >.
- The name of the camera control and the assignable functions will be displayed.







4 Assign a function.











- Select a function, then press < >.





5 Exit the setting.

- When you press < > to exit the setting, the screen in step 3 will reappear.
- Press the <MENU> button to exit.

 With the screen in step 3 displayed, you can press the < > button to cancel the Custom Control settings. Note that the [] C.Fn III-4: Custom Controls] settings will not be canceled even if you select [] Clear all Custom Func. (C.Fn)].

Assignable Functions to Camera Controls

Function		Page		AF-ON	*
AF	 AF Metering and AF start	386	<input type="radio"/>	<input type="radio"/>	<input type="radio"/>
	AF-OFF AF stop		<input type="radio"/>	<input type="radio"/>	
	ONESHOT, AI SERVO** ONE SHOT ↔ AI SERVO		<input type="radio"/>	<input type="radio"/>	
	 AF point direct selection		<input type="radio"/>	<input type="radio"/>	
Exposure	 Metering start	386	<input type="radio"/>	<input type="radio"/>	<input type="radio"/>
	AEL FEL AE lock/FE lock		<input type="radio"/>	<input type="radio"/>	
	* AE lock	387	<input type="radio"/>	<input type="radio"/>	<input type="radio"/>
	* AE lock (while button pressed)		<input type="radio"/>	<input type="radio"/>	
	* H AE lock (hold)		<input type="radio"/>	<input type="radio"/>	
	FEL FE lock		<input type="radio"/>	<input type="radio"/>	
	ISO ↓ Set ISO speed (hold button, turn )		<input type="radio"/>	<input type="radio"/>	
	Tv Shutter speed setting in M mode		<input type="radio"/>	<input type="radio"/>	
Av Aperture setting in M mode	<input type="radio"/>	<input type="radio"/>			
External flash	 Flash exposure compensation	388	<input type="radio"/>	<input type="radio"/>	<input type="radio"/>
Images	 Image quality	388	<input type="radio"/>	<input type="radio"/>	<input type="radio"/>
	 Picture Style		<input type="radio"/>	<input type="radio"/>	<input type="radio"/>
Operation	 Depth-of-field preview	388	<input type="radio"/>	<input type="radio"/>	<input type="radio"/>
	 IS start		<input type="radio"/>	<input type="radio"/>	<input type="radio"/>
	 VF electronic level		<input type="radio"/>	<input type="radio"/>	<input type="radio"/>
	MENU Menu display		<input type="radio"/>	<input type="radio"/>	<input type="radio"/>
	OFF No function (disabled)		<input type="radio"/>	<input type="radio"/>	<input type="radio"/>

	LENS*	SET			
	<input type="radio"/>				
<input type="radio"/>	<input type="radio"/>				
<input type="radio"/>	<input type="radio"/>				
					<input type="radio"/>
<input type="radio"/>	<input type="radio"/>				
<input type="radio"/>	<input type="radio"/>				
<input type="radio"/>	<input type="radio"/>				
<input type="radio"/>	<input type="radio"/>				
		<input type="radio"/>			
			<input type="radio"/>	<input type="radio"/>	
			<input type="radio"/>	<input type="radio"/>	
		<input type="radio"/>			
		<input type="radio"/>			
<input type="radio"/>					
<input type="radio"/>	<input type="radio"/>				
<input type="radio"/>					
		<input type="radio"/>			
<input type="radio"/>		<input type="radio"/>			<input type="radio"/>

 * The AF stop button (**LENS**) is provided only on super telephoto IS lenses.

: **AF: Metering and AF start**

When you press the button assigned to this function, metering and AF are executed.



: **AF-OFF: AF stop**

The AF will stop while you hold down the button assigned to this function. Convenient when you want to lock the focus during AI Servo AF.

: **ONE SHOT ↔ AI SERVO**

You can switch the AF operation. In One-Shot AF mode, when you hold down the button to which this function is assigned, the camera switches to AI Servo AF mode. In the AI Servo AF mode, the camera switches to One-Shot AF mode only while you hold down the button. Convenient when you need to keep switching between One-Shot AF and AI Servo AF for a subject that keeps moving and stopping.

: **AF point direct selection**

During metering, you can select an AF point directly with  without pressing the  or  button.

: **Metering start**

When you press the shutter button halfway, only exposure metering is performed.

: **AE lock/FE lock**

Normal shooting (No flash)

When you press the button assigned to this function, you can lock the exposure (AE lock) during the metering. Convenient when you want to focus and meter the shot at different areas or when you want to take multiple shots at the same exposure setting.

With flash

During flash photography, pressing the button assigned to this function will fire a preflash and record the required flash output (FE lock).

: AE lock

When you press the button assigned to this function, you can lock the exposure (AE lock) during the metering. Convenient when you want to focus and meter the shot at different areas or when you want to take multiple shots at the same exposure setting.

: AE lock (while button pressed)

The exposure will be locked (AE lock) while you press the shutter button.



_H : AE lock (hold)

When you press the button assigned to this function, you can lock the exposure (AE lock). The AE lock will be maintained until you press the button again. Convenient when you want to focus and meter the shot at different areas or when you want to take multiple shots at the same exposure setting.

FEL : FE lock



During flash photography, pressing the button assigned to this function will fire a preflash and record the required flash output (FE lock).

ISO : Set ISO speed (hold button, turn)



You can set the ISO speed by holding down < > and turning the < > dial.

If Auto ISO is set, manual ISO speed setting will take effect. Auto ISO cannot be set. If you use this function in the <**M**> mode, you can adjust the exposure with the ISO speed while maintaining the current shutter speed and aperture.

T_v : Shutter speed setting in M mode

In manual exposure <**M**>, you can set the shutter speed with the < > or < > dial.

A_v : Aperture setting in M mode

In manual exposure <**M**>, you can set the aperture with the < > or < > dial.

: Flash exposure compensation

Press < > to display the flash exposure compensation setting screen (p.190) on the LCD monitor.

: Image quality

Press < > to display the image-recording quality setting screen (p.116) on the LCD monitor.

: Picture Style

Press < > to display the Picture Style selection setting screen (p.126) on the LCD monitor.

: Depth-of-field preview

When you press the depth-of-field preview button, the aperture will stop down and you can check the depth of field (p.163).

: IS start

With the lens' IS switch set to <**ON**>, the lens' Image Stabilizer operates when you press the button assigned to this function (p.43).

: VF electronic level

When you press the button assigned to this function, the viewfinder will use the AF points to display an electronic level (before shooting) and grid (p.67).

MENU: Menu display

Pressing < > will display the menu on the LCD monitor.

OFF: No function (disabled)

Use this setting when you do not want to assign any function to the button.

MENU Registering My Menu ☆

Under the My Menu tab, you can register up to six menu options and Custom Functions whose settings you change frequently.

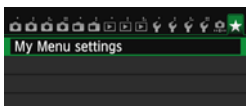

1 Select [My Menu settings].

- Under the [★] tab, select [My Menu settings], then press <SET>.

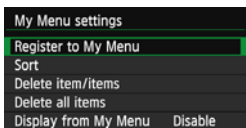

2 Select [Register to My Menu].

- Select [Register to My Menu], then press <SET>.

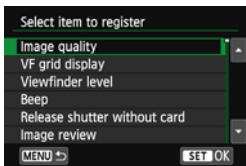

3 Register the desired items.

- Select the item, then press <SET>.
- Select [OK] and press <SET> to register the item.
- You can register up to six items.
- To return to the screen in step 2, press the <MENU> button.

My Menu Settings

● Sort

You can change the order of the registered items in My Menu. Select [Sort] and select the item whose order you want to change. Then press <SET>. With [◆] displayed, press the <▲▼> key to change the order, then press <SET>.

● Delete item/items and Delete all items

You can delete any of the registered items. [Delete item/items] deletes one item at a time, and [Delete all items] deletes all registered items.

● Display from My Menu

When [Enable] is set, the [★] tab will be displayed first when you display the menu screen.

C: Register Custom Shooting Modes ☆

You can register current camera settings, such as the shooting mode, menu functions, and Custom Function settings, as Custom shooting modes under the Mode Dial <C> position.

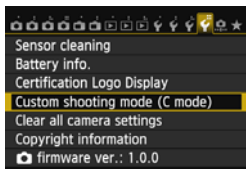

1 Select [Custom shooting mode (C mode)].

- Under the [**F4**] tab, select [**Custom shooting mode (C mode)**], then press <SET>.

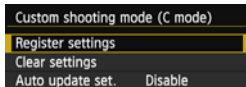

2 Select [Register settings].

- Select [**Register settings**], then press <SET>.

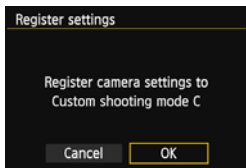

3 Register the Custom shooting mode.

- Select [**OK**], then press <SET>.
- ▶ The current camera settings (p.391) will be registered under the Mode Dial <C> position.

Automatic Updating

If you change any setting while you shoot in the <C> mode, the Custom shooting mode can be automatically updated to reflect the changed setting(s). To enable this automatic update, in step 2, set [**Auto update set.**] to [**Enable**]. The settings that can be automatically updated are listed on pages 391 and 392.

Canceling Registered Custom Shooting Modes















In step 2, if you select [**Clear settings**], the <C> will revert to the default setting effective before you registered the camera settings.

Settings Registered

● Shooting Function Settings

Shooting mode, Shutter speed, Aperture, ISO speed, Exposure compensation, Flash exposure compensation, AF operation, AF point, Drive mode, Metering mode.

● Menu functions

-  1 Image quality, VF grid display \equiv , Viewfinder level, Beep, Release shutter without card, Image review
-  2 Lens aberration correction (Peripheral illumination, Chromatic aberration), Flash control, E-TTL II metering, Flash sync. speed in Av mode, Red-eye reduction, Mirror lockup
-  3 Exposure compensation/AEB, ISO speed settings, Auto Lighting Optimizer, White balance, Custom White Balance, White balance Shift/Bracketing, Color space
-  4 Picture Style, Long exposure noise reduction, High ISO speed NR, Highlight tone priority, Multiple exposure (options), HDR Mode (options)
-  1 Live View shooting, AF method, Continuous AF, Grid display, Aspect ratio, Exposure simulation
-  2 Silent LV shooting, Metering timer
-  1 AF method, Movie Servo AF, Silent LV shooting, Metering timer
-  2 Grid display, Movie recording size, Digital zoom, Sound recording, Movie recording count, Movie play count, Video snapshot
-  2 Slide show (options), Image jump with 
-  3 Highlight alert, AF point display, Playback grid, Histogram display, Movie play count
-  1 File numbering, Auto rotate
-  2 Auto power off, LCD brightness, LCD off/on button
-  3 Touch control, **INFO** button display options
-  4 Auto cleaning

C.Fn I: Exposure



Exposure level increments, ISO speed setting increments, Bracketing auto cancel, Bracketing sequence, Number of bracketed shots, Safety shift

C.Fn II: Autofocus

Tracking sensitivity, Acceleration/deceleration tracking, AI Servo 1st image priority, AI Servo 2nd image priority, AF-assist beam firing, Lens drive when AF impossible, Select AF area selection mode, AF area selection method, Orientation linked AF point, Manual AF point selection pattern, AF point display during focus, VF display illumination, AF Microadjustment

C.Fn III: Operation/Others

Dial direction during Tv/Av, Multi function lock, Custom Controls

-  My Menu settings will not be registered.
- If the Mode Dial is set to <C>, you cannot select [4: Clear all camera settings] and [.: Clear all Custom Func. (C.Fn)].

-  Even when the Mode Dial is set to <C>, you can change the shooting function settings and menu settings.
- By pressing the <INFO.> button, you can check which shooting mode is registered under <C> (p.394, 395).

14

Reference

This chapter provides reference information for camera features, system accessories, etc.



Certification Logo

Select [**F4: Certification Logo Display**] and press <ⓈET> to display some of the logos of the camera's certifications. Other certification logos can be found in this Instruction Manual, on the camera body, and on the camera's package.

INFO. Button Functions

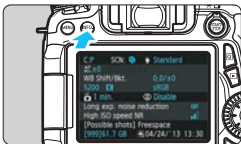

When you press the <INFO.> button while the camera is ready to shoot, you can display [Displays camera settings], [Electronic level] (p.65), and [Displays shooting functions] (p.395).

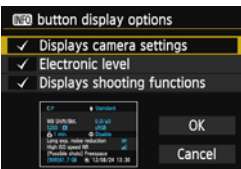

Under the [F3] tab, [INFO button display options] enables you to select the options displayed when the <INFO.> button is pressed.

- Select the desired display option and press <SET> to append a checkmark <✓>.
- After making the selection, select [OK], then press <SET>.

- Note that you cannot remove the <✓> for all three display options.
- The [Displays camera settings] sample screen is displayed in English for all languages.
- Even if you uncheck the [Electronic level] so it does not appear, it will still appear for Live View shooting and movie shooting when you press the <INFO.> button.

Camera Settings

Shooting mode registered to the Mode Dial's <C>

<SCN> mode (p.81)

(p.56)

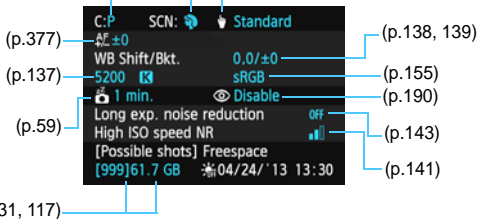

Shooting Function Settings

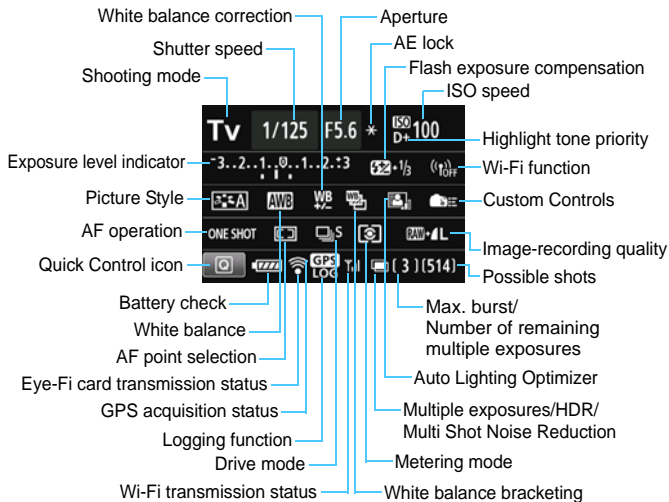

- Pressing the $\langle \text{Q} \rangle$ button enables Quick Control of the shooting settings (p.50).
- When you press the $\langle \text{AF} \rangle$, $\langle \text{DRIVE} \rangle$, $\langle \text{ISO} \rangle$, $\langle \text{M} \rangle$, $\langle \text{WB} \rangle$, or $\langle \text{AF-ON} \rangle$ button, the setting screen will appear and you can use $\langle \text{INFO} \rangle$, $\langle \text{M} \rangle$, $\langle \text{Q} \rangle$, and $\langle \text{INFO} \rangle$ to set the function.

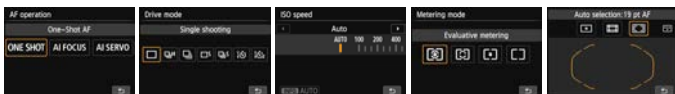

If you turn off the power while the “Shooting function settings display” screen is displayed, the same screen will be displayed when you turn on the power again. To cancel this, press the $\langle \text{INFO} \rangle$ button to exit from “Shooting function settings display” screen, then turn off the power switch.

MENU Checking the Battery Information

You can check the battery's condition on the LCD monitor. Each Battery Pack LP-E6 has a unique serial number, and you can register multiple battery packs to the camera. When you use this feature, you can check the registered battery pack's remaining capacity and operation history.

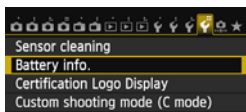

Battery position

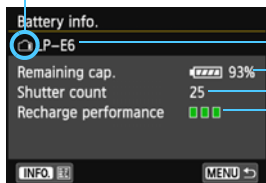

Select [Battery info.].

- Under the [F4] tab, select [Battery info.], then press <SET>.
- ▶ The battery info screen will appear.

Battery model or household power source being used.

The battery level icon (p.36) is displayed together with the remaining battery capacity shown in 1% increments.

The number of shots taken with the current battery. The number is reset when the battery is recharged.

Battery's recharge performance level is displayed in one of three levels.

■■■ (Green) : Battery's recharge performance is fine.

■■□ (Green) : Battery's recharge performance is slightly degraded.

■□□ (Red) : Purchasing a new battery is recommended.

 The use of a genuine Canon Battery Pack LP-E6 is recommended. If you use batteries that are not genuine Canon products, the camera's full performance may not be attained or malfunction may result.

- The shutter count is the number of still photos taken. (Movies are not counted.)
- The battery information will be displayed even when the LP-E6 battery pack is in Battery Grip BG-E14. If you use size-AA/LR6 batteries, only the battery level indicator will be displayed.
- If communication with the battery is not possible or irregular for some reason, [Use this battery?] will be displayed. If you select [OK], you can continue shooting. However, depending on the battery, the battery info screen may not be displayed or may not display battery info correctly.

Registering the Battery to the Camera

You can register up to six LP-E6 battery packs to the camera. To register multiple battery packs to the camera, do the procedure below for each battery pack.

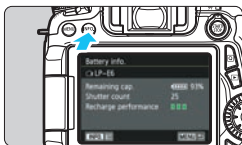

1 Press the **<INFO.>** button.

- With the battery info. screen displayed, press the **<INFO.>** button.
- ▶ The battery history screen will appear.
- ▶ If the battery has not been registered, it will be grayed out.

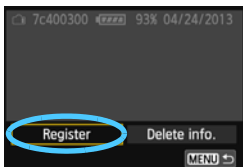

2 Select **[Register]**.

- Select **[Register]**, then press **<SET>**.
- ▶ The confirmation dialog will appear.

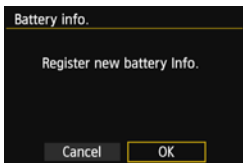

3 Select **[OK]**.

- Select **[OK]**, then press **<SET>**.
- ▶ The battery pack will be registered and the battery history screen will reappear.
- ▶ The grayed-out battery number will now be displayed in white.
- Press the **<MENU>** button. The battery info. screen will reappear.



- Battery registration is not possible if size-AA/LR6 batteries are in the Battery Grip BG-E14 or if you use the AC Adapter Kit ACK-E6.
- If six battery packs have already been registered, **[Register]** cannot be selected. To delete unnecessary battery information, see page 399.

Labeling the Serial Number on the Battery

It is convenient to label all registered Battery Pack LP-E6 with their serial numbers, using commercially available labels.

Serial number

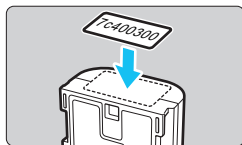
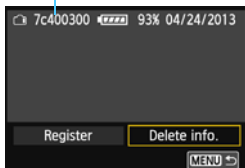

1 Write the serial number on a label.

- Write the serial number displayed on the battery history screen on a label approx. 25 mm x 15 mm / 1.0 in. x 0.6 in. in size.

2 Take out the battery and affix the label.

- Set the power switch to <OFF>.
- Open the battery compartment cover and remove the battery.
- Affix the label as shown (side with no electrical contacts) in the illustration.
- Repeat step 2 for all of your battery packs so you can easily see the serial number.

- Do not affix the label on any part other than as shown in the illustration in step 2. Otherwise, the misplaced label may make it difficult to insert the battery or impossible to turn on the camera.
- If you use Battery Grip BG-E14, the label may peel off as you repeatedly insert and remove the battery pack. If it peels off, affix a new label.

Checking the Remaining Capacity of a Registered Battery Pack

You can check the remaining capacity of any battery pack (even when not installed) and also when it was last used.

Serial number Date last used

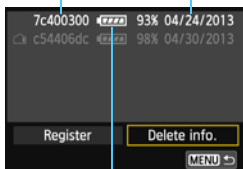

Remaining capacity

Look for the serial number.

- Refer to the battery's serial number label and look for the battery's serial number on the battery history screen.
- ▶ You can check the respective battery pack's remaining capacity and the date when it was last used.

Deleting the Registered Battery Pack Information

1 Select [Delete info.].

- Follow step 2 on page 397 to select [Delete info.], then press $\langle \text{SET} \rangle$.

2 Select the battery pack information to be deleted.

- Select the battery pack information to be deleted, then press $\langle \text{SET} \rangle$.
- ▶ $\langle \checkmark \rangle$ will appear.
- To delete information for another battery pack, repeat this procedure.

3 Press the $\langle \text{trash} \rangle$ button.

- ▶ The confirmation dialog will appear.

4 Select [OK].

- Select [OK], then press $\langle \text{SET} \rangle$.
- ▶ The battery pack information will be deleted and the screen in step 1 will reappear.

Using a Household Power Outlet

With AC Adapter Kit ACK-E6 (sold separately), you can connect the camera to a household power outlet and not worry about the remaining battery level.

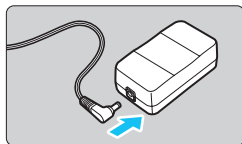

1 Connect the DC Coupler's plug.

- Connect the DC Coupler's plug to the AC Adapter's socket.

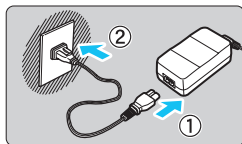

2 Connect the power cord.

- Connect the power cord as shown in the illustration.
- After using the camera, unplug the power plug from the power outlet.

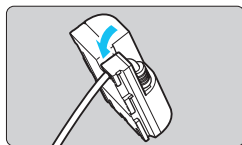

3 Place the cord in the groove.

- Insert the DC Coupler's cord carefully without damaging the cord.

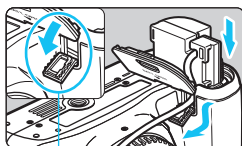

4 Insert the DC Coupler.

- Open the battery compartment cover and open the DC Coupler cord hole cover.
- Insert the DC Coupler securely until it locks and put the cord through the hole.
- Close the cover.

DC Coupler cord hole

 Do not connect or disconnect the power cord or DC Coupler while the camera's power switch is set to <ON>.

Using Eye-Fi Cards

With a commercially-available Eye-Fi card already set up, you can automatically transfer captured images to a computer or upload them to an online service via a wireless LAN.

The image transfer is a function of the Eye-Fi card. For instructions on how to set up and use the Eye-Fi card or to troubleshoot any image transfer problems, refer to the Eye-Fi card's instruction manual or contact the card manufacturer.

 **The camera is not guaranteed to support Eye-Fi card functions (including wireless transfer). In case of an issue with an Eye-Fi card, please check with the card manufacturer. Also note that approval is required to use Eye-Fi cards in many countries or regions. Without approval, use of the card is not permitted. If it is unclear whether the card has been approved for use in your area, please check with the card manufacturer.**

1 Insert an Eye-Fi card (p.31).

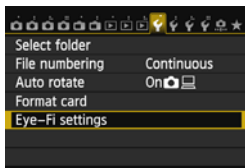

2 Select [Eye-Fi settings].

- Under the [**1**] tab, select [**Eye-Fi settings**], then press <SET>.
- This menu is displayed only when an Eye-Fi card is inserted into the camera.

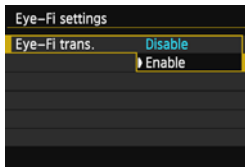

3 Enable Eye-Fi transmission.

- Select [**Eye-Fi trans.**], then press <SET>.
- Select [**Enable**], then press <SET>.
- If you set [**Disable**], automatic transmission will not occur even with the Eye-Fi card inserted (transmission status icon ).

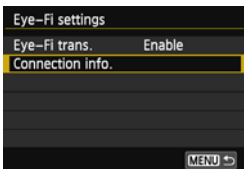

4 Display the connection information.

- Select [**Connection info.**], then press <SET>.



5 Check the [**Access point SSID:**].





- Check that an access point is displayed for [**Access point SSID:**].
- You can also check the Eye-Fi card's MAC address and firmware version.
- Press the <MENU> button to exit the menu.





Transmission status icon

6 Take the picture.

- ▶ The picture is transferred and the <Wi-Fi> icon switches from gray (not connected) to one of the icons below.
- For transferred images,  is displayed in the shooting information display (p.292).

-  (Gray) **Not connected** : No connection with access point.
-  (Blinking) **Connecting...**: Connecting to access point.
-  (Displayed) **Connected** : Connection to access point established.
-  (↑) **Transferring...** : Image transfer to access point in progress.

Cautions for Using Eye-Fi Cards

- If [**43: Wi-Fi**] is set to [**Enable**], image transfer with an Eye-Fi card is not possible.
- If “” is displayed, an error occurred while retrieving the card information. Turn the camera's power switch off and on again.
- Even if [**Eye-Fi trans.**] is set to [**Disable**], it may still transmit a signal. In hospitals, airports, and other places where wireless transmissions are prohibited, remove the Eye-Fi card from the camera.
- If the image transfer does not function, check the Eye-Fi card and computer settings. For details, refer to the card's instruction manual.
- Depending on the wireless LAN's connection conditions, the image transfer may take longer or it may be interrupted.
- Because of the transmission function, the Eye-Fi card may become hot.
- The battery power will be consumed faster.
- During the image transfer, auto power off will not take effect.
- If you insert a wireless LAN card other than an Eye-Fi card, [**Eye-Fi settings**] will not appear. Also, the transmission status icon < > will not appear.

Function Availability Table According to Shooting Mode

Still Photo Shooting

● : Set automatically ○ : User selectable □ : Not selectable/Disabled

Function		Basic Zone									Creative Zone					
		A+	Tv	CA	SCN						P	Tv	Av	M	B	
					👤	🏞️	🌿	🎨	📷	📖						🌟
All image quality settings selectable		○	○	○	○	○	○	○	○	○ ⁺¹	○ ⁺¹	○	○	○	○	○
ISO speed	Automatically set/Auto ISO	●	●	●	●	●	●	●	●	●	●	○	○	○	○	○
	Manual	□	□	□	□	□	□	□	□	□	□	○	○	○	○	○
Picture Style	Automatically set/Auto	●	●	●	●	●	●	●	●	●	●	○	○	○	○	○
	Manual selection	□	□	□	□	□	□	□	□	□	□	○	○	○	○	○
Ambience-based shots		□	□	○	○	○	○	○	○	○	□	□	□	□	□	□
Light/scene-based shots		□	□	□	○	○	○	○	□	□	□	□	□	□	□	□
Creative filters^{*2}		○	○	○	○	○	○	○	□	□	□	○	○	○	○	○
White balance	Auto	●	●	●	●	●	●	●	●	●	○	○	○	○	○	○
	Preset	□	□	□	□	□	□	□	□	□	□	○	○	○	○	○
	Custom	□	□	□	□	□	□	□	□	□	□	○	○	○	○	○
	Color temperature setting	□	□	□	□	□	□	□	□	□	□	○	○	○	○	○
	Correction/Bracketing	□	□	□	□	□	□	□	□	□	□	○	○	○	○	○
Auto Lighting Optimizer		●	●	●	●	●	●	●	●	●	○	○	○	○	○	○
Lens aberration correction	Peripheral illumination correction	○	○	○	○	○	○	○	○	○	○	○	○	○	○	○
	Chromatic aberration correction	○	○	○	○	○	○	○	○	○	○	○	○	○	○	○
Long exposure noise reduction		□	□	□	□	□	□	□	□	□	□	○	○	○	○	○
High ISO speed noise reduction		●	●	●	●	●	●	●	●	●	○	○	○	○	○	○
Highlight tone priority		□	□	□	□	□	□	□	□	□	□	○	○	○	○	○
Multiple exposures		□	□	□	□	□	□	□	□	□	□	○	○	○	○	○
HDR shooting		□	□	□	□	□	□	□	□	□	□	○	○	○	○	□
Color space	sRGB	●	●	●	●	●	●	●	●	●	○	○	○	○	○	○
	Adobe RGB	□	□	□	□	□	□	□	□	□	□	○	○	○	○	○
AF	One-Shot AF	□	□	□	●	●	●	□	●	●	●	○	○	○	○	○
	AI Servo AF	□	□	□	□	□	□	●	□	□	□	○	○	○	○	○
	AI Focus AF	●	●	●	□	□	□	□	□	□	□	○	○	○	○	○
	AF area selection mode	□	□	□	□	□	□	□	□	□	□	○	○	○	○	○
	AF point selection	●	●	●	●	●	●	●	●	●	●	○	○	○	○	○
	Manual focusing (MF)	○	○	○	○	○	○	○	○	○	○	○	○	○	○	○

*1: RAW+JPEG and RAW cannot be selected.

*2: Settable only for Live View shooting.

Function		Basic Zone										Creative Zone				
		A+	S	CA	SCN							P	Tv	Av	M	B
					1	2	3	4	5	6	7					
AF	AF-assist beam	●*3		●*3	●*3	*4	●*3	*4	●	●*3	●	○	○	○	○	○
	AF Microadjustment											○	○	○	○	○
	Continuous AF*2	○	○	○	○	○	○	○	○	○	○	○	○	○	○	○
Metering mode	Evaluative metering	●	●	●	●	●	●	●	●	●	●	○	○	○	○	○
	Metering mode selection											○	○	○	○	○
Exposure	Program shift											○				
	AE lock											○	○	○	*5	
	Exposure compensation											○	○	○		
	AEB											○	○	○	○	
	Depth-of-field preview											○	○	○	○	○
Drive	Single shooting	○	○	○	○	○	○	○	○	○	○	○	○	○	○	○
	High-speed continuous shooting	○	○	○	○	○	○	○	○	○	○	○	○	○	○	○
	Low-speed continuous shooting	○	○	○	○	○	○	○	○	○	○	○	○	○	○	○
	Silent single shooting	○	○	○	○	○	○	○	○	○	○	○	○	○	○	○
	Silent continuous shooting	○	○	○	○	○	○	○	○	○	○	○	○	○	○	○
	10-sec. self-timer/Remote control	○	○	○	○	○	○	○	○	○	○	○	○	○	○	○
	2-sec. self-timer/Remote control	○	○	○	○	○	○	○	○	○	○	○	○	○	○	○
Built-in flash	Automatic firing	○		○	○		○		●							
	Manual firing	○		○	○		○			○		○	○	○	○	○
	Flash off	○	●	○	○	●	○	●		○	●	○	○	○	○	○
	Red-eye reduction	○		○	○		○		○		○	○	○	○	○	○
	FE lock											○	○	○	○	○
	Flash exposure compensation											○	○	○	○	○
	Wireless control											○	○	○	○	○
External flash	Function settings											○	○	○	○	○
	Custom Function settings											○	○	○	○	○
Live View shooting		○	○	○	○	○	○	○	○	○	○	○	○	○	○	○
Quick Control		○	○	○	○	○	○	○	○	○	○	○	○	○	○	○

*3: If the built-in flash is set to $\langle \text{A}+ \rangle$, the AF-assist beam will not be fired.

*4: If the AF method is Quick mode during Live View shooting, the external Speedlite will emit the AF-assist beam when necessary.

*5: With Auto ISO, you can set a fixed ISO speed.

Movie Shooting

● : Set automatically ○ : User selectable □ : Not selectable/Disabled

Function		Movie									Still Photos		
		A ⁺	S ⁺	CA	SCN	P	Tv	Av	B	M	📷*1		
		📷*1				📷*1				📷*1	📷*1	📷*1	
All image quality settings selectable (movie)		○	○	○	○	○	○	○	○	○			
All image quality settings selectable (still photos)											○	○	○
Digital zoom		○	○	○	○	○	○	○	○	○			
Video snapshots		○	○	○	○	○	○	○	○	○			
ISO speed	Automatically set/Auto ISO	●	●	●	●	●	●	●	●	○	●	●	○
	Manual									○			○
Picture Style	Automatically set/Auto	●	●	●	●	○	○	○	○	○	●	○	○
	Manual selection					○	○	○	○	○		○	○
White balance	Auto	●	●	●	●	○	○	○	○	○	●	○	○
	Preset					○	○	○	○	○		○	○
	Custom					○	○	○	○	○		○	○
	Color temperature setting					○	○	○	○	○		○	○
	Correction					○	○	○	○	○		○	○
	Bracketing											○	○
Auto Lighting Optimizer		●	●	●	●	○	○	○	○	○	●	○	○
Lens aberration correction	Peripheral illumination correction	○	○	○	○	○	○	○	○	○	○	○	○
	Chromatic aberration correction	○	○	○	○	○	○	○	○	○	○	○	○
Long exposure noise reduction												○	
High ISO speed noise reduction*2		●	●	●	●	○	○	○	○	○	●	○	○
Highlight tone priority						○	○	○	○	○		○	○
Multiple exposures													
HDR shooting													
Color space	sRGB	●	●	●	●	●	●	●	●	●	●	○	○
	Adobe RGB											○	○

*1 : The 📷 icon indicates still photo shooting during movie shooting.

*2 : Multi Shot Noise Reduction (NR) cannot be set.

Function		Movie									Still Photos			
		A ⁺	S	CA	SCN	P	Tv	Av	B	M	*1			
		A ⁺			M			M	A ⁺	M	M			
AF	ⓧ+Tracking	○	○	○	○	○	○	○	○	○	○	○	○	○
	FlexiZone - Multi	○	○	○	○	○	○	○	○	○	○	○	○	○
	FlexiZone - Single	○	○	○	○	○	○	○	○	○	○	○	○	○
	Manual focusing (MF)	○	○	○	○	○	○	○	○	○	○	○	○	○
	Movie Servo AF	○	○	○	○	○	○	○	○	○	○	○	○	○
Metering mode		●	●	●	●	●	●	●	●	●	●	●	●	●
Exposure	Program shift													
	AE lock					○	○	○	○	*3		○		*3
	Exposure compensation					○	○	○	○			○		
	AEB													
	Depth-of-field preview													
Drive	Single shooting											○	○	○
	High-speed continuous shooting											○	○	○
	Low-speed continuous shooting											○	○	○
	Silent single shooting											○	○	○
	Silent continuous shooting											○	○	○
	10-sec. self-timer/ Remote control *4											○	○	○
	2-sec. self-timer/ Remote control *4											○	○	○
Built-in/ External flash	Flash on													
Sound recording		○	○	○	○	○	○	○	○	○				
Time code		○	○	○	○	○	○	○	○	○				
Quick Control		○	○	○	○	○	○	○	○	○	○	○	○	○

*3 : With Auto ISO, you can set a fixed ISO speed.

*4 : Works only before you start shooting a movie.

Menu Settings

Viewfinder Shooting and Live View Shooting

📷: Shooting 1 (Red)

Page

Image quality	RAW* / M RAW* / S RAW*	116
	L / L / M / M / S1 / S1/S2/S3	
VF grid display	Disable / Enable	64
Viewfinder level	Hide / Show	66
Beep	Enable / Touch to 🔊 / Disable	59
Release shutter without card	Enable / Disable	32
Image review	Off / 2 sec. / 4 sec. / 8 sec. / Hold	60

* Not selectable in <P> or <S> mode.

* For movie shooting, [VF grid display] and [Viewfinder level] do not appear.

📷: Shooting 2 (Red)































Lens aberration correction	Peripheral illumination correction: Enable / Disable Chromatic aberration correction: Enable / Disable	146
Flash control	Flash firing / E-TTL II metering / Flash sync. speed in Av mode / Built-in flash settings / External flash function settings / External flash C.Fn setting / Clear settings	195
Red-eye reduction	Disable / Enable	190
Mirror lockup	Disable / Enable	182

* For movie shooting, [Flash control] and [Red-eye reduc.] do not appear.

📄 Shaded menu options are not displayed in Basic Zone modes.









 **Shooting 3 (Red)**

Page

Exposure compensation/AEB	1/3-stop increments, ± 5 stops (AEB ± 3 stops)	167 168
ISO speed settings	ISO speed / ISO speed range / Auto ISO range / Minimum shutter speed	120
Auto Lighting Optimizer	Disable / Low / Standard / High	140
	OFF with M or Bulb	
White balance	 /  /  /  /  /  /  /  /  /  /  /  /  /  /  /  /  /  /  /  /  /  /  /  /  /  /  /  /  /  / (Approx. 2500 - 10000)	134
Custom white balance	Manual setting of white balance	135
White balance shift/bracketing	White balance correction: B/A/M/G bias, 9 levels each	138
	White balance bracketing: B/A and M/G bias, single-level increments, ± 3 levels	139
Color space	sRGB / Adobe RGB	155

* During movie shooting, [Expo.comp./AEB] will be [Exposure comp.].

 **Shooting 4 (Red)**

Picture Style	 Auto /  Standard /  Portrait /  Landscape /  Neutral /  Faithful /  Monochrome /  User Def. 1-3	126
Long exposure noise reduction	Disable / Auto / Enable	143
High ISO speed noise reduction	Disable / Low / Standard / High / Multi Shot Noise Reduction	141
Highlight tone priority	Disable / Enable	145
Dust Delete Data	Obtain data to be used by provided software to delete dust spots	341
Multiple exposure	Multiple exposure / Multi-expos control / No. of exposures / Continue Multiple exposure	175
HDR Mode	Adjust dynamic range / Continuous HDR / Auto Image Align	172

* For movie shooting, [Multiple exposure] and [HDR Mode] do not appear.

📷 1: Live View shooting 1 (Red)

Page

Live View shooting	Enable / Disable	228
AF method	☺+Tracking / FlexiZone - Multi / FlexiZone - Single / Quick mode	233
Continuous AF	Enable / Disable	228
Touch Shutter	Enable / Disable	229
Grid display	Off / 3x3 田 / 6x4 田田 / 3x3+diag 田田	229
Aspect ratio	3:2 / 4:3 / 16:9 / 1:1	229
Exposure simulation	Enable / During 田田 / Disable	230

📷 2: Live View shooting 2 (Red)

Silent LV shooting	Mode 1 / Mode 2 / Disable	231
Metering timer	4 sec. / 16 sec. / 30 sec. / 1 min. / 10 min. / 30 min.	232

▶: Playback 1 (Blue)



Protect images	Erase-protect images	320
Rotate image	Rotate images	301
Erase images	Erase images	322
Print order	Specify images to be printed (DPOF)	355
Photobook set-up	Specify images for a photobook	359
Creative filters	Grainy B/W / Soft focus / Fish-eye effect / Art bold effect / Water painting effect / Toy camera effect / Miniature effect	335
RAW image processing	Process RAW images	328

▶: Playback 2 (Blue)

Page

Resize	Downsize the image's pixel count	333
Rating	[OFF] / [•] / [••] / [•••] / [••••] / [•••••]	302
Slide show	Playback description / Display time / Repeat / Transition effect / Background music	312
Image jump w/ 	1 image / 10 images / 100 images / Date / Folder / Movies / Stills / Rating	297

▶: Playback 3 (Blue)

Highlight alert	Disable / Enable	294
AF point display	Disable / Enable	294
Playback grid	Off / 3x3  / 6x4  / 3x3+diag 	291
Histogram display	Brightness / RGB	295
Movie play count*	Rec time / Time code	271
Control over HDMI	Disable / Enable	317

* This setting is linked to [Movie play count] under [▶▶ 2: Time code].

🔑: Set-up 1 (Yellow)

Page

Select folder	Create and select a folder	149
File number	Continuous / Auto reset / Manual reset	151
Auto rotate	On / On / Off	325
Format card	Initialize and erase data on the card	57
Eye-Fi settings	Displayed when a commercially-available Eye-Fi card is inserted	401

🔑: Set-up 2 (Yellow)

Auto power off	1 min. / 2 min. / 4 min. / 8 min. / 15 min. / 30 min. / Disable	59
LCD brightness	Seven brightness levels	324
LCD off/on button*	Remains on / Shutter button	60
Date/Time/Zone	Date (year, month, day) / Time (hour, min., sec.) / Daylight saving time / Time zone	37
Language 	Select the interface language	39
GPS device settings	Settings available when the GPS Receiver GP-E2 (sold separately) is attached	-

* During movie shooting, [LCD off/on btn] does not appear.

When using GPS, be sure to check the countries and areas of use, and use the device in accordance with the laws and regulations of the country or region.

Set-up 3 (Yellow)

Page

Video system	NTSC / PAL	265 319
Feature guide	Enable / Disable	69
Touch control	Standard / Sensitive / Disable	56
 Button display options	Displays camera settings / Electronic level / Displays shooting functions	394
Wi-Fi	Disable / Enable	-*
Wi-Fi function	Transfer images between cameras / Connect to smartphone / Remote control (EOS Utility) / Print from Wi-Fi printer / Upload to Web service / View images on DLNA devices	

* The EOS 70D (N) does not have the Wi-Fi function (Not displayed).

* For details, refer to the Wi-Fi Function Instruction Manual on the CD-ROM.



- When using Wi-Fi function, be sure to check the countries and areas of use, and use it in accordance with the laws and regulations of the country or region.
- Wi-Fi cannot be set if the camera is connected to a printer, computer, GPS receiver or other device with an interface cable.

🔧 : Set-up 4 (Yellow)

Page

Sensor cleaning	Auto cleaning: Enable / Disable	340
	Clean now	
	Clean manually	343
Battery info.	Power / Remaining capacity / Shutter count / Recharge performance / Battery registration / Battery history	396
Certification Logo Display	Displays some of the logos of the camera's certifications	393
Custom shooting mode (C mode)	Register current camera settings to the Mode Dial's <C> position	390
Clear all camera settings	Resets the camera to the default settings	61
Copyright information	Display copyright information / Enter author's name / Enter copyright details / Delete copyright information	153
📷 firmware ver.:*	For updating the firmware	-

* During firmware updates, the touch screen will be disabled to prevent accidental operations.

🔧 : Custom Functions (Orange)

C.Fn I: Exposure	Customize camera functions as desired	365
C.Fn II: Autofocus		368
C.Fn III: Operation/ Others		375
Clear all Custom Functions (C.Fn)	Clear all Custom Function settings	362

★ : My Menu (Green)

My Menu settings	Register frequently-used menu options and Custom Functions	389
-------------------------	--	-----



Movie Shooting

☰ 1: Movie 1 (Red)

Page

AF method	☑ +Tracking / FlexiZone - Multi / FlexiZone - Single	273
Movie Servo AF	Enable / Disable	273
Silent LV shooting	Mode 1 / Mode 2 / Disable	275
Metering timer	4 sec. / 16 sec. / 30 sec. / 1 min. / 10 min. / 30 min.	275

☰ 2: Movie 2 (Red)

Grid display	Off / 3x3  / 6x4  / 3x3+diag 	276
Movie recording size	1920x1080 (F30 / F25 / F24) (ALL / IPB) 1280x720 (F60 / F50) (ALL / IPB) 640x480 (F30 / F25) (IPB)	265
Digital zoom	Disable / Approx. 3-10x zoom	267
Sound recording*¹	Sound recording: Auto / Manual / Disable	268
	Recording level	
	Wind filter: Disable / Enable	
	Attenuator: Disable / Enable	
Time code	Count up / Start time setting / Movie recording count / Movie play count* ² / Drop frame	270
Video snapshot	Video snapshot: Enable / Disable	277
	Album settings: Create a new album / Add to existing album	

*1: In Basic Zone modes, the settings available for [Sound recording] will be [On/Off].

*2: The setting is linked to [▶ 3: Movie play count].

System Map

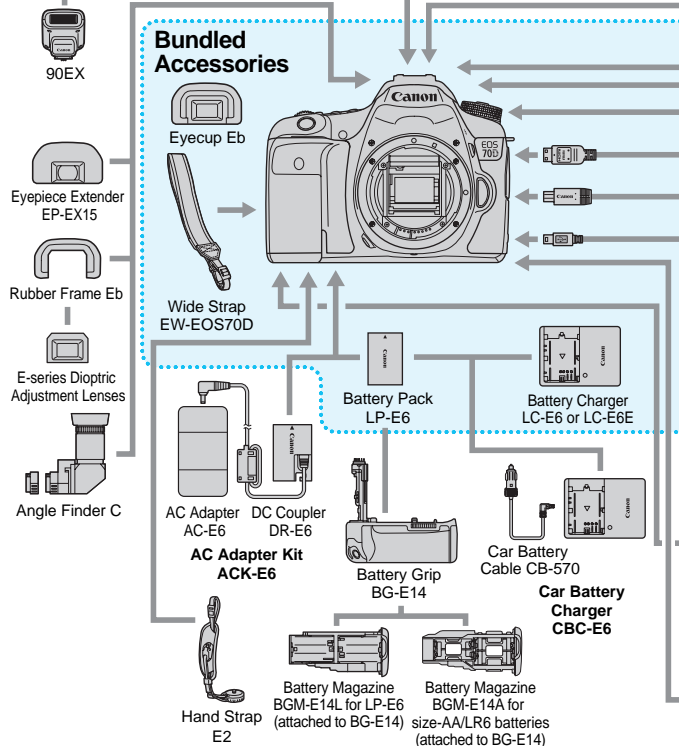
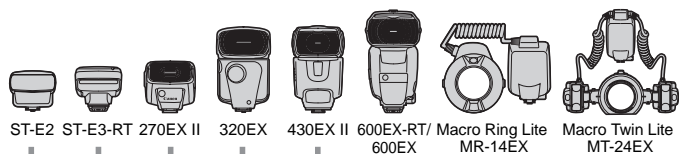

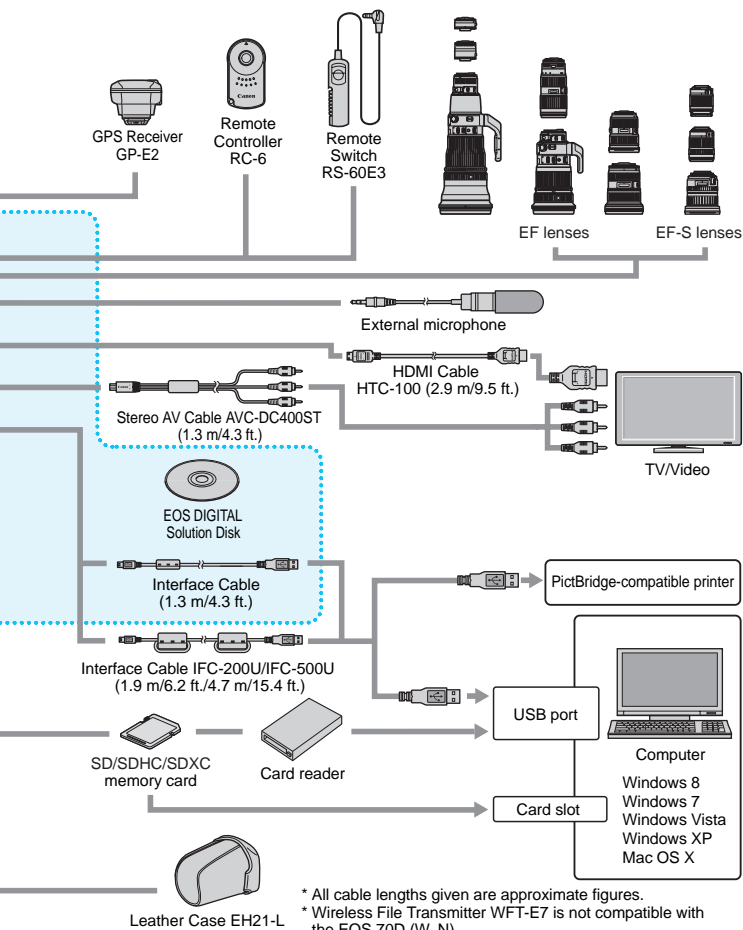

Troubleshooting Guide

If a problem occurs with the camera, first refer to this Troubleshooting Guide. If this Troubleshooting Guide does not resolve the problem, contact your dealer or nearest Canon Service Center.

Power-Related Problems

The battery pack does not recharge.

- If the battery's remaining capacity is 94% or higher, the battery will not be recharged (p.396).
- Do not recharge any battery pack other than genuine Canon Battery Pack LP-E6.

The charger's lamp blinks at high speed.

- If (1) the battery charger or battery pack has a problem or (2) communication with the battery pack failed (with a non-Canon battery pack), the protection circuit will stop the charging and the lamp will blink in orange at high speed. In the case of (1), unplug the charger's power plug from the power outlet. Detach and reattach the battery pack to the charger. Wait a few minutes, then reconnect the power plug to the power outlet. If the problem persists, contact your dealer or nearest Canon Service Center.

The charger's lamp does not blink.

- If the internal temperature of the battery pack attached to the charger is high, the charger will not charge the battery for safety reasons (lamp off). During the charging, if the battery's temperature becomes high for any reason, the charging will stop automatically (lamp blinks). When the battery temperature goes down, the charging will resume automatically.

The camera does not operate even when the power switch is set to <ON>.

- Make sure the battery is installed properly in the camera (p.30).
- Make sure the battery compartment cover is closed (p.30).
- Make sure the card slot cover is closed (p.31).
- Recharge the battery (p.28).

The access lamp still blinks even when the power switch is set to <OFF>.

- If the power is turned off while an image is being recorded to the card, the access lamp will remain on or continue to blink for a few seconds. When the image recording is completed, the power will turn off automatically.

The battery becomes exhausted quickly.

- Use a fully-charged battery pack (p.28).
- The battery performance may have degraded. See [**4: Battery info.**] to check the battery's recharge performance level (p.396). If the battery performance is poor, replace the battery pack with a new one.
- The number of possible shots will decrease with any of the following operations:
 - Pressing the shutter button halfway for a prolonged period.
 - Often activating only the AF without taking a picture.
 - Using the lens' Image Stabilizer.
 - Using the LCD monitor often.
 - Continuing Live View shooting or movie shooting for a prolonged period.
 - The Eye-Fi card's transmission is enabled.

The camera turns off by itself.

- Auto power off is in effect. If you do not want auto power off to take effect, set [**2: Auto power off**] to [**Disable**] (p.59).
- Even if [**2: Auto power off**] is set to [**Disable**], the LCD monitor will still turn off after the camera is left idle for 30 min. (The camera's power does not turn off.)

Shooting-Related Problems

The lens cannot be attached.

- The camera cannot be used with EF-M lenses (p.40).

The viewfinder is dark.

- Install a recharged battery pack in the camera (p.28).

No images can be shot or recorded.

- Make sure the card is properly inserted (p.31).
- Slide the card's write-protect switch to the write/erase position (p.31).
- If the card is full, replace the card or delete unnecessary images to make space (p.31, 322).
- If you try to focus in the One-Shot AF mode while the focus confirmation light <●> in the viewfinder blinks, a picture cannot be taken. Press the shutter button halfway again to refocus automatically, or focus manually (p.45, 110).

The card cannot be used.

- If a card error message is displayed, see page 33 or 432.

The image is out of focus.

- Set the lens focus mode switch to <AF> (p.40).
- To prevent camera shake, press the shutter button gently (p.44, 45).
- If the lens has an Image Stabilizer, set the IS switch to <ON>.
- In low light, the shutter speed may become slow. Use a faster shutter speed (p.160), set a higher ISO speed (p.120), use flash (p.188, 193), or use a tripod.

I cannot lock the focus and recompose the shot.

- Set the AF operation to One-Shot AF. Focus lock is not possible in the AI Servo AF mode, or when servo takes effect in AI Focus AF mode (p.75).

AF speed changes depending on lenses used.

- If the AF method is set to [**L**+Tracking], [FlexiZone - Multi], or [FlexiZone - Single] for Live View shooting or movie shooting, the AF control method (phase-difference detection with the image sensor or contrast detection) will switch automatically depending on the lens used and functions selected, such as movie digital zoom or magnified view. This can greatly affect the AF speed and the camera may take a longer time to focus.

With FlexiZone - Multi, it takes longer to focus.

- Depending on the shooting conditions, it may take longer to focus the subject. Use FlexiZone - Single or focus manually.

The continuous shooting speed is slow.

- Depending on the shutter speed, aperture, subject conditions, brightness, etc., the continuous shooting speed may become slower.

The maximum burst during continuous shooting is lower.

- If you shoot something that has fine detail (such as a field of grass), the file size will be larger and the actual maximum burst may be lower than the number mentioned on page 117.

ISO 100 cannot be set. ISO speed expansion cannot be selected.

- When [**4: Highlight tone priority**] is set to [**Disable**], ISO 100/125/160 can be set (p.145).
- If [**4: Highlight tone priority**] is set to [**Enable**], the settable ISO speed range will be ISO 200 - ISO 12800 (or up to ISO 6400 for movie shooting). Even if you expand the settable ISO speed range in [**ISO speed range**], you cannot set expanded ISO speeds (H).

The Auto Lighting Optimizer cannot be set.

- If [**4: Highlight tone priority**] is set to [**Enable**], the Auto Lighting Optimizer cannot be set. When [**4: Highlight tone priority**] is set to [**Disable**], then the Auto Lighting Optimizer can be set (p.145).

Even though I set a decreased exposure compensation, the image comes out bright.

- Set [**3: Auto Lighting Optimizer**] to [**Disable**]. When [**Low/Standard/High**] is set, even if you set a decreased exposure compensation or flash exposure compensation, the image may come out bright (p.140).

The multiple-exposure image is shot in **RAW** quality.

- When the image-recording quality is set to **M RAW** or **S RAW**, the multiple-exposure image will be recorded in **RAW** quality (p.181).

When I use the <Av> mode with flash, the shutter speed becomes slow.

- If you shoot at night when the background is dark, the shutter speed becomes slow automatically (slow-sync shooting) so that both the subject and background are properly exposed. To prevent a slow shutter speed, under [**2: Flash control**], set [**Flash sync. speed in Av mode**] to [**1/250-1/60sec. auto**] or [**1/250 sec. (fixed)**] (p.196).

The built-in flash is raised by itself.

- In shooting modes (<A+> <CA> <P> <M>) whose default setting is <A> (Auto flash), the built-in flash will rise automatically when necessary.

The built-in flash does not fire.

- If you shoot continuously with the built-in flash at short intervals, the flash may stop operating to protect the flash unit.

The external flash does not fire.

- If you use a non-Canon flash unit with Live View shooting, set [ 2: Silent LV shoot.] to [Disable] (p.231).

The external flash always fires at full output.

- If you use a flash unit other than an EX-series Speedlite, the flash will always be fired at full output (p.194).
- When the external Speedlite's [Flash metering mode] Custom Function is set to [TTL] (autoflash), the flash will always be fired at full output (p.202).

Flash exposure compensation cannot be set for the external Speedlite.

- If flash exposure compensation has already been set with the external Speedlite, flash exposure compensation cannot be set with the camera. When the external Speedlite's flash exposure compensation is canceled (set to 0), flash exposure compensation can be set with the camera.

High-speed sync cannot be set in the <Av> mode.

- Under [ 2: Flash control], set [Flash sync. speed in Av mode] to [Auto] (p.196).

The camera makes a noise when it is shaken.

- The built-in flash's pop-up mechanism moves slightly. This is normal and not a malfunction.

The shutter makes two shooting sounds during Live View shooting.

- If you use flash, the shutter will make two sounds each time you shoot (p.217).

During Live View and movie shooting, a white <🔥> or red <🔥> icon is displayed.

- It indicates that the camera's internal temperature is high. If the white <🔥> icon is displayed, the still photo's image quality may deteriorate. If the red <🔥> icon is displayed, it indicates that the Live View or movie shooting will soon stop automatically (p.249, 287).

I cannot shoot a movie.

- If [**3: Wi-Fi**] is set to [**Enable**], movie shooting is not possible. Before shooting movies, set [**Wi-Fi**] to [**Disable**].

Movie shooting stops by itself.

- If the card's writing speed is slow, movie shooting may stop automatically. If the compression method is set to [**IPB**], use a card with a reading/writing speed of at least 6 MB per sec. If the compression method is set to [**ALL-I**] (I-only), use a card with a reading/writing speed of at least 20 MB per sec. (p.3). To find out the card's reading/writing speed, refer to the card manufacturer's Web site.
- If the movie shooting time reaches 29 min. 59 sec., the movie shooting will stop automatically.

The ISO speed cannot be set for movie shooting.

- In shooting modes other than <M>, the ISO speed is set automatically. In the <M> mode, you can freely set the ISO speed (p.257).

The manually set ISO speed changes when switching to movie shooting.

- If you shoot a movie when [**Maximum: H (25600)**] is set with [**ISO speed range**] and ISO speed is set to “**H**” (25600), the ISO speed will switch to “**H**” (12800) (during movie shooting with manual exposure). Even if you switch back to still photo shooting, the ISO speed will not revert to the original setting.

The exposure changes during movie shooting.

- If you change the shutter speed or aperture during movie shooting, the changes in the exposure may be recorded.
- Zooming the lens during movie shooting can cause changes in the exposure regardless of whether the lens' maximum aperture changes or not. The changes in the exposure may be recorded as a result.

The subject looks distorted during movie shooting.

- If you move the camera to the left or right quickly (high-speed panning) or shoot a moving subject, the image may look distorted.

The image flickers or horizontal stripes appear during movie shooting.

- Flickering, horizontal stripes (noise), or irregular exposures can be caused by fluorescent light, LED bulbs, or other light sources during movie shooting. Also, changes in the exposure (brightness) or color tone may be recorded. In the <**M**> mode, a slow shutter speed may solve the problem.

When I shoot still photos during movie shooting, the movie shooting stops.

- Setting a lower image quality for still photos and shooting fewer continuous still photos may resolve the problem.

Time code is off.

- Shooting still photos during movie shooting will cause a discrepancy between the actual time and time code. When you want to edit a movie using time code, it is recommended not to shoot still photos during movie shooting.

Wi-Fi

Wi-Fi cannot be set.*

- If the camera is connected to a printer, computer, GPS receiver, or other device with an interface cable, Wi-Fi cannot be set ([**43: Wi-Fi**] will be grayed out). Disconnect the interface cable, then set the Wi-Fi.
- For details, refer to the Wi-Fi Function Instruction Manual.

* The EOS 70D (N) does not have the Wi-Fi function.

Operation Problems

I cannot change the setting with the < > dial, < > dial, or < >.

- Set the <**LOCK**> switch downward (lock release, p.48).
- Check the [**.Fn C.Fn III-2: Multi function lock**] setting (p.375).

The camera button/dial's function has changed.

- Check the [**.Fn C.Fn III-4: Custom Controls**] setting (p.383).

During touch screen operations, the beeper suddenly sounds softer.

- Check if your finger is blocking the speaker (p.20).

Touch screen operation is not possible.

- Check if [**43: Touch control**] is set to [**Standard**] or [**Sensitive**] (p.56).

Display Problems

The menu screen shows few tabs and options.

- In Basic Zone modes, certain tabs and menu options are not displayed. Set the shooting mode to a Creative Zone mode (p.52).

The file name's first character is an underscore (“_”).

- Set the color space to sRGB. If Adobe RGB is set, the first character will be an underscore (p.155).

The file name starts with “MVI_”.

- It is a movie file (p.152).

The file numbering does not start from 0001.

- If the card already contains recorded images, the image number may not start from 0001 (p.151).

The shooting date and time displayed is incorrect.

- Make sure the correct date and time has been set (p.37).
- Check the time zone and daylight saving time (p.37, 38).

The date and time is not in the picture.

- The shooting date and time does not appear in the picture. The date and time is instead recorded in the image data as shooting information. When printing, you can imprint the date and time in the picture by using the date and time recorded in the shooting information (p.351, 355).

[###] is displayed.

- If the card has recorded a number of images greater than the camera can display, [###] will be displayed (p.303).

The LCD monitor does not display a clear image.

- If the LCD monitor is dirty, use a soft cloth to clean it.
- In low or high temperatures, the LCD monitor display may seem slow or may look black. It will return to normal at room temperature.

[Eye-Fi settings] does not appear.

- **[Eye-Fi settings]** will appear only when an Eye-Fi card is inserted in the camera. If the Eye-Fi card has a write-protect switch set to the LOCK position, you will not be able to check the card's connection status or disable Eye-Fi transmission (p.401).

Playback Problems

Part of the image blinks in black.

- [**▶3: Highlight alert**] is set to **[Enable]** (p.294).

A red box is displayed on the image.

- [**▶3: AF point disp.**] is set to **[Enable]** (p.294).

The image cannot be erased.

- If the image is protected, it cannot be erased (p.320).

The movie cannot be played back.

- Movies edited with a computer using the provided ImageBrowser EX (p.456) or other software cannot be played back with the camera. However, video snapshot albums edited with EOS Video Snapshot Task (p.286) can be played on the camera.

When the movie is played back, camera operation noise can be heard.

- If you operate the camera's dials or lens during movie shooting, the operation noise will also be recorded. Using an external microphone (commercially available) is recommended (p.269).

The movie has still moments.

- During autoexposure movie shooting, if there is a drastic change in the exposure level, the recording will stop momentarily until the brightness stabilizes. If this happens, shoot with the <M> shooting mode (p.256).

No image appears on the TV screen.

- Make sure the HDMI cable or stereo AV cable's plug is inserted all the way in (p.316, 319).
- Set the video OUT system (NTSC/PAL) to the same video system as the TV set (p.319).

There are multiple movie files for a single movie shoot.

- If the movie file size reaches 4 GB, another movie file will be created automatically (p.266).

My card reader does not recognize the card.

- Depending on the card reader and computer OS used, SDXC cards may not be correctly recognized. If this occurs, connect your camera to the computer with the interface cable, then transfer the images to your computer using EOS Utility (provided software, p.456).

I cannot process the RAW image.

- **M RAW** and **S RAW** images cannot be processed with the camera. Use the provided software Digital Photo Professional to process the image (p.456).

I cannot resize the image.

- **S3** JPEG images and **RAW/M RAW/S RAW** images cannot be resized with the camera (p.333).

Sensor Cleaning Problems

The shutter makes a noise during sensor cleaning.

- If you selected [**Clean now** ], the shutter will make a noise, but no picture is taken (p.340).

Automatic sensor cleaning does not work.

- If you repeatedly turn the power switch <ON> / <OFF> at a short interval, the <> icon may not be displayed (p.35).

Printing-Related Problems

There are fewer printing effects than listed in the instruction manual.

- What is displayed on the screen differs depending on the printer. This instruction manual lists all the printing effects available (p.350).

Direct printing does not work.

- If [**Wi-Fi**] is set to [**Enable**], direct printing is not possible. Set [**Wi-Fi**] to [**Disable**], then connect the camera to the printer with an interface cable.

Computer Connection Problems

I cannot transfer images to a personal computer.

- Install the provided software (EOS DIGITAL Solution Disk CD-ROM) on the computer (p.456).
- If [**3: Wi-Fi**] is set to [**Enable**], the camera cannot be connected to a computer. Set [**Wi-Fi**] to [**Disable**], then connect the camera to the computer with an interface cable.

Error Codes

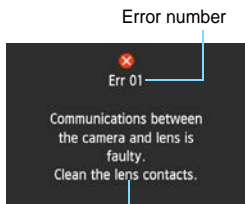

If there is a problem with the camera, an error message will appear. Follow the on-screen instructions.

Cause and countermeasures

Number	Error Message and Solution
01	Communications between the camera and lens is faulty. Clean the lens contacts.
	→ Clean the electrical contacts on the camera and lens, use a Canon lens, or remove and install the battery pack again (p.19, 20, 30).
02	Card cannot be accessed. Reinsert/change card or format card with camera.
	→ Remove and insert the card again, replace the card, or format the card (p.31, 57).
04	Cannot save images because card is full. Replace card.
	→ Replace the card, erase unnecessary images, or format the card (p.31, 57, 322).
05	The built-in flash could not be raised. Turn the camera off and on again.
	→ Operate the power switch (p.35).
06	Sensor cleaning could not be performed. Turn the camera off and on again.
	→ Operate the power switch (p.35).
10, 20 30, 40 50, 60 70, 80 99	An error prevented shooting. Turn the camera off and on again or re-install the battery.
	→ Operate the power switch, remove and install the battery pack again, or use a Canon lens (p.30, 35).

* If the error still persists, write down the error number and contact your nearest Canon Service Center.

Specifications

• Type

Type:	Digital, single-lens reflex, AF/AE camera with built-in flash
Recording media:	SD memory card, SDHC memory card*, SDXC memory card* * UHS-I cards compatible.
Image sensor size:	Approx. 22.5 x 15.0mm
Compatible lenses:	Canon EF lenses (including EF-S lenses) * Excluding EF-M lenses (35mm-equivalent focal length is approx. 1.6 times the lens focal length)
Lens mount:	Canon EF mount

• Image Sensor

Type:	CMOS sensor
Effective pixels:	Approx. 20.20 megapixels
Aspect ratio:	3:2
Dust delete feature:	Auto, Manual, Dust Delete Data appending

• Recording System

Recording format:	Design rule for Camera File System (DCF) 2.0
Image type:	JPEG, RAW (14-bit Canon original), RAW+JPEG simultaneous recording possible
Recorded pixels:	L (Large) : Approx. 20.00 megapixels (5472 x 3648) M (Medium) : Approx. 8.90 megapixels (3648 x 2432) S1 (Small 1) : Approx. 5.0 megapixels (2736 x 1824) S2 (Small 2) : Approx. 2.50 megapixels (1920 x 1280) S3 (Small 3) : Approx. 350,000 pixels (720 x 480) RAW : Approx. 20.0 megapixels (5472 x 3648) M-RAW : Approx. 11.0 megapixels (4104 x 2736) S-RAW : Approx. 5.0 megapixels (2736 x 1824)
Create/select a folder:	Possible
File numbering:	Continuous, Auto reset, Manual reset

• Image Processing During Shooting

Picture Style:	Auto, Standard, Portrait, Landscape, Neutral, Faithful, Monochrome, User Def. 1 - 3
----------------	---

Specifications

White balance:	Auto, Preset (Daylight, Shade, Cloudy, Tungsten light, White fluorescent light, Flash), Custom, Color temperature setting (approx. 2500-10000 K), White balance correction, and White balance bracketing possible * Flash color temperature information transmission enabled
Noise reduction:	Applicable to long exposures and high ISO speed shots
Automatic image brightness correction:	Auto Lighting Optimizer
Highlight tone priority:	Provided
Lens aberration correction:	Peripheral illumination correction, Chromatic aberration correction

• Viewfinder

Type:	Eye-level pentaprism
Coverage:	Vertical/Horizontal approx. 98% (with Eye point approx. 22mm)
Magnification:	Approx. 0.95x (-1 m ⁻¹ with 50mm lens at infinity)
Eye point:	Approx. 22mm (from eyepiece lens center at -1 m ⁻¹)
Built-in dioptic adjustment:	Approx. -3.0 - +1.0 m ⁻¹ (dpt)
Focusing screen:	Fixed
Grid display:	Provided
Electronic level:	Displayable before and during shooting
Mirror:	Quick-return type
Depth-of-field preview:	Provided

• Autofocus

Type:	TTL secondary image-registration, phase-difference detection with the dedicated AF sensor
AF points:	19 (All cross-type focusing*) * Except with certain lenses.
Focusing brightness range:	EV -0.5 - 18 (with center AF point, at room temperature, ISO 100)
Focus operation:	One-Shot AF, AI Servo AF, AI Focus AF, Manual focusing (MF)
AF area selection mode:	Single-point AF (Manual selection), Zone AF (Manual zone selection), 19-point automatic selection AF
AI Servo AF characteristics:	Tracking sensitivity, Acceleration/deceleration tracking
AF fine adjustment:	AF Microadjustment (All lenses by same amount or Adjust by lens)
AF-assist beam:	Small series of flashes fired by built-in flash

• Exposure Control

Metering modes:	63-zone TTL full-aperture metering <ul style="list-style-type: none"> • Evaluative metering (linked to all AF points) • Partial metering (approx. 7.7% of viewfinder at center) • Spot metering (approx. 3.0% of viewfinder at center) • Center-weighted average metering
Metering brightness range:	EV 1 - 20 (at room temperature, ISO 100)
Exposure control:	Program AE (Scene Intelligent Auto, Flash Off, Creative Auto, Special scene [Portrait, Landscape, Close-up, Sports, Night Portrait, Handheld Night Scene, HDR Backlight Control], Program), Shutter-priority AE, Aperture-priority AE, Manual exposure, Bulb exposure
ISO speed: (Recommended exposure index)	Basic Zone modes*: ISO 100 - ISO 6400 set automatically * Landscape: ISO 100 - ISO 1600 set automatically, Handheld Night Scene: ISO 100 - ISO 12800 set automatically P, Tv, Av, M, B: Auto ISO, ISO 100 - ISO 12800 (in 1/3- or whole-stop increments), or ISO expansion to H (equivalent to ISO 25600)
ISO speed settings:	ISO speed range, Auto ISO range, and Auto ISO minimum shutter speed settable
Exposure compensation:	Manual: ± 5 stops in 1/3- or 1/2-stop increments AEB: ± 3 stops in 1/3- or 1/2-stop increments (can be combined with manual exposure compensation)
AE lock:	Auto: Applied in One-Shot AF mode with evaluative metering when focus is achieved Manual: By AE lock button

• HDR Shooting

Dynamic range adjustment:	Auto, ± 1 EV, ± 2 EV, ± 3 EV
Auto image align:	Possible

• Multiple Exposures

Number of multiple exposures:	2 to 9 exposures
Multiple-exposure control:	Additive, Average

• Shutter

Type:	Electronically-controlled, focal-plane shutter
-------	--

Shutter speeds: 1/8000 sec. to 30 sec. (total shutter speed range; available range varies by shooting mode), Bulb, X-sync at 1/250 sec.

• Drive System

Drive modes: Single shooting, High-speed continuous shooting, Low-speed continuous shooting, Silent single shooting, Silent continuous shooting, 10-sec. self-timer/remote control, 2-sec. self-timer/remote control

Continuous shooting speed: High-speed continuous shooting: Max. approx. 7.0 shots/sec.
Low-speed continuous shooting: Max. approx. 3.0 shots/sec.
Silent continuous shooting : Max. approx. 3.0 shots/sec.

Max. burst: JPEG Large/Fine: Approx. 40 shots (approx. 65 shots)
RAW: Approx. 15 shots (approx. 16 shots)
RAW+JPEG Large/Fine: Approx. 8 shots (approx. 8 shots)
* Figures are based on Canon's testing standards (ISO 100 and Standard Picture Style) and an 8 GB card.
* Figures in parentheses apply to an UHS-I compatible 8 GB card based on Canon's testing standards.

• Flash

Built-in flash: Retractable, auto pop-up flash
Guide No.: Approx. 12/39.4 (ISO 100, in meters/feet)
Flash coverage: Approx. 17mm lens angle of view
Recycling time approx. 3 sec.

External Speedlite: Compatible with EX-series Speedlites

Flash metering: E-TTL II autofocus

Flash exposure compensation: ± 3 stops in 1/3- or 1/2-stop increments

FE lock: Provided

PC terminal: None

Flash control: Built-in flash function settings, external Speedlite function settings, external Speedlite Custom Function settings
Wireless flash control via optical transmission

• Live View Shooting

Aspect ratio: 3:2, 4:3, 16:9, 1:1

Focus methods: Dual Pixel CMOS AF system/Contrast-detection AF system (Face+Tracking, FlexiZone-Multi, FlexiZone-Single), Phase-difference detection with the dedicated AF sensor (Quick mode), Manual focus (approx. 5x and 10x magnified view possible for focus check)

Continuous AF:	Provided
Focusing brightness range:	EV 0-18 (at room temperature, ISO 100)
Metering modes:	Evaluative metering (315 zones), Partial metering (approx. 10.3% of Live View screen), Spot metering (approx. 2.6% of Live View screen), Center-weighted average metering
Metering brightness range:	EV 0 - 20 (at room temperature, ISO 100)
Creative filters:	Grainy B/W, Soft focus, Fish-eye effect, Art bold effect, Water painting effect, Toy camera effect, Miniature effect
Silent shooting:	Provided (Mode 1 and 2)
Touch shutter:	Provided
Grid display:	Three types

• Movie Shooting

Recording format:	MOV
Movie:	MPEG-4 AVC / H.264 Variable (average) bit rate
Audio:	Linear PCM
Recording size and frame rate:	1920x1080 (Full HD): 30p/25p/24p 1280x720 (HD) : 60p/50p 640x480 (SD) : 30p/25p * 30p: 29.97 fps, 25p: 25.00 fps, 24p: 23.98 fps, 60p: 59.94 fps, 50p: 50.00 fps
Compression method:	ALL-I (I-only), IPB
File size:	1920x1080 (30p/25p/24p) / IPB : Approx. 235 MB/min. 1920x1080 (30p/25p/24p) / ALL-I: Approx. 685 MB/min. 1280x720 (60p/50p) / IPB : Approx. 205 MB/min. 1280x720 (60p/50p) / ALL-I : Approx. 610 MB/min. 640x480 (30p/25p) / IPB : Approx. 78 MB/min. * Card reading/writing speed necessary for movie shooting: IPB: at least 6 MB per sec./ALL-I: at least 20 MB per sec.
Focusing:	Same as focusing with Live View shooting * Quick mode disabled during movie shooting
Digital zoom:	Approx. 3x-10x
Metering modes:	Center-weighted average and Evaluative metering with the image sensor * Automatically set by the focus method.
Metering brightness range:	EV 0 - 20 (at room temperature, ISO 100)

Exposure control:	Autoexposure shooting (Program AE for movies) and manual exposure
Exposure compensation:	±3 stops in 1/3-stop increments (±5 stops for still photos)
ISO speed: (Recommended exposure index)	For autoexposure shooting: 1. ISO 100 - ISO 6400 set automatically. In Creative Zone modes, the upper limit is expandable to H (equivalent to ISO 12800). For manual exposure shooting: Auto ISO (ISO 100 - ISO 6400 set automatically), ISO 100 - ISO 6400 set manually (1/3- and whole-stop increments), expandable to H (equivalent to ISO 12800)
Time code:	Supported
Drop frames:	Compatible with 60p/30p
Video snapshots:	Settable to 2 sec./4 sec./8 sec.
Sound recording:	Built-in stereo microphone, external stereo microphone terminal provided Sound-recording level adjustable, wind filter provided, attenuator provided
Grid display:	Three types
Still photo shooting:	Possible

• LCD Monitor

Type:	TFT color, liquid-crystal monitor
Monitor size and dots:	Wide 7.7 cm (3.0-in) (3:2) with approx. 1.04 million dots
Brightness adjustment:	Manual (7 levels)
Electronic level:	Provided
Interface languages:	25
Touch screen technology:	Capacitive sensing
Feature guide / Help:	Displayable

• Playback

Image display formats:	Single image display, Single image + Info display (Basic info, shooting info, histogram), 4-image index, 9-image index
Highlight alert:	Overexposed highlights blink
AF point display:	Possible
Grid display:	Three types
Zoom magnification:	Approx. 1.5x - 10x
Image browsing methods:	Single image, jump by 10 or 100 images, by shooting date, by folder, by movies, by stills, by rating
Image rotate:	Possible

Rating:	Provided
Movie playback:	Enabled (LCD monitor, video/audio OUT, HDMI OUT), built-in speaker
Slide show:	All images, by date, by folder, by movies, by stills, by rating
Background music:	Selectable for slide shows and movie playback
Image protect:	Possible

• Post-Processing of Images

In-camera RAW image processing:	Brightness correction, White balance, Picture Style, Auto Lighting Optimizer, High ISO speed noise reduction, JPEG image-recording quality, Color space, Peripheral illumination correction, Distortion correction, Chromatic aberration correction
Resize:	Possible
Creative filters:	Grainy B/W, Soft focus, Fish-eye effect, Art bold effect, Water painting effect, Toy camera effect, Miniature effect

• Direct Printing

Compatible printers:	PictBridge-compatible printers
Printable images:	JPEG and RAW images
Print ordering:	DPOF Version 1.1 compatible

• Custom Functions

Custom Functions:	23
My Menu registration:	Possible
Custom shooting modes:	Register under Mode Dial C
Copyright information:	Entry and inclusion enabled

• Interface

Audio/video OUT/Digital terminal:	Analog video (Compatible with NTSC/PAL)/stereo audio output Computer communication, Direct printing (Hi-Speed USB or equivalent), GPS Receiver GP-E2 connection
HDMI mini OUT terminal:	Type C (Auto switching of resolution), CEC-compatible
External microphone IN terminal:	3.5 mm diameter stereo mini-jack
Remote control terminal:	For Remote Switch RS-60E3
Wireless remote control:	Compatible with Remote Controller RC-6
Eye-Fi card:	Compatible

• Power

Battery:	Battery Pack LP-E6 (Quantity 1) * AC power can be supplied via AC Adapter Kit ACK-E6. * With Battery Grip BG-E14 attached, size-AA/LR6 batteries can be used.
Battery information:	Remaining capacity, Shutter count, Recharge performance, and Battery registration possible
Number of possible shots: (Based on CIPA testing standards)	With viewfinder shooting: Approx. 920 shots at room temperature (23°C/73°F), approx. 850 shots at low temperatures (0°C/32°F) With Live View shooting: Approx. 210 shots at room temperature (23°C/73°F), approx. 200 shots at low temperatures (0°C/32°F)
Movie shooting time:	Approx. 1 hr. 20 min. at room temperature (23°C/73°F), approx. 1 hr. 20 min. at low temperatures (0°C/32°F) * With a fully-charged Battery Pack LP-E6.

• Dimensions and Weight

Dimensions (W x H x D):	Approx. 139.0 x 104.3 x 78.5 mm / 5.5 x 4.1 x 3.1 in.
Weight (EOS 70D (W)):	Approx. 755 g / 26.7 oz. (CIPA Guidelines), approx. 675 g / 23.8 oz. (Body only)
Weight (EOS 70D (N)):	Approx. 750 g / 26.5 oz. (CIPA Guidelines), approx. 670 g / 23.7 oz. (Body only)

• Operation Environment

Working temperature range:	0°C - 40°C / 32°F - 104°F
Working humidity:	85% or less

• Battery Pack LP-E6

Type:	Rechargeable lithium-ion battery
Rated voltage:	7.2 V DC
Battery capacity:	1800 mAh
Dimensions (W x H x D):	Approx. 38.4 x 21.0 x 56.8 mm / 1.5 x 0.8 x 2.2 in.
Weight:	Approx. 80g / 23.6 oz.

• Battery Charger LC-E6

Compatible battery:	Battery Pack LP-E6
Recharging time:	Approx. 2 hr. 30 min.
Rated input:	100 - 240 V AC (50/60 Hz)
Rated output:	8.4 V DC / 1.2 A

Working temperature range:	5°C - 40°C / 41°F - 104°F
Working humidity:	85% or less
Dimensions (W x H x D):	Approx. 69.0 x 33.0 x 93.0 mm / 1.5 x 0.8 x 3.7 in.
Weight:	Approx. 130g / 23.6 oz.

• Battery Charger LC-E6E

Compatible battery:	Battery Pack LP-E6
Power cord length:	Approx. 1 m / 3.3 ft.
Recharging time:	Approx. 2 hr. 30 min.
Rated input:	100 - 240 V AC (50/60 Hz)
Rated output:	8.4 V DC / 1.2 A
Working temperature range:	5°C - 40°C / 41°F - 104°F
Working humidity:	85% or less
Dimensions (W x H x D):	Approx. 69.0 x 33.0 x 93.0 mm / 2.7 x 1.3 x 3.7 in.
Weight:	Approx. 125 g / 4.4 oz. (excluding power cord)

• EF-S18-55mm f/3.5-5.6 IS STM

Angle of view:	Diagonal extent: 74°20' - 27°50' Horizontal extent: 64°30' - 23°20' Vertical extent: 45°30' - 15°40'
Lens construction:	13 elements in 11 groups
Minimum aperture:	f/22 - 36
Closest focusing distance:	0.25 m / 0.82 ft. (from image sensor plane)
Max. magnification:	0.36x (at 55 mm)
Field of view:	199 x 129 - 63 x 42 mm / 7.83 x 5.08 - 2.48 x 1.65 in. (at 0.25 m / 0.82 ft.)
Image Stabilizer:	Lens shift type
Filter size:	58 mm
Lens cap:	E-58 II
Max. diameter x length:	Approx. 69.0 x 75.2 mm / 2.72 x 2.96 in.
Weight:	Approx. 205 g / 7.2 oz.
Hood:	EW-63C (sold separately)
Case:	LP1016 (sold separately)

• EF-S18-135mm f/3.5-5.6 IS STM

Angle of view:	Diagonal extent: 74°20' - 11°30' Horizontal extent: 64°30' - 9°30' Vertical extent: 45°30' - 6°20'
Lens construction:	16 elements in 12 groups
Minimum aperture:	f/22 - 36

Closest focusing distance*:	At 18 mm focal length: 0.39 m / 1.28 ft. (Approx. 372 x 248 mm / 14.6 x 9.8 in. field of view) At 135 mm focal length: 0.39 m / 1.28 ft. (Approx. 80 x 53 mm / 3.1 x 2.1 in. field of view) * Distance from image sensor plane
Max. magnification:	0.28x (at 135 mm)
Image Stabilizer:	Lens shift type
Filter size:	67 mm
Lens cap:	E-67 II
Max. diameter x length:	Approx. 76.6 x 96.0 mm / 3.0 x 3.8 in.
Weight:	Approx. 480 g / 16.9 oz.
Hood:	EW-73B (sold separately)
Case:	LP1116 (sold separately)

• EF-S18-200mm f/3.5-5.6 IS

Angle of view:	Diagonal extent: 74°20' - 7°50' Horizontal extent: 64°30' - 6°30' Vertical extent: 45°30' - 4°20'
Lens construction:	16 elements in 12 groups
Minimum aperture:	f/22 - 36
Closest focusing distance:	0.45 m / 1.48 ft. (From image sensor plane)
Max. magnification:	0.24x (at 200 mm)
Field of view:	452 x 291 - 93 x 62 mm / 17.8 x 11.5 - 3.7 x 2.4 in. (at 0.45 m / 1.48 ft.)
Image Stabilizer:	Lens shift type
Filter size:	72 mm
Lens cap:	E-72 II
Max. diameter x length:	Approx. 78.6 x 102.0 mm / 3.1 x 4.0 in.
Weight:	Approx. 595 g / 21.0 oz.
Hood:	EW-78D (sold separately)
Case:	LP1116 (sold separately)

- All the data above is based on Canon's testing standards and CIPA (Camera & Imaging Products Association) testing standards and guidelines.
- Dimensions, maximum diameter, length and weight listed above are based on CIPA Guidelines (except weight for camera body only).
- Product specifications and the exterior are subject to change without notice.
- If a problem occurs with a non-Canon lens attached to the camera, consult the respective lens manufacturer.

Handling Precautions: EF-S18-55mm f/3.5-5.6 IS STM, EF-S18-135mm f/3.5-5.6 IS STM

The kit lenses use a stepping motor that drives the focus lens. The motor controls the focus lens even during zooming.

1. When the camera is OFF

The motor does not operate while the camera is OFF or when the camera is OFF due to the auto power off function. Therefore, users must be aware of the following points.

- Manual focusing is not possible.
- During zooming, inaccurate focusing may occur.

2. When the lens is in sleep mode

If not operated for a certain period of time, this lens will enter sleep mode in order to save power, apart from the camera's auto power off. To exit sleep mode, press the shutter button halfway.

In sleep mode, the motor will not operate even if the camera is ON. Therefore, users must be aware of the following points.

- Manual focusing is not possible.
- During zooming, inaccurate focusing may occur.

3. During initial reset

When the camera is turned ON or when the camera is turned ON by pressing the shutter button halfway when the camera is OFF due to the auto power off function*¹, the lens performs an initial reset of the focus lens.

- Although the image in the viewfinder will appear out of focus during the initial reset, this is not a malfunction.
- Wait approx. 1 second*² after the initial reset has completed before shooting.

*1: Applicable to the following EF-S lens compatible digital SLR cameras:
EOS 7D, EOS 60D, EOS 60Da, EOS 50D, EOS 40D, EOS 30D, EOS 20D,
EOS 20Da, EOS REBEL T3i/600D, EOS REBEL T2i/550D, EOS REBEL T1i/
500D, EOS REBEL XSi/450D, EOS REBEL T3/1100D, EOS REBEL XS/
1000D, EOS DIGITAL REBEL XTi/400D DIGITAL, EOS DIGITAL REBEL XT/
350D DIGITAL, EOS DIGITAL REBEL/300D DIGITAL

*2: The initial reset time varies depending on the camera used.

Trademarks

- Adobe is a trademark of Adobe Systems Incorporated.
- Microsoft and Windows are trademarks or registered trademarks of Microsoft Corporation in the United States and/or other countries.
- Macintosh and Mac OS are trademarks of Apple Inc., registered in the U.S. and other countries.
- SDXC logo is a trademark of SD-3C, LLC.
- HDMI, HDMI logo, and High-Definition Multimedia Interface are trademarks or registered trademarks of HDMI Licensing LLC.
- All other trademarks are the property of their respective owners.

About MPEG-4 Licensing

"This product is licensed under AT&T patents for the MPEG-4 standard and may be used for encoding MPEG-4 compliant video and/or decoding MPEG-4 compliant video that was encoded only (1) for a personal and non-commercial purpose or (2) by a video provider licensed under the AT&T patents to provide MPEG-4 compliant video. No license is granted or implied for any other use for MPEG-4 standard."

* Notice displayed in English as required.

Use of Genuine Canon Accessories Is Recommended

This product is designed to achieve excellent performance when used with genuine Canon accessories.

Canon shall not be liable for any damage to this product and/or accidents such as fire, etc., caused by the malfunction of non-genuine Canon accessories (e.g., a leakage and/or explosion of a battery pack). Please note that this warranty does not apply to repairs arising out of the malfunction of non-genuine Canon accessories, although you may request such repairs on a chargeable basis.

-  Battery Pack LP-E6 is dedicated to Canon products only. Using it with an incompatible battery charger or product may result in malfunction or accidents for which Canon cannot be held liable.

Safety Warnings

Follow these safeguards and use the equipment properly to prevent injury, death, and material damage.

Preventing Serious Injury or Death

- To prevent fire, excessive heat, chemical leakage, and explosions, follow the safeguards below:
 - Do not use any batteries, power sources, and accessories not specified in this booklet. Do not use any home-made or modified batteries.
 - Do not short-circuit, disassemble, or modify the battery pack or back-up battery. Do not apply heat or apply solder to the battery pack or back-up battery. Do not expose the battery pack or back-up battery to fire or water. And do not subject the battery pack or back-up battery to strong physical shock.
 - Do not install the battery pack or back-up battery in reversed polarity (+ -). Do not mix new and old or different types of batteries.
 - Do not recharge the battery pack outside the allowable ambient temperature range of 0°C - 40°C (32°F - 104°F). Also, do not exceed the recharging time.
 - Do not insert any foreign metallic objects into the electrical contacts of the camera, accessories, connecting cables, etc.
- Keep the back-up battery away from children. If a child swallows the battery, consult a physician immediately. (Battery chemicals may harm the stomach and intestines.)
- When disposing of a battery pack or back-up battery, insulate the electrical contacts with tape to prevent contact with other metallic objects or batteries. This is to prevent fire or an explosion.
- If excessive heat, smoke, or fumes are emitted during battery pack recharging, immediately unplug the battery charger from the power outlet to stop the recharging and prevent a fire.
- If the battery pack or back-up battery leaks, changes color, deforms, or emits smoke or fumes, remove it immediately. Be careful not to get burned in the process.
- Prevent any battery leakage from contacting your eyes, skin, and clothing. It can cause blindness or skin problems. If the battery leakage contacts your eyes, skin, or clothing, flush the affected area with lots of clean water without rubbing it. See a physician immediately.
- During the recharging, keep the equipment away from the reach of children. The cord can accidentally choke the child or give an electrical shock.
- Do not leave any cords near a heat source. It can deform the cord or melt the insulation and cause a fire or electrical shock.
- Do not hold the camera in the same position for long periods of time. Even if the camera does not feel too hot, prolonged contact with the same body part may cause skin redness, blistering or low-temperature contact burns. The use of a tripod is recommended for people with circulation problems or very sensitive skin, or when using the camera in very hot places.
- Do not fire the flash at someone driving a car. It may cause an accident.
- Do not fire the flash near a person's eyes. It may impair the person's vision. When using flash to photograph an infant, keep at least 1 meter/3.3 feet away.

-
- Before storing the camera or accessory when not in use, remove the battery pack and disconnect the power plug. This is to prevent electrical shock, heat generation, and fire.
-
- Do not use the equipment where there is flammable gas. This is to prevent an explosion or fire.
-
- If you drop the equipment and the casing breaks open to expose the internal parts, do not touch the internal parts due to the possibility of electrical shock.
-
- Do not disassemble or modify the equipment. High-voltage internal parts can cause electrical shock.
-
- Do not look at the sun or an extremely bright light source through the camera or lens. Doing so may damage your vision.
-
- Keep the camera from the reach of small children. The neck strap can accidentally choke the child.
-
- Do not store the equipment in dusty or humid places. This is to prevent fire and electrical shock.
-
- Before using the camera inside an airplane or hospital, check if it is allowed. Electromagnetic waves emitted by the camera may interfere with the plane's instruments or the hospital's medical equipment.
-
- To prevent fire and electrical shock, follow the safeguards below:
 - Always insert the power plug all the way in.
 - Do not handle a power plug with wet hands.
 - When unplugging a power plug, grasp and pull the plug instead of the cord.
 - Do not scratch, cut, or excessively bend the cord or put a heavy object on the cord. Also do not twist or tie the cords.
 - Do not connect too many power plugs to the same power outlet.
 - Do not use a cord whose insulation has been damaged.
-
- Occasionally unplug the power plug and use a dry cloth to clean off the dust around the power outlet. If the surrounding is dusty, humid, or oily, the dust on the power outlet may become moist and short-circuit the outlet to cause a fire.

Preventing Injury or Equipment Damage

- Do not leave equipment inside a car under the hot sun or near a heat source. The equipment may become hot and cause skin burns.
- Do not carry the camera around while it is attached to a tripod. Doing so may cause injury. Also make sure the tripod is sturdy enough to support the camera and lens.
- Do not leave a lens or lens-attached camera under the sun without the lens cap attached. Otherwise, the lens may concentrate the sun's rays and cause a fire.
- Do not cover or wrap the battery-recharging apparatus with a cloth. Doing so may trap heat within and cause the casing to deform or catch fire.
- If you drop the camera in water or if water or metal fragments enter inside the camera, promptly remove the battery pack and back-up battery. This is to prevent fire and electrical shock.
- Do not use or leave the battery pack or back-up battery in a hot environment. Doing so may cause battery leakage or a shorter battery life. The battery pack or back-up battery can also become hot and cause skin burns.
- Do not use paint thinner, benzene, or other organic solvents to clean the equipment. Doing so may cause fire or a health hazard.

If the product does not work properly or requires repair, contact your dealer or your nearest Canon Service Center.

Digital Camera Model DS126411 / DS126412 Systems

This device complies with Part 15 of the FCC Rules. Operation is subject to the following two conditions: (1) This device may not cause harmful interference, and (2) this device must accept any interference received, including interference that may cause undesired operation.

Note: This equipment has been tested and found to comply with the limits for class B digital devices, pursuant to Part 15 of the FCC Rules. These limits are designed to provide reasonable protection against harmful interference in a residential installation. This equipment generates, uses and can radiate radio frequency energy and, if not installed and used in accordance with the instructions, may cause harmful interference to radio communications. However, there is no guarantee that interference will not occur in a particular installation. If this equipment does cause harmful interference to radio or television reception, which can be determined by turning the equipment off and on, the user is encouraged to try to correct the interference by one or more of the following measures:

- Reorient or relocate the receiving antenna.
- Increase the separation between the equipment and receiver.
- Connect the equipment into an outlet on a circuit different from that to which the receiver is connected.
- Consult the dealer or an experienced radio/TV technician for help.

The cable with the ferrite core provided with the digital camera must be used with this equipment in order to comply with Class B limits in Subpart B of Part 15 of the FCC rules.

Do not make any changes or modifications to the equipment unless otherwise specified in the manual. If such changes or modifications should be made, you could be required to stop operation of the equipment.

Canon U.S.A. Inc.
One Canon Plaza, Lake Success, NY 11042, U.S.A.
Tel No. (516)328-5600

This Class B digital apparatus complies with Canadian ICES-003.



When connecting to and using a household power outlet, use only AC Adapter Kit ACK-E6 (rated input: 100-240 V AC 50/60 Hz, rated output: 8.0 V DC). Using anything else can cause fire, overheating, or electrical shock.

IMPORTANT SAFETY INSTRUCTIONS

1. **SAVE THESE INSTRUCTIONS** — This manual contains important safety and operating instructions for Battery Charger LC-E6 & LC-E6E.
2. Before using the charger, read all instructions and cautionary remarks on (1) the charger, (2) the battery pack, and (3) the product using the battery pack.
3. **CAUTION** — To reduce risk of injury, charge only the Battery Pack LP-E6. Other types of batteries may burst, causing personal injury and other damage.
4. Do not expose the charger to rain or snow.
5. Use of an attachment not recommended or sold by Canon may result in fire, electric shock, or personal injury.
6. To reduce risk of damage to electric plug and cord, pull by plug rather than by cord when disconnecting charger.
7. Make sure cord is located so that it will not be stepped on, tripped over, or otherwise subjected to damage or stress.
8. Do not operate the charger with damaged cord or plug - replace them immediately.
9. Do not operate the charger if it has received a sharp blow, been dropped, or otherwise damaged in any way; take it to a qualified serviceman.
10. Do not disassemble the charger; take it to a qualified serviceman when service or repair is required. Incorrect reassembly may result in a risk of electric shock or fire.
11. To reduce risk of electric shock, unplug charger from outlet before attempting any maintenance or cleaning.

MAINTENANCE INSTRUCTION

Unless otherwise stated in this manual, there are no user serviceable parts inside. Refer servicing to qualified serviceman.



USA and Canada only:

The Lithium ion/polymer battery that powers the product is recyclable. Please call 1-800-8-BATTERY for information on how to recycle this battery.

For CA, USA only

Included lithium battery contains Perchlorate Material – special handling may apply. See www.dtsc.ca.gov/hazardouswaste/perchlorate/ for details.

CAUTION

RISK OF EXPLOSION IF BATTERY IS REPLACED BY AN INCORRECT TYPE.
DISPOSE OF USED BATTERIES ACCORDING TO LOCAL REGULATION.

Viewing the Camera Instruction Manual CD-ROM



The Camera Instruction Manual CD-ROM contains the following electronic manuals (PDF):

- **Camera Instruction Manual**

Explains all the camera functions and procedures, including basic content.

- **Wi-Fi Function Instruction Manual**

Explains all the Wi-Fi functions and procedures, including basic content.

- **Quick Reference Guide**

Simple and portable guide covering basic function settings, shooting instructions, and playback instructions.

Viewing the Camera Instruction Manual on the CD-ROM

To view the instruction manuals (PDF files), Adobe Reader 6.0 or higher must be installed in your computer. Adobe Reader can be downloaded free from the Internet. After installing Adobe Reader, follow the procedure below.

1 Insert the “CAMERA INSTRUCTION MANUAL” CD-ROM into your computer.

2 Double-click the CD-ROM icon.

- With Windows, double-click on the CD-ROM icon in [(My) Computer]. With Macintosh, double-click on the CD-ROM icon on the desktop.
- The icon displayed will differ depending on your computer's operating system.





3 Double-click the **START** file.

- ▶ The screen shown in step 4 will appear.
- The icon displayed will differ depending on your computer's operating system.

4 Select the language.



5 Click on the manual you want to view.

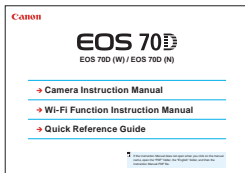

- ▶ The instruction manual in your language will be displayed.



- You can save the PDF file to your computer.
- All the instruction manuals (PDF files) have page links to make it quick to find the desired page. Click on a page number in the Contents or Index and that page will appear.
- To learn how to use Adobe Reader, refer to Adobe Reader's Help section.

Downloading Images to a Computer

You can use the provided software to download the images in the camera to your computer. There are two ways to do this.

Downloading by Connecting the Camera to the Computer

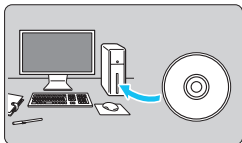

1 Install the software (p.458).

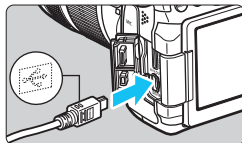

2 Use the provided interface cable to connect the camera to your computer.

- Use the interface cable provided with the camera.
- Connect the cable to the camera's <DIGITAL> terminal with the cable plug's <↔> icon facing the front of the camera.
- Connect the cord's plug to the computer's USB terminal.

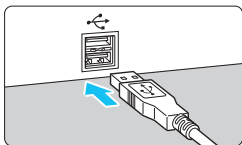

3 Use EOS Utility to transfer the images.

- For details, refer to the Software Instruction Manual on the CD-ROM (p.459).

 If [**Wi-Fi**] is set to [**Enable**], the images cannot be downloaded to a computer. Set it to [**Disable**], then connect the interface cable.

Downloading Images with a Card Reader

You can use a card reader to download images/movies to a computer.

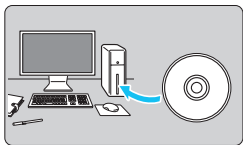

1 Install the software (p.458).

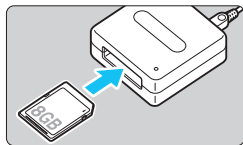

2 Insert the card into the card reader.

3 Use Canon software to download the images.

- ▶ Use Digital Photo Professional.
- ▶ Use ImageBrowser EX.
- For details, refer to the Software Instruction Manual on the CD-ROM (p.459).



When downloading images from the camera to your computer, with a card reader without using Canon software, copy the DCIM folder on the card to your computer.

Software Overview



EOS DIGITAL Solution Disk

This disk contains various software for EOS DIGITAL cameras.

EOS Utility

With the camera connected to a computer, EOS Utility enables you to transfer still photos and movies shot with the camera to the computer. You can also use this software to set various camera settings and shoot remotely with the computer connected to the camera. Also, you can copy background music tracks, such as EOS Sample Music*, to the card.

* Background music can be used when you play a video snapshot album or slide show on your camera.

Digital Photo Professional

This software is recommended for users who mainly shoot RAW images. You can quickly view, edit, process and print RAW images. You can also edit JPEG images while retaining the original images.

ImageBrowser EX

This software is recommended for users who mainly shoot JPEG images. You can easily view and play still photos, movies, and video snapshot albums and also print JPEG images. Add-on features such as EOS Video Snapshot Task (p.286) can also be downloaded from the Internet.

 Note that the software ZoomBrowser EX/ImageBrowser provided with previous cameras does not support still photos and movie files shot with this camera (it is not compatible). Use ImageBrowser EX provided with this camera.

Picture Style Editor

You can edit Picture Styles and create and save original Picture Style files. This software is aimed at advanced users who are experienced in processing images.

Installing the Software

- **Do not connect the camera to your computer before you install the software. The software will not be installed correctly.**
- Even if your computer already has ImageBrowser EX installed, install ImageBrowser EX included on the CD-ROM that came with this camera. It is the latest version with features optimized for your camera. You can also use the auto update feature to add the latest functions.
- Even for software other than ImageBrowser EX, if a previous version is installed, update it by following the steps below to install the software that came with the camera. (The newer version will overwrite the previous version.)

1 Insert EOS DIGITAL Solution Disk (CD-ROM).

- For Macintosh, double-click to open the CD-ROM icon displayed on the desktop, then double-click on [**Canon EOS Digital Installer**].
- When a screen to select where you live or a language appears, follow the on-screen instructions.

2 Click [**Easy Installation**] and follow the on-screen instructions to install.

- For Macintosh, click [**Install**].
- If install screen for “Microsoft Silverlight” is displayed during installation, install “Microsoft Silverlight”.

3 Click [**Restart**] and remove the CD-ROM after the computer restarts.

- When the computer has restarted, the installation is complete.

Software Instruction Manual



Contains the Software Instruction Manuals.



Copying and Viewing the Software Instruction Manual PDFs

- 1 Insert the [Software INSTRUCTION MANUAL] CD-ROM into your computer.
- 2 Double-click the CD-ROM icon.
 - For Windows, the icon is displayed in [(My) Computer].
 - For Macintosh, the icon is displayed on the desktop.
- 3 Copy the [English] folder to your computer.
 - Instruction Manual PDFs with the names below are copied.

	Windows	Macintosh
EOS Utility	EUx.xW_E_xx	EUx.xM_E_xx
Digital Photo Professional	DPPx.xW_E_xx	DPPx.xM_E_xx
ImageBrowser EX	IBXx.x_E_xx	
Picture Style Editor	PSEx.xW_E_xx	PSEx.xM_E_xx

- 4 Double-click the copied PDF file.
 - Adobe Reader (most recent version recommended) must be installed on your computer.
 - Adobe Reader can be downloaded free from the Internet.

Index

- Numerics**
- 10- or 2-sec. self-timer 113
- 1280x720 265
- 1920x1080 265
- 19-point AF auto selection 103
- 4- or 9-image index display 296
- 640x480 265
- A**
-  (Scene Intelligent Auto) 72
- AC Adapter Kit 400
- Access lamp 32
- Accessories 4
- Adobe RGB 155
- AE lock 170
- AEB
- (Auto Exposure Bracketing) .. 168, 365
- AF
 - AF area selection mode 103
 - AF method 233, 273
 - AF Microadjustment 377
 - AF operation 100
 - AF point 103
 - AF point selection 105, 386
 - AF-assist beam 102, 371
 - Automatic selection 103, 107
 - Beep (Beeper) 59
 - Difficulty focusing 109, 241
 - Manual focusing (MF) 110, 247
 - Out of focus 43, 44, 241
 - Recomposing 75
- AF area selection mode 103
- AF point 103
- AF-ON (AF start) button 45
- AI FOCUS (AI Focus AF) 102
- AI SERVO (AI Servo AF) 75, 101
 - Tracking sensitivity 368, 369
- ALL-I (I-only) 265
- Ambience-based shots 92
- Aperture-priority AE 162
- Art bold effect 226, 337
- Aspect ratio 229
- Attenuator 268
- Auto Lighting Optimizer 140
- Auto playback 312
- Auto power off 35, 59
- Auto reset 152
- Auto rotate 325
- Autofocus → AF
- Automatic selection of
- AF point 103, 107
- Av (Aperture-priority AE) 162
- A/V OUT
- (Audio/video output) 306, 316, 319
- B**
- B (Bulb) 171
- Background music 315
- Basic Zone modes 24
- Battery 28, 30, 36
- Battery Grip 36, 416
- Beep (Beeper) 59
- Black-and-white image ... 92, 127, 131
- Bracketing 139, 168
- Bulb exposures 171
- C**
- C (Custom shooting) 390
-  (Creative Auto) 78
- Cable 4, 316, 319, 416, 454
- Camera
 - Camera shake 182
 - Clearing the camera settings 61

- Holding the camera 44
 Settings display 394
- Cards 3, 19, 31, 57
 Card reminder 32
 Formatting 57
 Low-level formatting 58
 Problems 33, 58
 Write-protect switch 31
- Center-weighted average
 metering 166
- Charger 26, 28
- Chromatic aberration correction... 147
- Cleaning (image sensor) 339
- Clearing the camera settings 61
- Close-up 84
- Color space 155
- Color temperature 134, 137
- Color tone 130
- Continuous file numbering 151
- Continuous shooting 111
- Contrast 130
- Copyright information 153
- Creative Auto 78
- Creative filters 224, 335
- ☆ (Creative Zone) icon 8
- Creative Zone modes 24
- Cropping (for printing) 353
- Cross-type focusing 108
- Custom Controls 51, 383
- Custom Functions 362
- Custom shooting modes 390
- Custom white balance 135
- D**
- Date/Time 37
- Daylight saving time 38
- DC Coupler 400
- Depth-of-field preview .. 163, 216, 221
- Dials
 Main Dial 46
 Mode Dial 24, 46
 Quick Control Dial 47
- DIGITAL (USB) terminal 346, 454
- Dioptric adjustment 44
- Direct printing 346
- Direct selection (of AF point) 386
- DPOF 355
- Dragging 55
- Drive mode 80, 111
- Dust Delete Data 341
- E**
- Electronic level 65, 388
- Erasing images 322
- Error codes 432
- Evaluative metering 165
- exFAT 58
- Exposure compensation 167
- Exposure level increments 365
- Exposure level indicator 23, 395
- Exposure simulation 230
- External Speedlite → Flash
- Eyecup 183
- Eye-Fi cards 401
- Eyepiece cover 27
- F**
- FE lock 192, 193
- Feature guide 69
- FEB (flash exposure bracketing) .. 201
- File extension 152
- File name 151

File size..... 117, 266, 292
 Filter effects 131, 335
 Final image simulation 221, 260
 Fine
 (image-recording quality) 117, 118
 Firmware version 414
 First-curtain synchronization 200
 Fish-eye effect 226, 337
 Flash (Speedlite)
 Built-in flash 188
 Custom Functions 202
 Effective range 189
 External flash 193
 FE lock 192, 193
 Flash control 195
 Flash exposure
 compensation 190, 193, 201
 Flash mode 199
 Flash off 77, 80
 Flash sync contacts 20
 Flash sync speed 194
 Manual flash 199, 213
 Red-eye reduction 190
 Shutter synchronization
 (1st/2nd curtain) 200
 Wireless 200
 Focus confirmation light 72
 Focus lock 75
 Focus mode switch 40, 110, 247
 Focusing → AF, Manual focusing
 Folder creation/selection 149
 Formatting (card initialization) 57
 Frame rate 265
 Full High-Definition
 (Full HD) 251, 265, 306, 316
 Function availability by shooting
 mode 404

G

GPS 412
 Grainy B/W 226, 336
 Grid display 229, 276, 291

H







Handheld Night Scene 87
 HD 265, 306, 316
 HDMI 306, 316
 HDMI CEC 317
 HDR 172
 HDR Backlight Control 88
 Help 70
 High ISO speed noise reduction .. 141
 High-Definition (HD)
 movies 265, 306, 316
 Highlight alert 294
 Highlight detail loss 294
 Highlight tone priority 145
 Histogram (Brightness/RGB) 295
 Hot shoe 20, 193
 Household power 400

I

ICC profile 155
 Illumination (LCD panel) 49
 Image conversion factor 42
 Image dust prevention 339
 Image review time 60
 Image Stabilizer (lens) 43
 Image-recording quality 116
 Images
 AF point display 294
 Auto playback 312
 Auto rotation 325
 Erasing 322
 Highlight alert 294

- Histogram display 295
 - Index 296
 - Jump display
 - (image browsing) 297
 - Magnification 298
 - Manual rotation 301
 - Numbering 151
 - Playback 289
 - Protecting 320
 - Ratings 302
 - Shooting information 292
 - Slide show 312
 - Viewing on a TV set 306, 316
 - Index display 296
 - INFO. button 218, 258, 290, 394
 - IPB 265
 - ISO speed 120, 254, 257
 - Automatic setting (Auto) 122
 - Automatic setting range 124
 - ISO expansion 123
 - Manual setting range 123
 - Minimum shutter speed 125
 - Setting increments 365
- J**
- JPEG 116
 - Jump display 297
- L**
- Landscape 83
 - Language 39
 - Large
 - (image-recording quality) 117, 333
 - LCD monitor 19, 34
 - Brightness adjustment 324
 - Electronic level 65
 - Image playback 289
 - Menu display 52, 408
 - Shooting function settings .. 49, 395
 - Vari-Angle 34, 76
 - LCD panel 22
 - Lens 25, 40
 - Chromatic aberration
 - correction 147
 - Image stabilizer 43
 - Instruction Manual CD-ROM
 - Lock release 41
 - Peripheral illumination
 - correction 146
 - Lens hood 42
 - Lighting/scene-based shots 96
 - Live View shooting 76, 215
 - Aspect ratio 229
 - Exposure simulation 230
 - Face+Tracking 233
 - FlexiZone - Multi 236
 - FlexiZone - Single 238
 - Grid display 229
 - Information display 218
 - Metering timer 232
 - Possible shots 217
 - Quick Control 223
 - Quick mode 243
 - Single shooting 231
 - LOCK 48
 - Long exposure noise reduction 143
 - Long exposures 171
- M**
- M (Manual exposure) 164, 256
 - Macro photography 84
 - Magnification 247, 298
 - Main Dial 46
 - Malfunction 418
 - Manual exposure 164, 256
 - Manual focusing (MF) 110, 247
 - Manual reset 152
 - Manual selection (AF) 105

- Maximum burst 117, 119
- Medium
(image-recording quality) 117, 333
- Memory cards → Cards
- Menu 52
 - My Menu 389
 - Setting procedure 53
 - Settings 408
- MENU** icon 8
- Metering mode 165
- Metering timer 232
- Microadjustment 377
- Microphone 252, 269
- Miniature effect 227, 337
- Mirror lockup 182
- Mode Dial 24, 46
- Monochrome images 92, 127, 131
- Movies 251
 - AE lock 253
 - AF method 263, 273
 - Attenuator 268
 - Autoexposure shooting 252
 - Compression method 265
 - Drop frame 272
 - Editing 310
 - External microphone 269
 - File size 266
 - Frame rate 265
 - Grid display 276
 - Information display 258
 - Manual exposure shooting 256
 - Metering timer 275
 - Microphone 252, 269
 - Movie digital zoom 267
 - Movie recording size 265
 - Playback 306, 308
 - Quick Control 264
 - Recording time 266
 - Silent shooting 275
 - Sound recording 268
 - Still photo shooting 261
 - Time code 270
 - Video snapshot album 277
 - Video snapshots 277
 - Viewing on a TV set 306, 316
 - Wind filter 268
- M-RAW (Medium RAW) 117, 118
- Multi Shot Noise Reduction 141
- Multi-controller 48
- Multi function lock 48
- Multiple exposures 175
- My Menu 389
- N**
- Night Portrait 86
- Night scenes 86, 87
- Noise reduction
 - High ISO speed 141
 - Long exposures 143
- Nomenclature 20
- Non-Canon flash units 194
- Normal
(image-recording quality) 117, 118
- NTSC 265, 413
- O**
- ONE SHOT (One-Shot AF) 101
- P**
- P (Program AE) 158
- PAL 265, 413
- Partial metering 166
- Peripheral illumination correction . 146
- Personal white balance 136
- Photobook set-up 359
- PictBridge 345

- Picture Style 126, 129, 132
- Pixels 116
- Playback 289
- Portrait 82
- Possible shots 36, 217
- Power
- Auto power off 59
 - Battery check 36, 396
 - Battery information 396
 - Household power 400
 - Possible shots 36, 217
 - Recharge performance 396
 - Recharging 28
- Pressing completely 45
- Pressing halfway 45
- Printing 345
- Cropping 353
 - Page Layout 349
 - Paper settings 349
 - Photobook set-up 359
 - Print order (DPOF) 355
 - Printing effects 350
 - Tilt correction 353
- Program AE 158
- Program shift 159
- Protecting images 320
- Q**
-  (Quick Control) 50, 90, 223, 264, 304
- Quick Control Dial 47
- Quick mode 243
- R**
- Rating mark 302
- RAW 117, 118
- RAW image processing 328
- RAW+JPEG 116
- Recharging 28
- Recording level 268
- Red-eye reduction 190
- Reduced display 296
- Release shutter without card 32
- Remote control shooting 184
- Remote switch 184
- Resizing 333
- Rotation (image) 301, 325, 353
- S**
- Safety shift 367
- Safety warnings 445
- Saturation 130
- Scene icons 220, 255
- Scene Intelligent Auto 72
- SD, SDHC, SDXC cards → Cards
- Second-curtain synchronization ... 200
- Self-timer 113, 185
- Sensor cleaning 339
- Sepia (monochrome) 92, 131
- Sharpness 130
- Shooting function settings 49, 395
- Shooting information display 292
- Shooting modes 24
- Av (Aperture-priority AE) 162
 - B (Bulb) 171
 - C (Custom shooting) 390
 - M (Manual exposure) 164
 - P (Program AE) 158
 - Tv (Shutter-priority AE) 160
 -  (Scene Intelligent Auto) 72
 -  (Flash Off) 77
 -  (Creative Auto) 78
 - SCN (Special scene) 81
 -  (Portrait) 82
 -  (Landscape) 83

- 📷 (Close-up)..... 84
 - 🏃 (Sports)..... 85
 - 🌃 (Night Portrait)..... 86
 - 📷 (Handheld Night Scene)..... 87
 - 📷 (HDR Backlight Control)..... 88
 - Shooting orientation registration... 373
 - Shutter button 45
 - Shutter synchronization 200
 - Shutter-priority AE 160
 - Silent shooting 80, 111
 - Continuous shooting..... 80, 111
 - Silent LV shooting..... 231
 - Single shooting 111
 - Single-image display..... 290
 - Single-point AF 103
 - Slide show 312
 - Small
(image-recording quality) 117, 333
 - Soft focus..... 226, 336
 - Software..... 456
 - Speaker..... 308
 - Special scene mode..... 81
 - Sports..... 85
 - Spot metering..... 166
 - S-RAW (Small RAW) 117, 118
 - sRGB 155
 - Strap 27
 - System map..... 416
- T**
- Tap 54
 - Temperature warning 249, 287
 - Time code 270
 - Time zone 37
 - Toning effect (monochrome) 131
 - Touch beeping 55
 - Touch screen 54, 299
 - Touch Shutter 245
 - Toy camera effect 227, 337
 - Tripod socket..... 21
 - Tv (Shutter-priority AE) 160
- U**
- USB (DIGITAL) terminal..... 346, 454
- V**
- Vari-Angle LCD monitor 34, 76
 - Video snapshot album..... 277
 - Video snapshots..... 277
 - Video system..... 265, 319, 413
 - Viewfinder 23
 - Dioptric adjustment 44
 - Electronic level..... 65, 388
 - Grid display..... 64
 - Viewing on a TV set 306, 316
 - Volume (movie playback) 309
- W**
- Warning icon 376
 - Water painting effect 226, 337
 - White balance (WB) 134
 - Bracketing..... 139
 - Color temperature setting 137
 - Correction 138
 - Custom 135
 - Personal..... 136
 - Wi-Fi..... 413
 - Wind filter 268
 - Wireless flash shooting 203
- Z**
- Zone AF 103



CANON INC. 30-2, Shimomaruko 3-chome, Ohta-ku, Tokyo 146-8501, Japan

U.S.A. ——— CANON U.S.A. INC.

<http://www.usa.canon.com/eos>

<http://www.usa.canon.com/support>

For all inquiries concerning this product, call toll free in the U.S.
1-800-OK-CANON

CANADA ——— CANON CANADA INC. HEADQUARTERS

6390 Dixie Road, Mississauga, Ontario L5T 1P7, Canada

CANON CANADA INC. MONTREAL BRANCH

5990, Côte-de-Liesse, Montréal Québec H4T 1V7, Canada

CANON CANADA INC. CALGARY OFFICE

2828, 16th Street, N.E. Calgary, Alberta T2E 7K7, Canada

For all inquiries concerning this product, call toll free in Canada
1-800-OK-CANON

EUROPE, ——— CANON EUROPA N.V.

AFRICA & Bovenkerkerweg 59, 1185 XB Amstelveen, The Netherlands

MIDDLE EAST

CANON FRANCE S.A.S.

17, Quai du Président Paul Doumer, 92414 Courbevoie Cedex, France

CANON UK LTD.

Woodhatch Reigate, Surrey RH2 8BF, United Kingdom

CANON DEUTSCHLAND GmbH

Europark Fichtenhain A10, 47807 Krefeld, Germany

CANON ITALIA S.p.A.

Via Milano 8, 20097 San Donato Milanese, (MI), Italy

CANON Schweiz A.G.

Industriestrasse 12, 8305 Dietlikon, Switzerland

Canon GmbH

Zetschegasse 11, A-1230 Vienna, Austria

CANON España, S.A.

Av. De Europa, 6 Alcobendas 28108 Madrid, Spain

CANON Portugal S.A.

Rua Alfredo da Silva, 14 Alfragide 2610-016 Amadora, Portugal

CENTRAL & ——— CANON LATIN AMERICA, INC.

SOUTH AMERICA <http://www.cla.canon.com>

ASIA ——— CANON (China) Co., LTD.

15F Jinbao Building No.89 Jinbao Street, Dongcheng District, Beijing 100005, China

CANON HONGKONG CO., LTD.

19/F., The Metropolis Tower, 10 Metropolis Drive, Hung Hom, Kowloon, Hong Kong

CANON SINGAPORE PTE. LTD.

1 Harbour Front Avenue, #04-01 Keppel Bay Tower, Singapore 098632

CANON KOREA CONSUMER IMAGING INC.

Canon BS Tower 5F, #168-12 Samseong-dong, Gangnam-gu, Seoul, Korea

OCEANIA ——— CANON AUSTRALIA PTY. LTD.

1 Thomas Holt Drive, North Ryde, Sydney N.S.W. 2113, Australia

CANON NEW ZEALAND LTD.

Akoranga Business Park, Akoranga Drive, Northcote, Auckland, New Zealand

JAPAN ——— CANON MARKETING JAPAN INC.

16-6, Kohnan 2-chome, Minato-ku, Tokyo 108-8011, Japan

The lenses and accessories mentioned in this Instruction Manual are current as of April 2013. For information on the camera's compatibility with any lenses and accessories introduced after this date, contact any Canon Service Center.